



Programmable Controller



MELSEC iQ-F
series



MELSEC iQ-F
FX5 User's Manual (Application)

SAFETY PRECAUTIONS

(Read these precautions before use.)

Before using this product, please read this manual and the relevant manuals introduced in this manual carefully and pay full attention to safety in order to handle the product correctly.

This manual classifies the safety precautions into two categories: [ WARNING] and [ CAUTION].

 WARNING	Indicates that incorrect handling may cause hazardous conditions, resulting in death or severe injury.
 CAUTION	Indicates that incorrect handling may cause hazardous conditions, resulting in minor or moderate injury or property damage.

Depending on the circumstances, procedures indicated by [ CAUTION] may also cause severe injury.

It is important to follow all precautions for personal safety.

Store this manual in a safe place so that it can be read whenever necessary. Always forward it to the end user.

[DESIGN PRECAUTIONS]

WARNING

- Make sure to set up the following safety circuits outside the PLC to ensure safe system operation even during external power supply problems or PLC failure. Otherwise, malfunctions may cause serious accidents.
 - Most importantly, set up the following: an emergency stop circuit, a protection circuit, an interlock circuit for opposite movements (such as normal vs. reverse rotation), and an interlock circuit (to prevent damage to the equipment at the upper and lower positioning limits).
 - Note that when the CPU module detects an error, such as a watchdog timer error, during self-diagnosis, all outputs are turned off. Also, when an error that cannot be detected by the CPU module occurs in an input/output control block, output control may be disabled. External circuits and mechanisms should be designed to ensure safe machinery operation in such a case.
 - Note that the output current of the 24 V DC service power supply varies depending on the model and the absence/presence of extension modules. If an overload occurs, the voltage automatically drops, inputs in the PLC are disabled, and all outputs are turned off. External circuits and mechanisms should be designed to ensure safe machinery operation in such a case.
 - Note that when an error occurs in a relay, triac or transistor of an output circuit, the output might stay on or off. For output signals that may lead to serious accidents, external circuits and mechanisms should be designed to ensure safe machinery operation in such a case.
 - Construct an interlock circuit in the program so that the whole system always operates on the safe side before executing the control (for data change) of the PLC in operation.

Read the manual thoroughly and ensure complete safety before executing other controls (for program change, parameter change, forcible output and operation status change) of the PLC in operation. Otherwise, the machine may be damaged and accidents may occur due to erroneous operations.
 - In an output circuit, when a load current exceeding the current rating or an overcurrent caused by a load short-circuit flows for a long time, it may cause smoke and fire. To prevent this, configure an external safety circuit, such as a fuse.
 - For the operating status of each station after a communication failure of the network, refer to relevant manuals for the network. Incorrect output or malfunction may result in an accident.
-

[DESIGN PRECAUTIONS]

CAUTION

- After the CPU module is powered on or is reset, the time taken to enter the RUN status varies depending on the system configuration, parameter settings, and/or program size.
Design circuits so that the entire system will always operate safely, regardless of this variation in time.
-

[SECURITY PRECAUTIONS]

WARNING

- To maintain the security (confidentiality, integrity, and availability) of the programmable controller and the system against unauthorized access, denial-of-service (DoS) attacks, computer viruses, and other cyberattacks from unreliable networks and devices via network, take appropriate measures such as firewalls, virtual private networks (VPNs), and antivirus solutions.
-

[INSTALLATION PRECAUTIONS]

CAUTION

- Connect the expansion board and expansion adapter securely to their designated connectors. Loose connections may cause malfunctions.
 - Connect the extension cables, peripheral device cables, input/output cables and battery connecting cable securely to their designated connectors. Loose connections may cause malfunctions.
 - When using an SD memory card, insert it into the SD memory card slot. Check that it is inserted completely. Poor contact may cause malfunction.
 - Turn off the power to the PLC before attaching or detaching the following devices. Failure to do so may cause device failures or malfunctions.
 - Peripheral devices, expansion board, expansion adapter, and connector conversion adapter
 - Extension modules, bus conversion module, and connector conversion module
 - Battery
-

[WIRING PRECAUTIONS]

CAUTION

- Do not bundle the power line, control line and communication cables together with or lay them close to the main circuit, high-voltage line, load line or power line. As a guideline, lay the power line, control line and connection cables at least 100 mm away from the main circuit, high-voltage line, load line or power line.
-

[STARTUP AND MAINTENANCE PRECAUTIONS]

WARNING

- Do not touch any terminal while the PLC's power is on. Doing so may cause electric shock or malfunctions.
 - Before modifying the program in operation, forcible output, running or stopping the PLC, read through this manual carefully, and ensure complete safety. An operation error may damage the machinery or cause accidents.
 - Do not change the program in the PLC from two or more peripheral equipment devices at the same time. (i.e. from an engineering tool and a GOT) Doing so may cause destruction or malfunction of the PLC program.
 - Use the battery for memory backup in conformance to the User's Manual (Hardware) of the CPU module used.
 - Use the battery for the specified purpose only.
 - Connect the battery correctly.
 - Do not charge, disassemble, heat, put in fire, short-circuit, connect reversely, weld, swallow or burn the battery, or apply excessive forces (vibration, impact, drop, etc.) to the battery.
 - Do not store or use the battery at high temperatures or expose to direct sunlight.
 - Do not expose to water, bring near fire or touch liquid leakage or other contents directly.
- Incorrect handling of the battery may cause heat excessive generation, bursting, ignition, liquid leakage or deformation, and lead to injury, fire or failures and malfunction of facilities and other equipment.
-

[OPERATION PRECAUTIONS]

CAUTION

- Construct an interlock circuit in the program so that the whole system always operates on the safe side before executing the control (for data change) of the PLC in operation. Read the manual thoroughly and ensure complete safety before executing other controls (for program change, parameter change, forcible output and operation status change) to the PLC in operation. Otherwise, the machine may be damaged and accidents may occur by erroneous operations.
-

INTRODUCTION

This manual contains text, diagrams and explanations which will guide the reader in the correct installation, safe use and operation of the FX5 Programmable Controllers and should be read and understood before attempting to install or use the module.

Always forward it to the end user.

Regarding use of this product

- This product has been manufactured as a general-purpose part for general industries, and has not been designed or manufactured to be incorporated in a device or system used in purposes related to human life.
- Before using the product for special purposes such as nuclear power, electric power, aerospace, medicine or passenger movement vehicles, consult Mitsubishi Electric.
- This product has been manufactured under strict quality control. However when installing the product where major accidents or losses could occur if the product fails, install appropriate backup or failsafe functions in the system.

Note

- If in doubt at any stage during the installation of the product, always consult a professional electrical engineer who is qualified and trained in the local and national standards. If in doubt about the operation or use, please consult the nearest Mitsubishi Electric representative.
- Since the examples indicated by this manual, technical bulletin, catalog, etc. are used as a reference, please use it after confirming the function and safety of the equipment and system. Mitsubishi Electric will accept no responsibility for actual use of the product based on these illustrative examples.
- This manual content, specification etc. may be changed without a notice for improvement.
- The information in this manual has been carefully checked and is believed to be accurate; however, if you notice a doubtful point, an error, etc., please contact the nearest Mitsubishi Electric representative. When doing so, please provide the manual number given at the end of this manual.

MEMO

CONTENTS

SAFETY PRECAUTIONS	1
INTRODUCTION	4
RELEVANT MANUALS	14
TERMS	15

PART 1 PROGRAMMING

CHAPTER 1 PROGRAM EXECUTION 18

1.1 Scan Configuration	18
Initial processing and initialization processing in RUN mode	18
I/O refresh	19
Program operations	19
END processing	19
1.2 Scan Time	20
Initial scan time	20
1.3 Program Execution Sequence	21
1.4 Execution Type of Program	22
Initial execution type program	22
Scan execution type program	23
Fixed scan execution type program	23
Event execution type program	28
Stand-by type program	31
1.5 Program Type	32
Subroutine program	32
Interrupt program	33

CHAPTER 2 PROCESSING OF OPERATIONS ACCORDING TO CPU MODULE OPERATION STATUS 39

CHAPTER 3 CPU MODULE MEMORY CONFIGURATION 41

3.1 Memory Configuration	41
Memory configuration	41
3.2 Files	45
File type and storage destination memory	45
Executable file operations	46
3.3 Memory Operation	47
Initialization and value clear	47

PART 2 FUNCTIONS

CHAPTER 4 FUNCTION LIST 51

CHAPTER 5 FIRMWARE UPDATE FUNCTION 53

5.1 Update Using an SD Memory Card	53
CPU module firmware update	54
5.2 Update Using the Engineering tool	60

CHAPTER 6	SCAN MONITORING FUNCTION	66
6.1	Scan time monitoring time setting	66
6.2	Resetting of the watchdog timer	66
6.3	Precautions	66
	Watchdog timer reset when executing a program repeatedly	66
	Scan time when the WDT instruction is used	67
CHAPTER 7	CLOCK FUNCTION	68
7.1	Time Setting	68
	Clock data	68
	Changing the clock data	68
	Reading clock data	69
	Precautions	69
7.2	Setting Time Zone	70
7.3	System clock	71
	Special relay used for system clock	71
	Special register used for system clock	71
CHAPTER 8	ONLINE CHANGE	72
8.1	Online Ladder Block Change	72
	Editable contents	72
	Range changeable in a single session	72
	Online ladder block change during the boot operation	72
	Precautions	72
CHAPTER 9	INTERRUPT FUNCTION	75
9.1	Multiple Interrupt Function	75
	Interrupt priority	75
CHAPTER 10	PID CONTROL FUNCTION	77
10.1	Outline of Function	77
10.2	Basic Operation Expressions in PID Instruction	78
	Basic operation expression for PID control	78
10.3	How to Use PID Instruction	79
10.4	Relationship Between Parameter Setting and Auto-Tuning	80
	When auto-tuning is not executed (parameter setting)	80
	When auto-tuning is executed	80
10.5	Parameter	81
10.6	Details of Parameters	82
	Sampling time (s3)	82
	Operation setting (s3)+1	83
	Input filter constant (s3)+2	86
	Proportional gain (s3)+3	87
	Integral time (s3)+4	88
	Differential gain (s3)+5	89
	Differential time (s3)+6	90
	Alarm output (s3)+24	92
10.7	Auto-Tuning	93
	Limit Cycle Method	93
	Step Response Method	96

10.8	Examples of Program	98
	System configuration example	98
	Program example 1	99
	Program example 2	101
	Program example 3	103
	Program example 4	105
	Program example 5	107
10.9	Example of parameter adjustment and the effect on PID control operation	109
	Improvement of control results	109
CHAPTER 11 CONSTANT SCAN		114
11.1	Constant scan settings	114
CHAPTER 12 REMOTE OPERATION		116
12.1	Remote RUN/STOP	116
	Applications of remote RUN/STOP	116
	Operation during remote RUN/STOP	116
	Method of execution of remote RUN/STOP	116
12.2	Remote PAUSE	118
	Application of remote PAUSE	118
	Method of execution of remote PAUSE	118
12.3	Remote RESET	119
	Application of remote RESET	119
	Enabling remote RESET	119
	Method of execution of remote RESET	119
12.4	Relationship Between Remote Operation and CPU Module	120
CHAPTER 13 DEVICE/LABEL MEMORY AREA SETTING		121
13.1	Default Capacity of Each Area	121
13.2	The Setting Range of the Capacity of Each Area	122
13.3	Device/Label Memory Area Setting	123
13.4	Device Setting	124
	Range of use of device points	125
CHAPTER 14 PROGRAM CAPACITY SETTING		127
CHAPTER 15 INTERNAL BUFFER CAPACITY SETTING		128
CHAPTER 16 INITIAL DEVICE VALUE SETTING		130
16.1	Setting Initial Device Values	130
	Setting initial device values	130
16.2	Applicable Devices	131
CHAPTER 17 LATCH FUNCTION		132
17.1	Types of Latch	132
17.2	Device/label that can be Latched	132
17.3	Latch Settings	134
	Latch settings	134
	Setting latch on labels	135
17.4	Clearing of Data of the Latch Range	135

17.5	Precautions	136
CHAPTER 18 MEMORY CARD FUNCTION		137
18.1	SD Memory Card Forced Stop	137
18.2	Boot Operation	139
CHAPTER 19 DEVICE/LABEL ACCESS SERVICE PROCESSING SETTING		141
CHAPTER 20 DATA LOGGING FUNCTION		144
20.1	Specifications List	145
20.2	Details of Specifications	146
	Logging type	146
	Data collection conditions	148
	Target data	151
	Trigger condition	152
	Data logging file	153
	Saving and file switching	160
	Setting the operation at the time of transition to RUN	165
20.3	Procedure for Using	166
	Data logging setting	167
	Writing the data logging setting	168
	Executing data logging	169
	Checking the data logging file	170
20.4	Data Logging Execution by Special Relay	171
20.5	Precautions	172
20.6	SD Memory card Life and Replacement	176
	SD memory card life	176
	SD memory card replacement	177
CHAPTER 21 MEMORY DUMP FUNCTION		179
21.1	Object Data	180
	Data to be collected	180
21.2	Trigger Condition	180
	Device specification	181
	At the occurrence of an error	181
	Combining trigger conditions	182
21.3	Procedure for Memory Dump	183
21.4	Flow of Data Collection	183
	Effect on the scan time	183
21.5	Memory Dump File	184
	Save file name	184
21.6	States of the Memory Dump Function	184
	Memory dump status	184
21.7	Sizes of Files Used for the Memory Dump Function	185
	Capacity of the memory dump setting file	185
	Capacity of the memory dump file	185
21.8	Special Relay and Special Register Used in the Memory Dump Function	186
21.9	Precautions for the Memory Dump Function	186
CHAPTER 22 REAL-TIME MONITOR FUNCTION		188

CHAPTER 23 RAS FUNCTIONS	190
23.1 Self-Diagnostics Function	190
Self-diagnostics timing	190
Check method of error	190
CPU Module Operation Upon Error Detection Setting	191
Error Clear	193
23.2 Event History Function	194
Event history settings	195
Logging of the event history	195
Viewing the event history	198
Clearing the event history	198
Precautions	198
CHAPTER 24 DATA BACKUP/RESTORATION FUNCTION	199
24.1 Backup Function	203
Backup processing triggered by turning on SM1351 (Normal Mode)	205
Backup processing triggered by turning on SM1351 (CPU module auto exchange function)	206
Checking backup errors	207
Precautions	208
24.2 Restoration Function	210
Restoration processing triggered by turning on SM1354	212
Automatic restoration using SD955	213
Restoration triggered by CPU module auto exchange	214
Checking restoration errors	214
Precautions	215
CHAPTER 25 SECURITY FUNCTIONS	219
CHAPTER 26 HIGH-SPEED INPUT/OUTPUT FUNCTION	220
26.1 High-speed Counter Function	220
High-speed counter function overview	220
High-speed counter function execution procedure	222
High-speed counter specifications	222
Assignment for high-speed counters	227
High-speed counter parameters	235
High-speed counter (normal mode)	236
High-speed counter (pulse density measurement mode)	239
High-speed counter (rotational speed measurement mode)	242
High-speed comparison table	244
Multiple point output, high-speed comparison tables	247
Special relay list	250
Special relay details	255
Special registers list	264
Special register details	272
Special relays/special registers capable of high-speed transfers with the HCMOV/DHCMOV instruction	283
Precautions when using high-speed counters	286
26.2 FX3-compatible high-speed counter function	292
FX3-compatible high-speed counter function overview	292
How to start/stop the high-speed counter using the LC device	292
The elements of the composition of the LC device	293

	The comparison between the UDCNTF instruction and HIOEN/DHIOEN instruction	293
	Assignment for FX3-compatible high-speed counters	295
	FX3-compatible high-speed counter setting	297
	FX3-compatible high-speed counter	297
	Special relay list	299
	Special relays/LC devices capable of high-speed transfers with the HCMOV/DHCMOV instruction	300
	Precautions when using FX3-compatible high-speed counters	301
26.3	Pulse Width Measurement Function	302
	Pulse width measurement function overview	302
	Pulse width measurement specifications	302
	Pulse measurement function execution procedure	305
	Pulse width measurement parameters	305
	List of special relays/special registers	307
	Details of special relays/special registers	312
	Cautions when using the pulse width measurement function	317
	Examples of program	318
26.4	Pulse Catch Function	319
	Outline of pulse catch function	319
	Specifications of pulse catch function	319
	Pulse catch function execution procedure	320
	Pulse catch parameters	321
	Operation of pulse catch function	323
	Cautions when using the pulse catch function	324
26.5	FX3-Compatible Pulse Catch Function	325
	Outline of FX3-compatible pulse catch function	325
	Specifications of FX3-compatible pulse catch function	325
	FX3-compatible pulse catch function execution procedure	326
	FX3-compatible pulse catch parameters	327
	Operation of FX3-compatible pulse catch function	328
	Cautions when using the FX3-compatible pulse catch function	328
26.6	General-purpose Input Functions	329
	Outline of general-purpose input functions	329
	Specifications of general-purpose inputs	329
	General-purpose input function parameters	331
26.7	PWM Function	332
	Outline of PWM output	332
	PWM output specifications	332
	PWM output function execution procedure	335
	PWM output parameters	335
	List of Special relays/special registers	338
	Details of special relays/special registers	340
	Cautions when using the PWM function	343
	Examples of program	344
CHAPTER 27 BUILT-IN ANALOG FUNCTION		346
27.1	Function Outline	346
27.2	Analog Input/Output Specifications	346
	Analog input specifications	346
	Analog output specifications	346
	List of analog input functions	347

List of analog output functions	347
---	-----

PART 3 DEVICES/LABELS

CHAPTER 28 DEVICES 350

28.1 List of Devices	350
28.2 User Devices	351
Input (X)	351
Output (Y)	351
Internal relay (M)	352
Latch relay (L)	352
Link relay (B)	352
Annunciator (F)	352
Link special relay (SB)	354
Step relay (S)	354
Timer (T/ST)	355
Counter (C/LC)	358
Data register (D)	360
Link register (W)	360
Link special register (SW)	360
28.3 System Devices	360
Special relay (SM)	360
Special register (SD)	360
28.4 Module Access Device	361
Specification method	361
Processing speed	361
28.5 Index Registers (Z/LZ)	362
Types of index registers	362
Device for which Index modification can be performed	362
Index register setting	363
28.6 File Register (R/ER)	364
Types of file register	364
Extended file register (ER) function	364
28.7 Nesting (N)	368
28.8 Pointer (P)	368
Global pointers	369
Label assignment pointers	369
28.9 Interrupt Pointer (I)	369
Interrupt causes of the interrupt pointer numbers	369
The priority for the interrupt pointer numbers and interrupt factors	370
28.10 SFC Block Device (BL)	371
28.11 SFC Transition Device (TR)	371
28.12 Indirect Specification	371
28.13 Constant	372
Decimal constant (K)	372
Hexadecimal constant (H)	372
Real constant (E)	372
Character string constant	373

CHAPTER 29 LABELS 374

APPENDIX	376
Appendix 1 Special Relay List	376
Appendix 2 Special Register List	410
Appendix 3 Error Code	472
Error code system	472
Operation when an error occurs	473
How to clear errors	473
List of error codes	473
Appendix 4 Parameter List	523
System parameters	523
CPU parameters	523
Module parameters	524
Memory card parameters	532
Appendix 5 Event List	533
How to read the event list	533
Event list	534
Appendix 6 Processing Time	535
Data logging function processing time	535
SFC program processing time	536
Processing time until the file operation is completed	538
Appendix 7 How to Use CPU Module Logging Configuration Tool	540
Screen configuration	542
Menu structure	543
Setting data logging	555
Appendix 8 Substitute Functions	565
File registers	565
Appendix 9 Added and Enhanced Functions	566
 INDEX	 570
REVISIONS	573
WARRANTY	575
TRADEMARKS	576

RELEVANT MANUALS

Manual name <manual number>	Description
MELSEC iQ-F FX5 User's Manual (Startup) <JY997D58201>	Describes the performance specifications, procedures before operation, and troubleshooting of the FX5 CPU module.
MELSEC iQ-F FX5UJ User's Manual (Hardware) <SH-082206ENG>	Describes the details of hardware of the FX5UJ CPU module, including input/output specifications, wiring, installation, and maintenance.
MELSEC iQ-F FX5U User's Manual (Hardware) <JY997D55301>	Describes the details of hardware of the FX5U CPU module, including input/output specifications, wiring, installation, and maintenance.
MELSEC iQ-F FX5UC User's Manual (Hardware) <JY997D61401>	Describes the details of hardware of the FX5UC CPU module, including input/output specifications, wiring, installation, and maintenance.
MELSEC iQ-F FX5 User's Manual (Application) <JY997D55401> (This manual)	Describes the basic knowledge required for program design, functions of the CPU module, devices/labels, and parameters.
MELSEC iQ-F FX5 Programming Manual (Program Design) <JY997D55701>	Describes the specifications of ladder, ST, FBD/LD, and SFC programs, and labels.
MELSEC iQ-F FX5 Programming Manual (Instructions, Standard Functions/Function Blocks) <JY997D55801>	Describes the specifications of instructions and functions that can be used in programs.
MELSEC iQ-F FX5 User's Manual (Serial Communication) <JY997D55901>	Describes the N:N network, Parallel link, MELSEC Communication protocol, inverter communication, non-protocol communication, and predefined protocol support.
MELSEC iQ-F FX5 User's Manual (MELSEC Communication Protocol) <JY997D60801>	Explains methods for the device that is communicating with the CPU module by MC protocol to read and write the data of the CPU module.
MELSEC iQ-F FX5 User's Manual (MODBUS Communication) <JY997D56101>	Describes the MODBUS serial communication and MODBUS/TCP communication.
MELSEC iQ-F FX5 User's Manual (PROFIBUS) <SH-081910ENG>	Describes the PROFIBUS-DP master module.
MELSEC iQ-F FX5 User's Manual (Ethernet Communication) <JY997D56201>	Describes the Ethernet communication function of the CPU module built-in and the Ethernet module.
MELSEC iQ-F FX5-ENET User's Manual <SH-082026ENG>	Describes the FX5-ENET.
MELSEC iQ-F FX5-ENET/IP User's Manual <SH-082027ENG>	Describes the FX5-ENET/IP.
MELSEC iQ-F FX5 User's Manual (BACnet) <SH-082218ENG>	BACnet functions of the Ethernet module.
MELSEC iQ-F FX5 User's Manual (SLMP) <JY997D56001>	Explains methods for the device that is communicating with the CPU module by SLMP to read and write the data of the CPU module.
MELSEC iQ-F FX5 User's Manual (CC-Link IE TSN) <SH-082215ENG>	Describes the CC-Link IE TSN module.
MELSEC iQ-F FX5 User's Manual (CC-Link IE) <JY997D64201>	Describes the CC-Link IE field network module.
MELSEC iQ-F FX5 User's Manual (CC-Link) <SH-081793ENG>	Describes the CC-Link system master/intelligent device module.
MELSEC iQ-F FX5 User's Manual (AnyWireASLINK) <SH-081796ENG>	Describes the AnyWireASLINK system master module.
MELSEC iQ-F FX5 User's Manual (Positioning Control - CPU module built-in, High-speed pulse input/output module) <JY997D56301>	Describes the positioning function of the CPU module built-in and the high-speed pulse input/output module.
MELSEC iQ-F FX5 User's Manual (Positioning Control - Intelligent function module) <SH-081805ENG>	Describes the positioning module.
MELSEC iQ-F FX5 Motion Module/Simple Motion Module User's Manual (Startup) <IB0300251>	Describes the specifications, procedures before operation, system configuration, wiring, and operation examples of the Motion module/Simple Motion module.
MELSEC iQ-F FX5 Motion Module/Simple Motion Module User's Manual (Application) <IB0300253>	Describes the functions, input/output signals, buffer memories, parameter settings, programming, and troubleshooting of the Motion module/Simple Motion module.
MELSEC iQ-F FX5 Motion Module/Simple Motion Module User's Manual (Advanced Synchronous Control) <IB0300255>	Describes the functions and programming for the synchronous control of the Motion module/Simple Motion module.
MELSEC iQ-F FX5 Motion Module User's Manual (CC-Link IE TSN) <IB0300568>	Describes the functions, parameter settings, troubleshooting, and buffer memories of the CC-Link IE TSN network.

Manual name <manual number>	Description
MELSEC iQ-F FX5 User's Manual (Analog Control - CPU module built-in, Expansion adapter) <JY997D60501>	Describes the analog function of the CPU module built-in and the analog adapter.
MELSEC iQ-F FX5 User's Manual (Analog Control - Intelligent function module) <SH-081802ENG>	Describes the analog input module, analog output module, and multiple input module.
MELSEC iQ-F FX5 User's Manual (Temperature Control) <SH-081799ENG>	Describes the temperature control module.
MELSEC iQ-F FX5 User's Manual (Safety Control) <SH-082078ENG>	Describes the safety extension modules.
GX Works3 Operating Manual <SH-081215ENG>	Describes the system configuration, parameter settings, and online operations of GX Works3.
Transition from MELSEC FX3G, FX3U, FX3UC Series to MELSEC iQ-F Series Handbook <JY997D66201>	Describes the transition from MELSEC FX3G/FX3U/FX3UC series to MELSEC iQ-F series.

TERMS

Unless otherwise specified, this manual uses the following terms.

For details on the FX3 devices that can be connected with the FX5, refer to the User's Manual (Hardware) of the CPU module to be used.

Terms	Description
■Devices	
FX5	Generic term for FX5UJ, FX5U and FX5UC PLCs
FX3	Generic term for FX3S, FX3G, FX3GC, FX3U, and FX3UC PLCs
FX5 CPU module	Generic term for FX5UJ CPU module, FX5U CPU module and FX5UC CPU module
FX5UJ CPU module	Generic term for FX5UJ-24MR/ES, FX5UJ-24MT/ES, FX5UJ-24MT/ESS, FX5UJ-40MR/ES, FX5UJ-40MT/ES, FX5UJ-40MT/ESS, FX5UJ-60MR/ES, FX5UJ-60MT/ES, and FX5UJ-60MT/ESS
FX5U CPU module	Generic term for FX5U-32MR/ES, FX5U-32MT/ES, FX5U-32MT/ESS, FX5U-64MR/ES, FX5U-64MT/ES, FX5U-64MT/ESS, FX5U-80MR/ES, FX5U-80MT/ES, FX5U-80MT/ESS, FX5U-32MR/DS, FX5U-32MT/DS, FX5U-32MT/DSS, FX5U-64MR/DS, FX5U-64MT/DS, FX5U-64MT/DSS, FX5U-80MR/DS, FX5U-80MT/DS, and FX5U-80MT/DSS
FX5UC CPU module	Generic term for FX5UC-32MT/D, FX5UC-32MT/DSS, FX5UC-64MT/D, FX5UC-64MT/DSS, FX5UC-96MT/D, FX5UC-96MT/DSS, FX5UC-32MT/DS-TS, FX5UC-32MT/DSS-TS, and FX5UC-32MR/DS-TS
Extension module	Generic term for FX5 extension modules, FX3 function modules, Extension modules (extension cable type) and Extension module (extension connector type)
FX5 extension module	Generic term for I/O modules, FX5 extension power supply modules, FX5 intelligent function modules, and FX5 safety extension modules
FX3 extension module	Generic term for FX3 extension power supply module and FX3 intelligent function module
Extension module (extension cable type)	Generic term for Input modules (extension cable type), Output modules (extension cable type), Input/output modules (extension cable type), Powered input/output module, High-speed pulse input/output module, Extension power supply module (extension cable type), Connector conversion module (extension cable type), Intelligent function modules, Safety extension modules, and Bus conversion module (extension cable type)
Extension module (extension connector type)	Generic term for Input modules (extension connector type), Output modules (extension connector type), Input/output modules (extension connector type), Extension power supply module (extension connector type), Connector conversion module (extension connector type), and Bus conversion module (extension connector type)
I/O module	Generic term for Input modules, Output modules, Input/output modules, Powered input/output modules, and High-speed pulse input/output modules
Input module	Generic term for Input modules (extension cable type) and Input modules (extension connector type)
Input module (extension cable type)	Generic term for FX5-8EX/ES and FX5-16EX/ES
Input module (extension connector type)	Generic term for FX5-C16EX/D, FX5-C16EX/DS, FX5-C32EX/D, FX5-C32EX/DS, and FX5-C32EX/DS-TS
Output module	Generic term for Output modules (extension cable type) and Output modules (extension connector type)
Output module (extension cable type)	Generic term for FX5-8EYR/ES, FX5-8EYT/ES, FX5-8EYT/ESS, FX5-16EYR/ES, FX5-16EYT/ES, and FX5-16EYT/ESS
Output module (extension connector type)	Generic term for FX5-C16EYT/D, FX5-C16EYT/DSS, FX5-C16EYR/D-TS, FX5-C32EYT/D, FX5-C32EYT/DSS, FX5-C32EYT/D-TS, and FX5-C32EYT/DSS-TS
Input/output module	Generic term for Input/output modules (extension cable type) and Input/output modules (extension connector type)
Input/output module (extension cable type)	Generic term for FX5-16ER/ES, FX5-16ET/ES, and FX5-16ET/ESS

Terms	Description
Input/output module (extension connector type)	Generic term for FX5-C32ET/D, FX5-C32ET/DSS, FX5-C32ET/DS-TS, and FX5-C32ET/DSS-TS
Powered input/output module	Generic term for FX5-32ER/ES, FX5-32ET/ES, FX5-32ET/ESS, FX5-32ER/DS, FX5-32ET/DS, and FX5-32ET/DSS
High-speed pulse input/output module	Generic term for FX5-16ET/ES-H and FX5-16ET/ESS-H
Extension power supply module	Generic term for FX5 extension power supply module and FX3 extension power supply module
FX5 extension power supply module	Generic term for FX5 extension power supply module (extension cable type) and FX5 extension power supply module (extension connector type)
FX5 extension power supply module (extension cable type)	Different name for FX5-1PSU-5V
FX5 extension power supply module (extension connector type)	Different name for FX5-C1PS-5V
FX3 extension power supply module	Different name for FX3U-1PSU-5V
Intelligent module	The abbreviation for intelligent function modules
Intelligent function module	Generic term for FX5 intelligent function modules and FX3 intelligent function modules
FX5 intelligent function module	Generic term for FX5-4AD, FX5-4DA, FX5-8AD, FX5-4LC, FX5-20PG-P, FX5-20PG-D, FX5-40SSC-G, FX5-80SSC-G, FX5-40SSC-S, FX5-80SSC-S, FX5-ENET, FX5-ENET/IP, FX5-CCLGN-MS, FX5-CCLIEF, FX5-CCL-MS, FX5-ASL-M, and FX5-DP-M
FX3 intelligent function module	Generic term for FX3U-4AD, FX3U-4DA, FX3U-4LC, FX3U-1PG, FX3U-2HC, FX3U-16CCL-M, FX3U-64CCL, FX3U-128ASL-M, and FX3U-32DP
FX5 safety extension module	Generic term for safety main modules and safety expansion modules
Safety main module	Different name for FX5-SF-MU4T5
Safety expansion module	Generic term for expansion modules installed to a safety main module
Safety input expansion module	Different name for FX5-SF-8DI4
Expansion board	Generic term for board for FX5UJ CPU module and FX5U CPU module
Communication board	Generic term for FX5-232-BD, FX5-485-BD, and FX5-422-BD-GOT
Expansion adapter	Generic term for adapter for FX5 CPU module
Communication adapter	Generic term for FX5-232ADP and FX5-485ADP
Analog adapter	Generic term for FX5-4AD-ADP, FX5-4DA-ADP, FX5-4AD-PT-ADP, FX5-4AD-TC-ADP, and FX5-4A-ADP
Bus conversion module	Generic term for Bus conversion module (extension cable type) and Bus conversion module (extension connector type)
Bus conversion module (extension cable type)	Different name for FX5-CNV-BUS
Bus conversion module (extension connector type)	Different name for FX5-CNV-BUSC
Connector conversion module	Generic term for Connector conversion module (extension cable type) and Connector conversion module (extension connector type)
Connector conversion module (extension cable type)	Different name for FX5-CNV-IF
Connector conversion module (extension connector type)	Different name for FX5-CNV-IFC
Extended extension cable	Generic term for FX5-30EC and FX5-65EC
Connector conversion adapter	Different name for FX5-CNV-BC
Battery	Different name for FX3U-32BL
SD memory card	Generic term for NZ1MEM-2GBSD, NZ1MEM-4GBSD, NZ1MEM-8GBSD, NZ1MEM-16GBSD, L1MEM-2GBSD and L1MEM-4GBSD SD memory cards Abbreviation of Secure Digital Memory Card. Device that stores data using flash memory.
Peripheral device	Generic term for engineering tools and GOTs
GOT	Generic term for Mitsubishi Electric Graphic Operation Terminal GOT1000 and GOT2000 series
■Software packages	
Engineering tool	The product name of the software package for the MELSEC programmable controllers
GX Works3	The product name of the software package, SWnDND-GXW3, for the MELSEC programmable controllers (The 'n' represents a version.)

This part consists of the following chapters.

1 PROGRAM EXECUTION

2 PROCESSING OF OPERATIONS ACCORDING TO CPU MODULE OPERATION STATUS

3 CPU MODULE MEMORY CONFIGURATION

1 PROGRAM EXECUTION

1.1 Scan Configuration

The configuration of the scan of the CPU module is explained below.

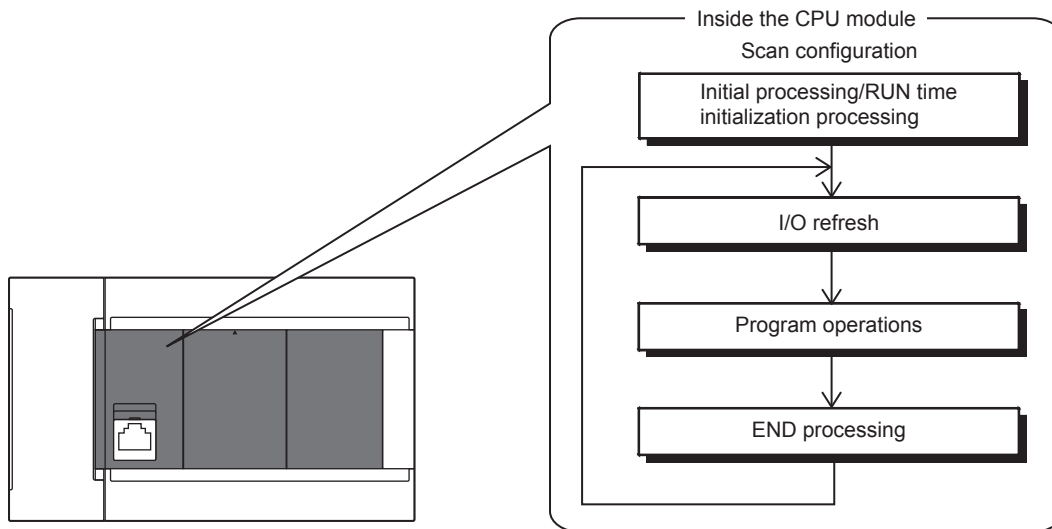

Initial processing and initialization processing in RUN mode

Initial processing according to CPU module status and initialization processing in the RUN status are explained below.

○: Execute, ×: Do not execute

Processing item	CPU module status			
	At power ON	At reset	STOP→RUN after write to PLC*1	At STOP→RUN
Initialization of input/output module	○	○	×	×
Boot from SD memory card	○	○	×	×
CPU parameter check	○	○	×	×
System parameter check	○	○	×	×
Initialization of device/label outside latch range (bit device: OFF, word device: 0)	○	○	×	×
Assignment of I/O numbers of input/output module	○	○	×	×
Setting of module parameters	○	○	×	×
Setting of device	○	○	○	○

*1 Indicates an instance of power OFF→ON or setting to RUN status without a reset after modifying parameters or program in STOP status.

Point

At STOP→RUN after writing to the FX5U/FX5UC CPU module, the following operations are added in CPU module firmware version "1.015" or later. The FX5UJ CPU unit is supported from the first version.

- When stored in CPU module: Update program file, FB files, global label setting file, initial device value file
- When stored in SD memory card: Update initial device value file

However, if other parameters are changed, the above is not updated. To update, please perform power supply OFF→ON or reset.

I/O refresh

Execute I/O refresh before starting program operations.

- Input ON/OFF data input from input module/intelligent function module to CPU module
- Output ON/OFF data input from CPU module to output module/intelligent function module



When executing constant scan, I/O refresh is executed after the constant scan waiting time ends.

Program operations

Step 0 of each program up to the END/FEND instruction is executed according to program settings. This program is called the "main routine." Main routine programs can be divided into subroutines. ( Page 32 Subroutine program)

END processing

END processing involves the following processes:

- Link refreshing of network modules
- Link refreshing of CC-Link IE Field Network Basic
- Refreshing of intelligent function modules
- Instruction termination processing
- Device/label access service processing
- Resetting of the watchdog timer
- Device collection by the data logging function
- Self-diagnostic processing
- Setting of values to special relays/special registers (set timing: when END processing is executed)

1.2 Scan Time

The CPU module repeats the following processing. The scan time is the sum total of each process and execution time.

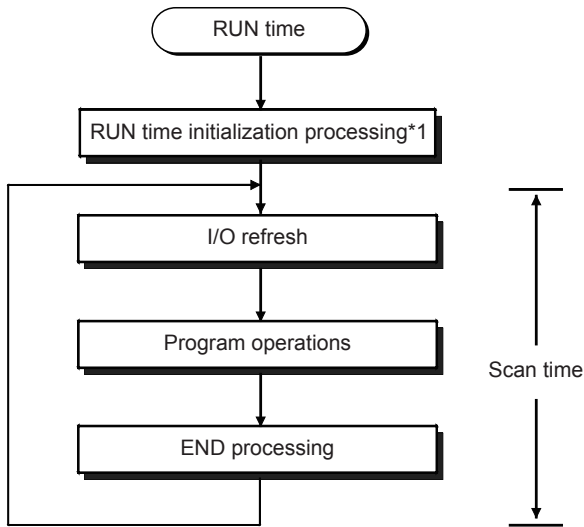

*1 This process is included in the initial scan time.

Initial scan time

This refers to the initial scan time when the CPU module is in the RUN mode.

How to check the initial scan time

The initial scan time can be checked by the following information:

- Value stored in SD518 (initial scan time (ms)), SD519 (initial scan time (μs))
- Program list monitor (📖GX Works3 Operating Manual)

Monitoring the initial scan time

The initial scan time is monitored by the initial scan time execution monitor time. (👉 6 SCAN MONITORING FUNCTION)

■Initial scan time execution monitor time precautions

- Set an initial execution monitor time longer than the execution time of the initial scan time. An error occurs when the initial scan time exceeds the set initial execution monitor time.
- The measurement error margin of the initial scan execution monitor time is 10 ms. For example, if the initial execution monitor time (t) is set to 100 ms, an error occurs in the initial scan time in the range $100\text{ ms} < t < 110\text{ ms}$ range.

1.3 Program Execution Sequence

When the CPU module enters the RUN status, the programs are executed successively according to the execution type of the programs and execution order setting.

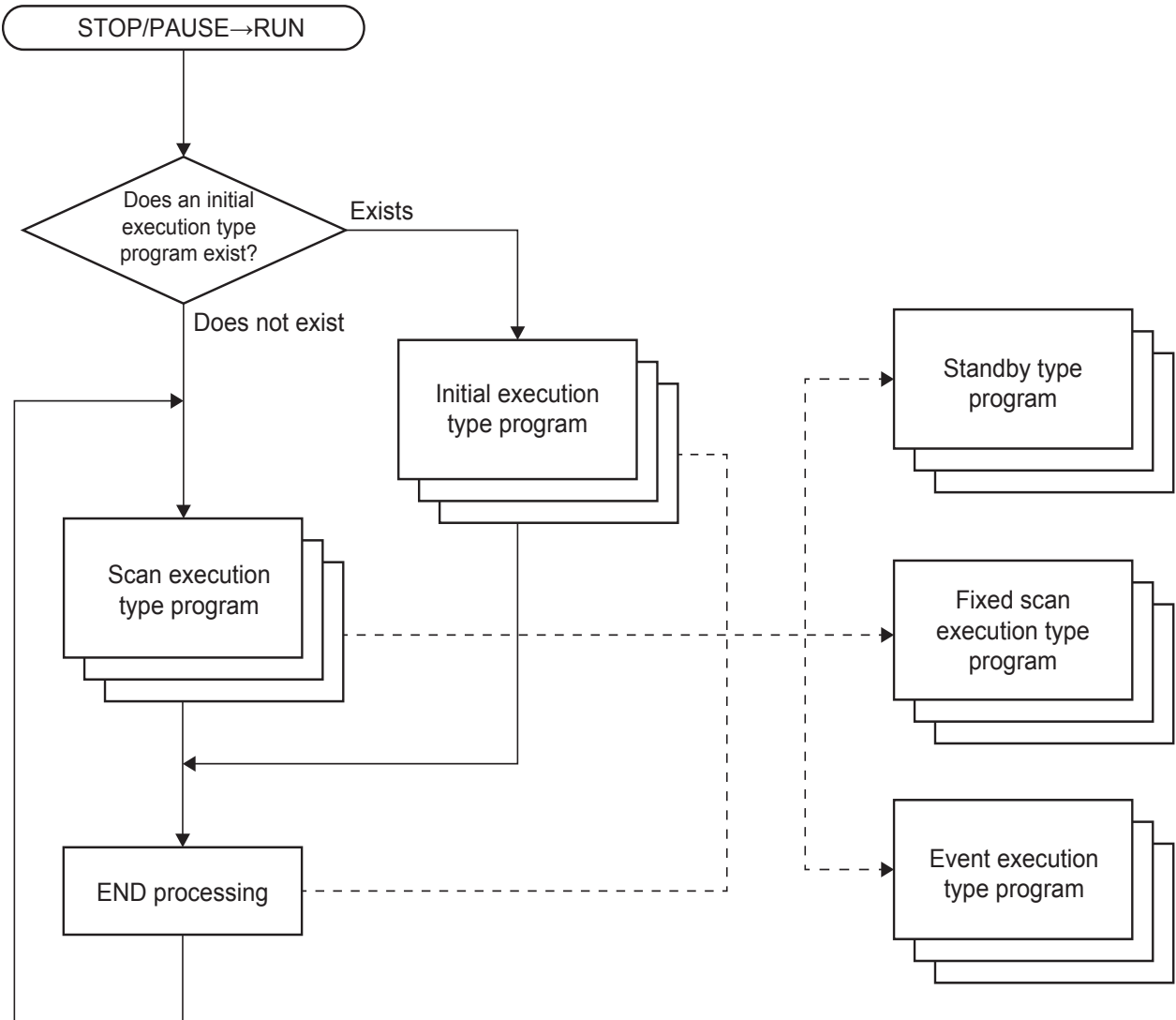

Point

When the execution type of the programs is the same, the programs are executed in the order in which the execution order was set.

1.4 Execution Type of Program

Set the program execution conditions.

Initial execution type program

This program type is executed only once when the CPU module changes from the STOP/PAUSE to the RUN status. This program type is used for programs, that do not need to be executed from the next scan once they are executed, like initial processing on an intelligent function module.

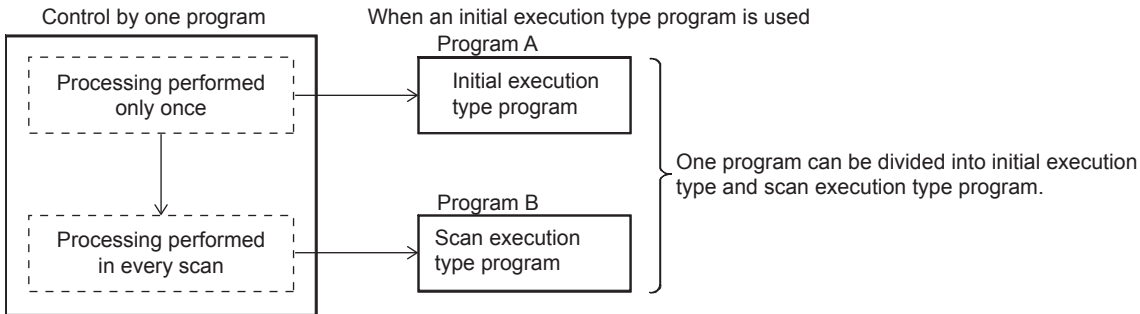

Also, the execution time of initial execution type programs is the same as the initial scan time.

When multiple initial execution type programs are executed, the execution time of the initial execution type programs becomes the time until execution of all initial execution type programs is completed.

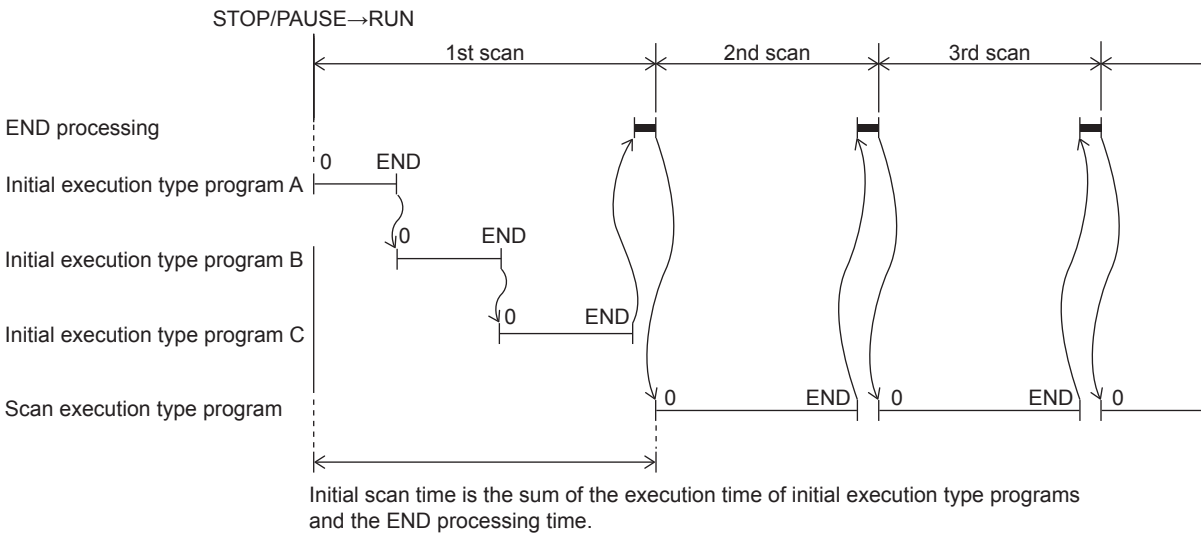

Precautions

The precautions for initial execution type programs are explained below.

■Restrictions in programming

With initial execution type programs, do not use instructions that require several scans to complete execution (instructions for which completion devices exist).

Ex.

e.g. RBFM and WBFM instructions

Scan execution type program

This program type is executed only once per scan from the scan following the scan where an initial execution type program was executed.

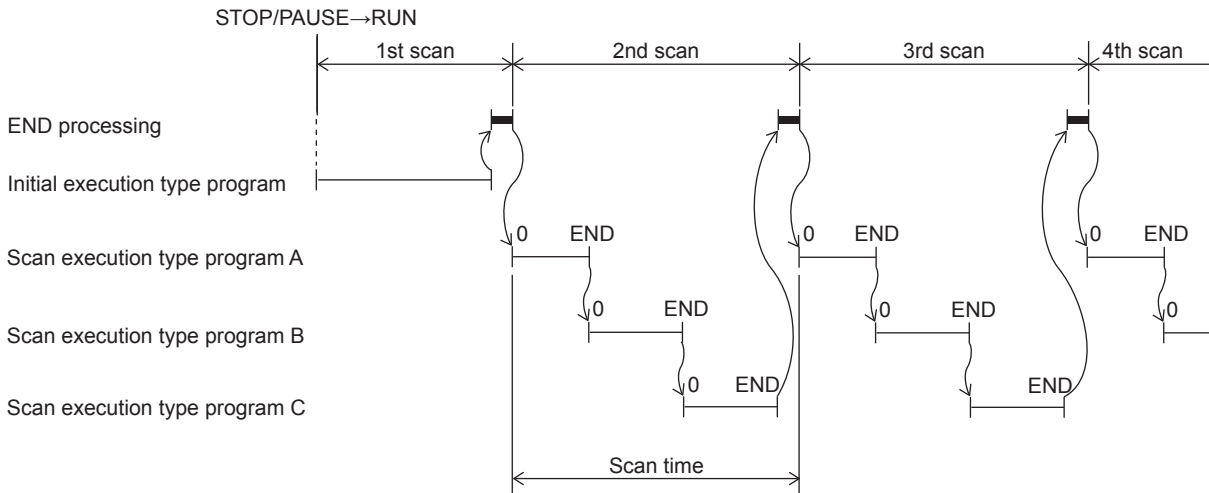

When multiple scan execution type programs are executed, the execution time of the scan execution type programs becomes the time until execution of all scan execution type programs is completed. Note, however, that when an program/event execution type program is executed before a scan execution type program is completed, the execution time of these programs is included in the scan time.

Point

- For the SFC program, only the scan execution type program can be specified.
- For SM402 (After RUN, ON for one scan only) and SM8002 (Initial pulse NO contact) in the scan execution type program, the action differs depending on the following.
 - When there is not an initial execution type program: SM402 and SM8002 are executed.
 - When there is an initial execution type program: SM402 and SM8002 are not executed.

Fixed scan execution type program

An interrupt program which is executed at a specified time interval. Different from the normal interrupt program, this type of program does not require interrupt pointer (I) and IRET instruction to be written (pointer is assigned by parameter). Execution is performed by program file basis.

You can use 4 files of fixed scan execution type programs at the maximum.

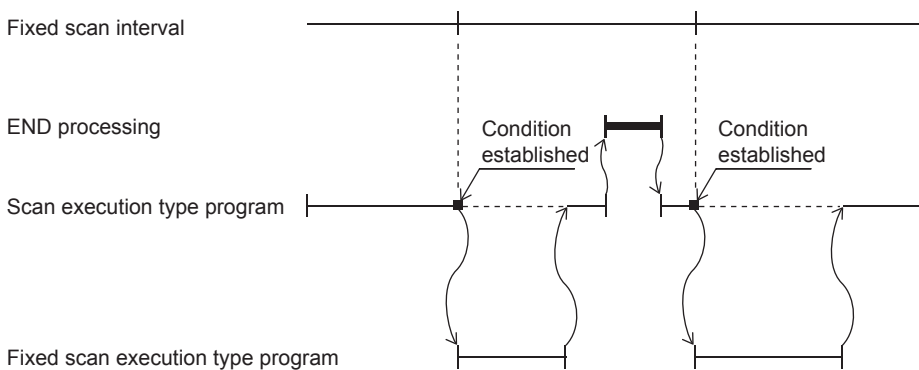

Point

To execute a fixed scan execution type program, the EI instruction must be used to enable interrupts.

Make the following settings for fixed scan execution type program in CPU parameter.

- Interrupt pointer setting (Interrupt from internal timer: I28 to I31)
- Fixed scan interval setting

Interrupt pointer setting

The interrupt pointer (Interrupt from internal timer: I28 to I31) assigned to a fixed scan execution type program is set up.

Navigation window ⇒ [Parameter] ⇒ [FX5UJCPU] or [FX5UCPU] ⇒ [CPU Parameter] ⇒ "Program Setting" ⇒ "Program Setting" ⇒ "Detailed Setting" ⇒ "Detailed Setting Information"

1. Open program setting screen.
2. Set type as fixed scan.
3. Specify interrupt pointer.

Window

Execute Order	Program Name	Execution Type	
		Type	Detailed Setting Information
1	MAIN	Scan	
2	MAIN1	Fixed Scan	Interrupt:I31:10 ms
3			
4			
5			

Displayed items

Item	Description	Setting range	Default
Interrupt Pointer	Set the interrupt pointer which is assigned to fixed scan execution type program.	<ul style="list-style-type: none"> • I28 • I29 • I30 • I31 	I31
Specified Time Intervals	Fixed scan interval setting value is displayed. Setup is performed on another screen. (Page 24 Fixed scan interval setting)	—	—

Fixed scan interval setting

Sets the fixed scan interval setting of the fixed scan execution type program. (It is the same as setting for interrupt from internal timer.)

Navigation window ⇒ [Parameter] ⇒ [FX5UJCPU] or [FX5UCPU] ⇒ [CPU Parameter] ⇒ "Interrupt Settings" ⇒ "Fixed Scan Interval Setting"

Window

Item	Setting
Fixed Scan Interval Setting	
Interrupt Setting from Internal Timer	
I28	100 ms
I29	40 ms
I30	20 ms
I31	10 ms

Displayed items

Item	Description	Setting range	Default
Interrupt Setting from Internal Timer	I28	Sets the execution interval of I28.	1 to 60000 ms (1 ms units)
	I29	Sets the execution interval of I29.	1 to 60000 ms (1 ms units)
	I30	Sets the execution interval of I30.	1 to 60000 ms (1 ms units)
	I31	Sets the execution interval of I31.	1 to 60000 ms (1 ms units)
			100 ms
			40 ms
			20 ms
			10 ms

Action when the execution condition is satisfied

Performs the following action.

■If the execution condition is satisfied before the interrupt is enabled by the EI instruction

The program enters the waiting status and is executed when the interrupt is enabled. Note that if the execution condition for this fixed scan execution type program is satisfied more than once during the waiting status, the program is executed only once when the interrupt is enabled.

■When there are two or more fixed scan execution type programs

When the specified time intervals expire in the same timing, the programs are executed in order according to the priority (I31 > I30 > I29 > I28) of the periodic interrupt pointer.

■If another or the same execution condition is satisfied while the fixed scan execution type program is being executed

Operates according to the fixed scan execution mode setting.

■If the execution condition is satisfied while the interrupt is disabled by the system

Operates according to the fixed scan execution mode setting.

■If an interrupt factor occurs during link refresh

Suspends link refresh and executes the fixed scan execution type program. Even while station unit block guarantee is enabled for cyclic data during refresh of such links as CC-Link IE field network, if the fixed scan execution type program uses a device specified as the refresh target, station unit block guarantee for cyclic data is not available.

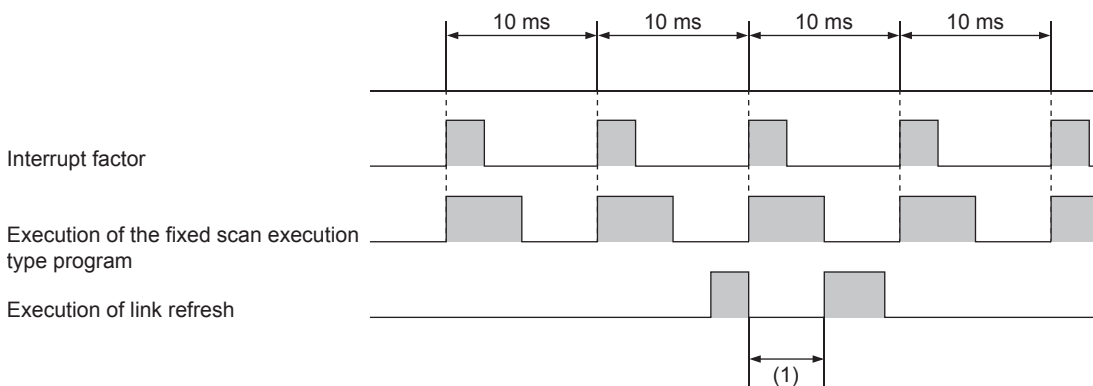

(1) Suspends link refresh and executes the fixed scan execution type program.

■When an interrupt is generated during a standby while executing constant scan

Executes the fixed scan execution type program.

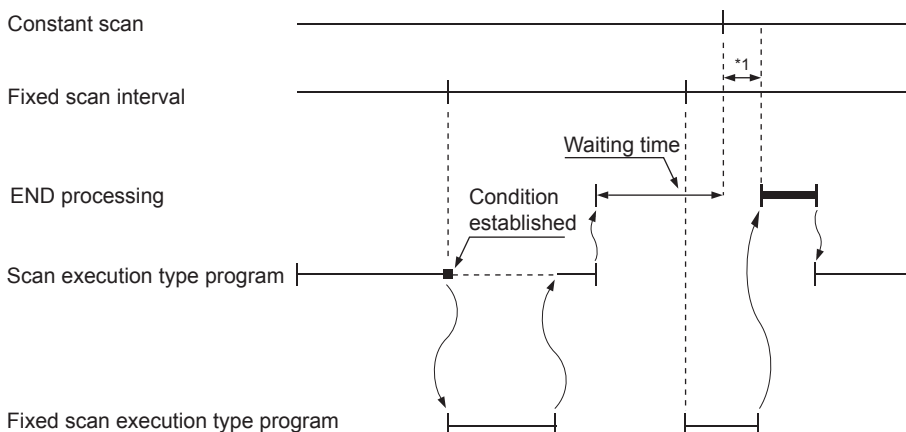

*1 If processing does not finish during the waiting time, the scan time is extended.

■If another interrupt occurs while the fixed scan execution type program is being executed

If an interrupt program is triggered while the fixed scan execution type program is being executed, the program operates in accordance with the interrupt priority.

Processing when the fixed scan execution type program starts

The same processing as when the interrupt program starts. (Page 38 Processing at startup of interrupt program)

Fixed scan execution mode

If execution condition for a fixed scan execution type program and fixed cycle interrupt (I28 to I31) based on the internal timer of the CPU module is satisfied while interruption is disabled, the operation of the program execution after interruption becomes allowed is specified. However, if execution condition is satisfied while interruption is set to be disabled because of a DI instruction or the like, this is out of the scope of the fixed scan execution mode.

Point

"Interrupts disabled" refers to the following:

- A program having an interrupt priority higher than or the same as the corresponding program is currently being executed.
- The corresponding program is currently being executed.
- Program execution is currently at a part in which interrupts are disabled by the system.

Operation in the fixed scan execution mode

This section describes the operation which can be performed in the fixed scan execution mode.

• Execution Count Takes Priority

The program is executed for all the pending number of executions so that it can be executed the same number of times as execution condition was satisfied.

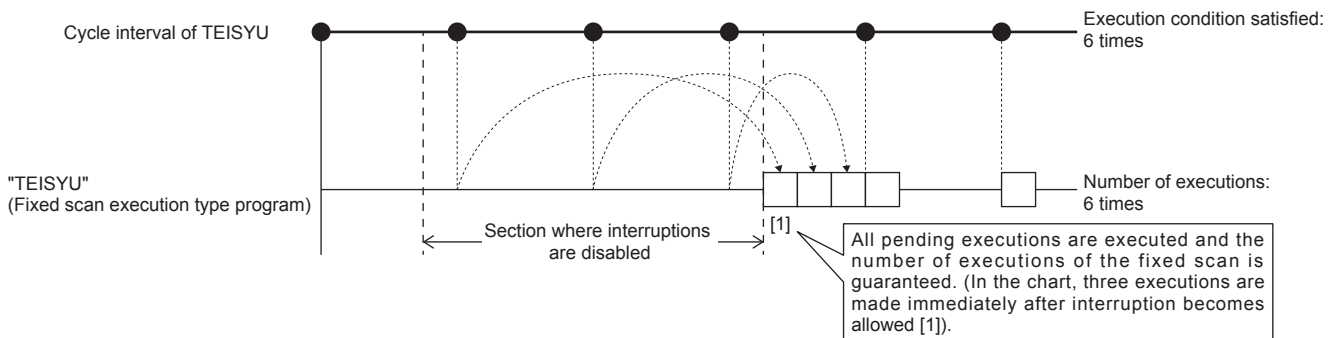

• Precede Fixed Scan

When the waiting for execution, one execution is made when interrupt becomes allowed. Even if execution condition was satisfied twice or more, only one execution is performed.

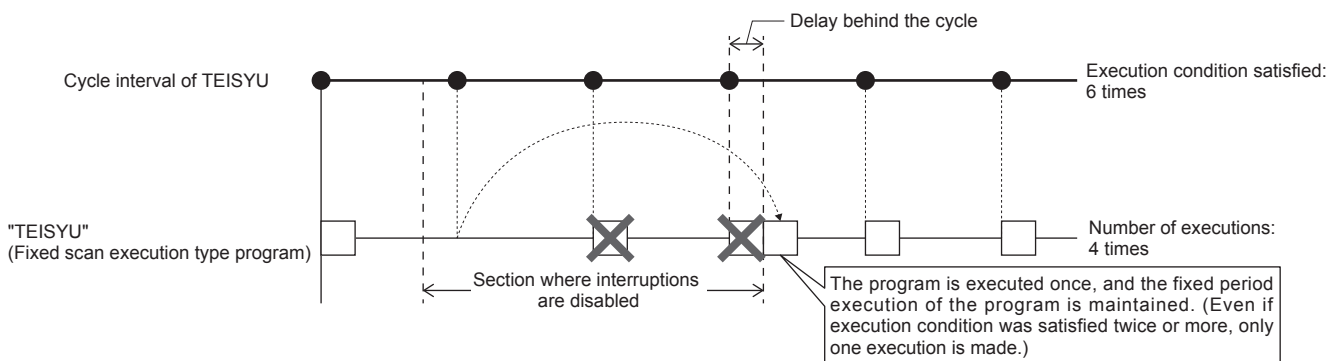

■ Fixed scan execution mode setting

Use the fixed scan execution mode setting.

Navigation window ⇒ [Parameter] ⇒ [FX5UJCPU] or [FX5UCPU] ⇒ [CPU Parameter] ⇒ "Interrupt Settings" ⇒ "Fixed Scan Execution Mode Setting"

Window

Item	Setting
Fixed Scan Execution Mode Setting	
Fixed Scan Execution Mode	Precede Fixed Scan

Displayed items

Item	Description	Setting range	Default
Fixed Scan Execution Mode	For Precede Fixed Scan, the periodicity of the program is maintained. For Execution Count Takes Priority, the program is executed for all pending number of executions.	<ul style="list-style-type: none"> Precede Fixed Scan Execution Count Takes Priority 	Precede Fixed Scan

Event execution type program

Execution of this program type is triggered by a user-specified event. (☞ Page 28 Trigger type)

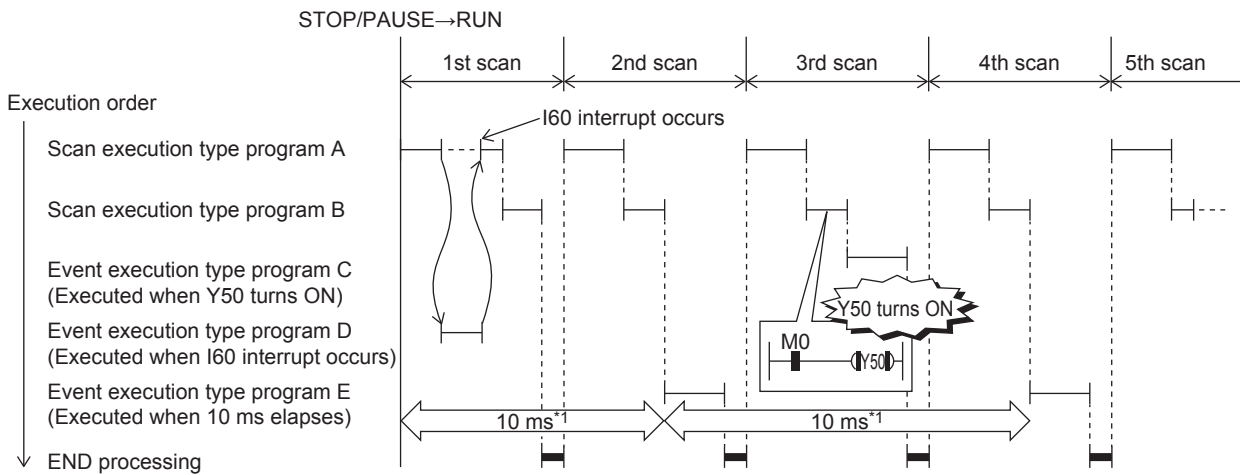

*1 Measurement of elapsed time is 10 ms or more because it is determined depending on the scan time.

Trigger type

Triggers for event execution type programs are explained below. (☞ Page 30 Trigger setting)

■ Generation of interrupt by interrupt pointer (I)

The program is executed once, immediately, when a specified interrupt cause is generated. An interrupt pointer label can be appended by adding the FEND instruction to a different program, and the program description partitioned by the IRET instruction can be turned into an exclusive program.

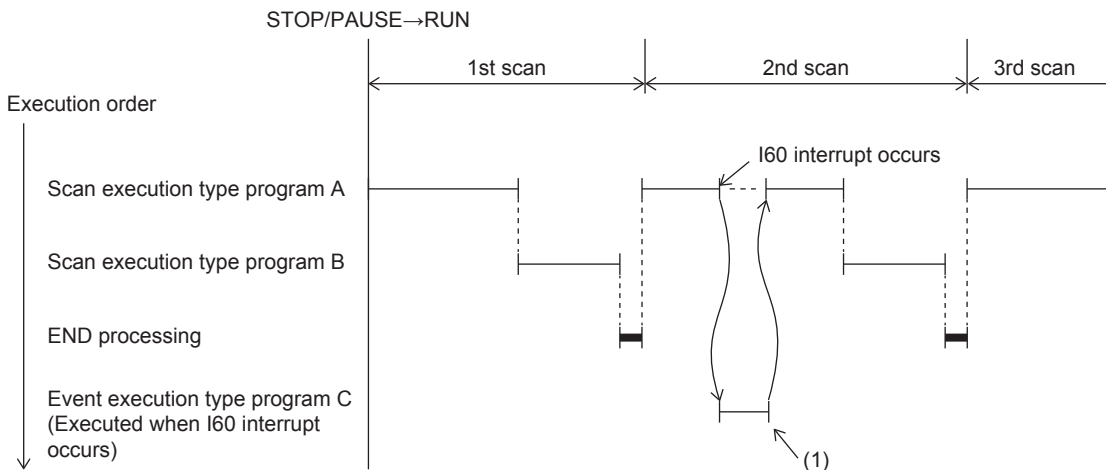

(1) Event execution type program C is executed immediately when the specified event is generated.

• Specifiable interrupt pointer (I)

Specifiable interrupt pointers are I0 to I15, I16 to I23, and I50 to I177.

Point

Execution conditions for the event execution type program which is triggered by interrupt occurred by the interrupt pointer (I) are the same as those for general interrupt programs. (☞ Page 34 Operation when an interrupt is generated)

■Bit data ON (TRUE)

When it is the turn of the corresponding program to be executed, the program is executed if the specified bit data is ON. This eliminates the need for creating a program for monitoring triggers in a separate program. After the specified bit data changes from ON (TRUE) to OFF (FALSE) and it is the turn of the corresponding event execution type program to be executed, output (Y) currently used in the corresponding program and the current values of timer (T) can be cleared.

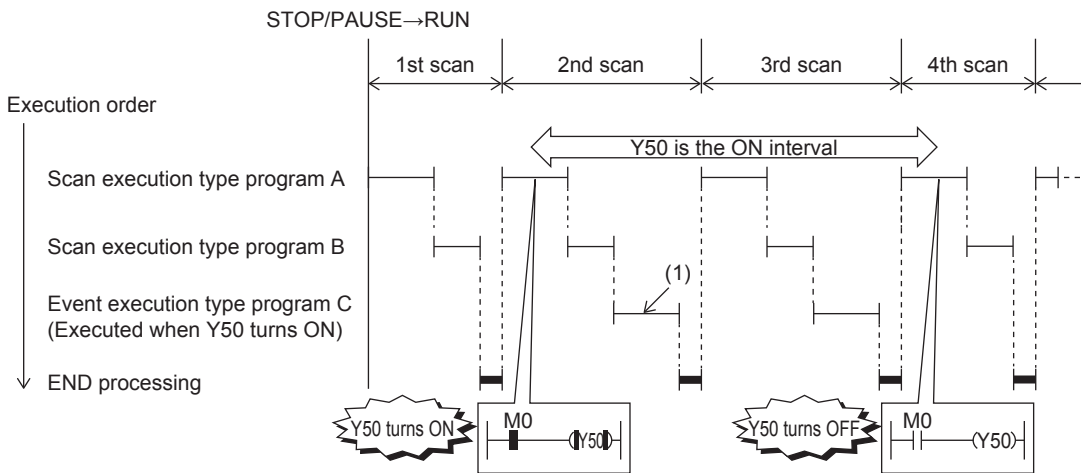

(1) The program is executed if Y50 is ON when it is the turn of event execution type program C to be executed.

Applicable devices are as follows.

Item	Description	
Device*1	Bit device	X (DX), Y, M, L, F, SM, B, SB
	Bit specification in word device	D, SD, W, SW, R, U□\G□

*1 Indexed devices cannot be specified.

■Elapsed time

The program is executed once when it is the turn of the corresponding program to be executed first after the CPU module is run and the specified time has elapsed. For second execution onwards, the time is re-calculated from the start of the previous event execution type program. When it is the turn of the corresponding program to be executed first after specified time has elapsed, program execution is repeated. Output (Y) currently used in the corresponding program and the current values of timer (T) can be cleared at the next scan following execution of the corresponding program. This will not be always executing an interrupt at a constant cycle but can be used when executing a specified program after a specified time has elapsed.

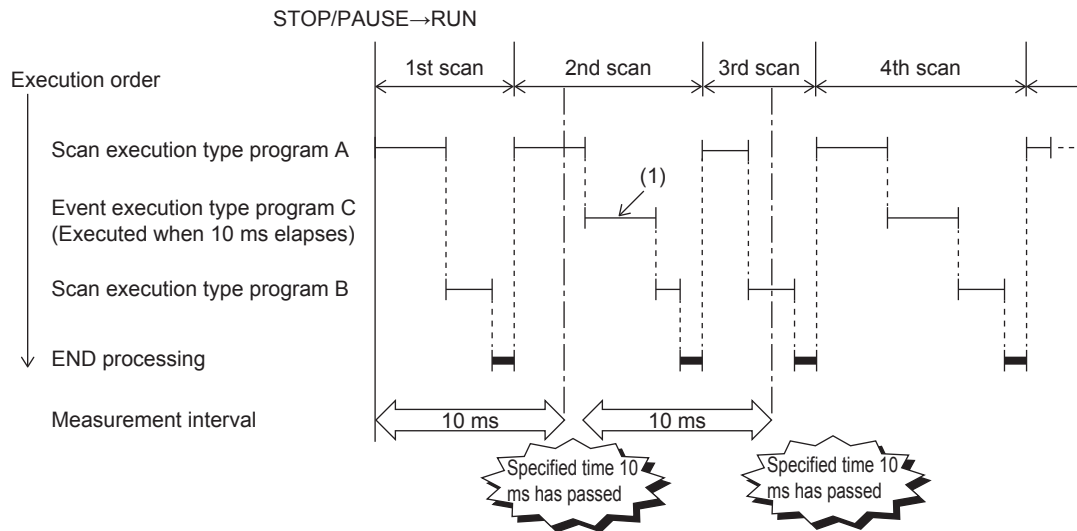

(1) When it is the turn of the first execution after the specified time has elapsed, event execution type program C is executed.

Point

Output and timer current values are not cleared even when the program is set so that output and timer current values are cleared, if the scan time is longer than the elapsed time set value.

Trigger setting

Use the event execution type detail setting.

Navigation window ⇒ [Parameter] ⇒ [FX5UJCPU] or [FX5UCPU] ⇒ [CPU Parameter] ⇒ "Program Setting"

Operating procedure

"Program Setting" window

Item	Setting
Program Setting	<Detailed Setting>

"Detailed Setting" window

Execute Order	Program Name	Execution Type	
		Type	Detailed Setting Information
1	MAIN	Event	Bit ON/Do Not Clear
2			

"Event Execution Type Detailed Setting" window

Item	Setting
Trigger Type	ON of Bit Data (TRUE)
Interruption Occurrence	
ON of Bit Data (TRUE)	
Clear Output and Current Value of Timer	Do Not Clear
Passing Time	
Unit	ms
Clear Output and Current Value of Timer	Do Not Clear

1. Click "Detailed Setting" on the Program Setting.
2. Select the program name and set the execution type to "Event".
3. Click "Detailed Setting Information".
4. Set the trigger type to execute the event execution type program.

Displayed items

Item		Description	Setting range	Default
Interruption Occurrence		Sets the interrupt pointer used as the trigger.	I0 to I23, I50 to I177	—
ON of Bit Data (TRUE)		Sets the device used as the trigger.	☞ Page 29 Bit data ON (TRUE)	—
Clear Output and Current Value of Timer		Sets that the current values of the output (Y), and timer (T) used in this program are cleared at the execution turn of the event execution type program that comes after the specified bit data is OFF.	<ul style="list-style-type: none"> Do Not Clear Clear 	Do Not Clear
Passing Time	Unit	Sets the time passed.	<ul style="list-style-type: none"> When "ms" is selected: 1 to 65535 ms (in units of 1 ms) When "s" is selected: 1 to 65535 s (in units of 1 s) 	—
	Clear Output and Current Value of Timer	Sets that the current values of the output (Y), and timer (T) used in this program are cleared at the execution turn of the event execution type program that comes after the specified time passes.	<ul style="list-style-type: none"> Do Not Clear Clear 	—

Point

When "Clear Output and Current Value of Timer" is enabled together with "ON of Bit Data (TRUE)" or "Passing Time", the current values of the output (Y) and timer (T) of this program can be cleared at the first execution turn of this program that comes after the trigger turns OFF.

Stand-by type program

This program is executed only when there is an execution request.

Saving programs in library

Subroutine programs or interrupt programs are saved as standby type programs so that they can be used when controlled separately from the main routine program. Multiple subroutine programs and interrupt programs can be created in one standby type program.

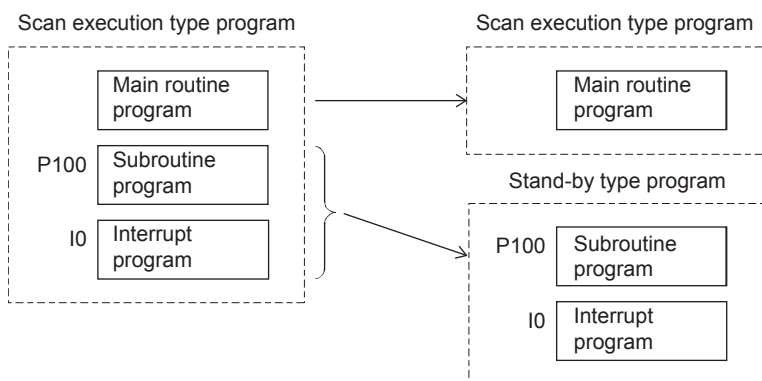

How to execute

Execute standby type programs as follows.

- Create sub-routine programs and interrupt programs in the standby type program which is called up by a pointer, etc. or when an interrupt is generated.

1.5 Program Type

Programs that use pointers (P) or interrupt pointers (I) are explained below.

Subroutine program

This is the program from pointer (P) up to the RET instruction. Subroutine programs are executed only when they are called by the CALL instruction. Pointer type labels also can be used instead of pointers (P). The applications of subroutine programs are as follows:

- By grouping programs that are executed multiple times in one scan into a single subroutine program, the number of steps in the entire program can be reduced.
- A program that is executed only under certain conditions can be saved as a subroutine program which shortens the scan time proportionately.

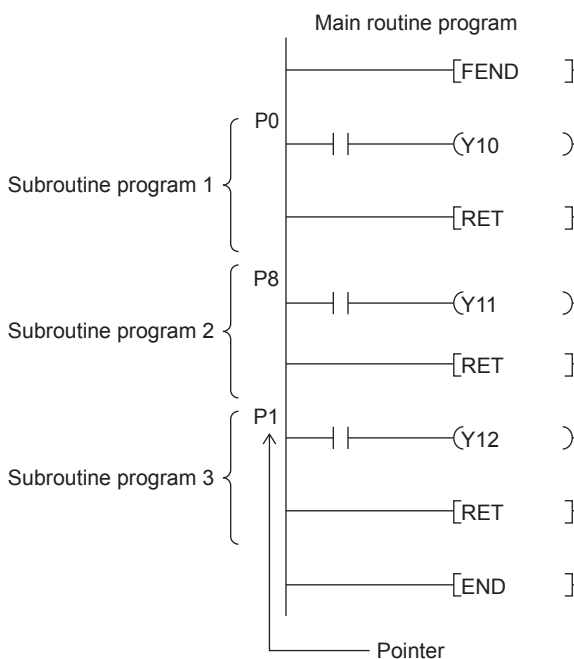

Point

- Subroutine programs can also be managed as separate programs by turning them into standby type programs. (☞ Page 31 Stand-by type program)
- Pointers need not be programmed starting with the smallest number.

Precautions

The precautions when using subroutine programs are explained below.

- Do not use timers (T, ST). Note, however, that timers can be used when a timer coil (OUT T□ instruction) is always executed only once in one scan.
- An error occurs when program execution returns to the call source program and the program is terminated without using the RET instruction.
- An error occurs when there is no pointer (P) or pointer type global label in FB or FUN.
- When the CALL instruction is used in the operation output of the step of the SFC program, even though the transition condition is established and the step is deactivated, the output of the call destination is not turned OFF. When turning OFF the output of the call destination, use the XCALL instruction.

Interrupt program

This is the program from interrupt pointer (I) up to the IRET instruction.

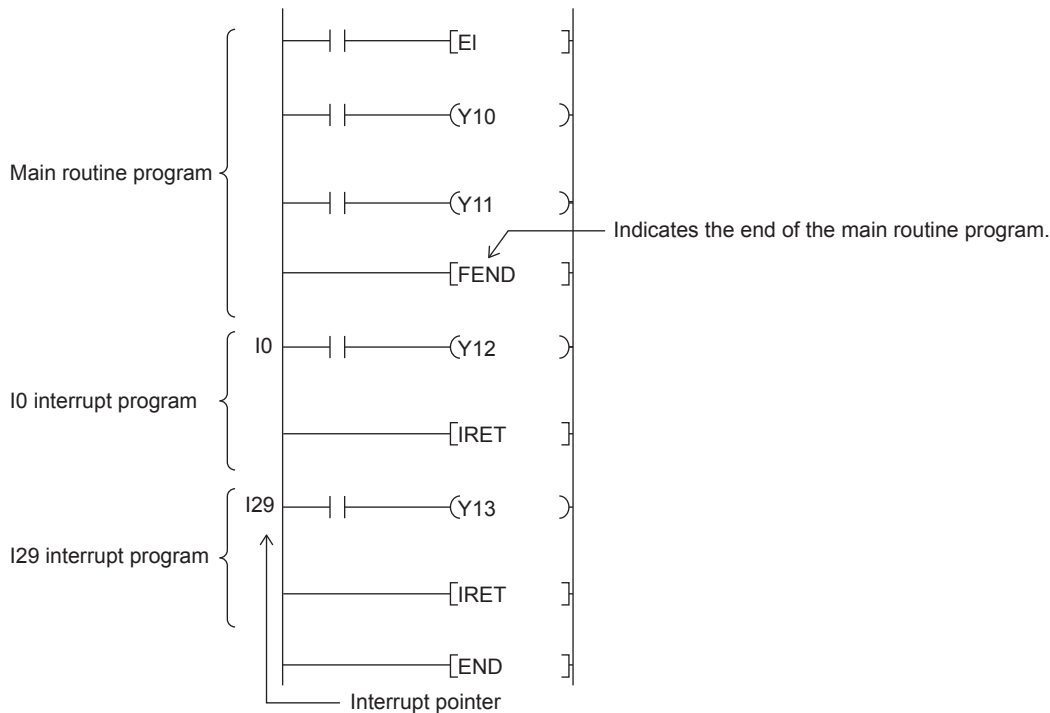

When an interrupt is generated, the interrupt program corresponding to that interrupt pointer number is executed. Note, however, that interrupt enabled status must be set with the EI instruction before executing the interrupt program.

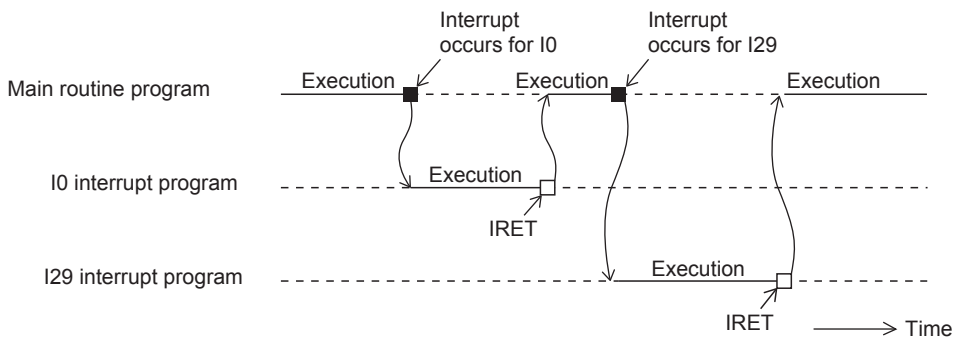

Point

- Only one interrupt program can be created with one interrupt pointer number.
- Interrupt pointers need not be programmed starting with the smallest number.
- Interrupt programs can also be managed as separate programs by turning them into standby type programs. (☞ Page 31 Stand-by type program)

Operation when an interrupt is generated

Operation when an interrupt is generated is explained below.

■If an interrupt cause occurs when interrupt is disabled (DI)

The interrupt that was generated is stored, and the stored interrupt program is executed the moment that the status changes to interrupt enabled. An interrupt is stored only once even if the same interrupt is generated multiple times. Note, however, that all interrupts cause are discarded when interrupt disable is specified by the IMASK and SIMASK instructions.

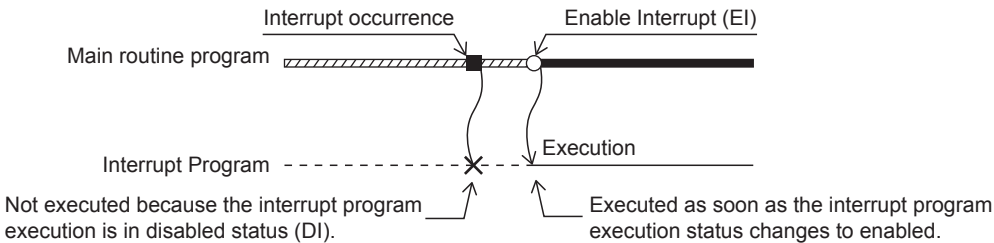

■When an interrupt cause is generated by a PAUSE status

The interrupt program is executed the moment that the CPU module changes to the RUN status and the status changes to interrupt enabled. An interrupt is stored only once when the same interrupt is generated multiple times before the CPU module changes to the RUN status.

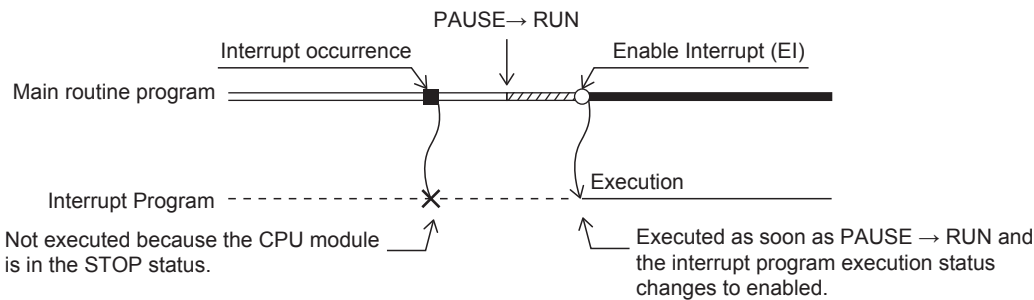

■If an interrupt factor occurs during link refresh

Suspends link refresh and executes the interrupt program. Even though station unit block guarantee is enabled for cyclic data during refresh of such links as CC-Link IE Field Network, if the interrupt program uses a device specified as the refresh target, station unit block guarantee for cyclic data is not available.

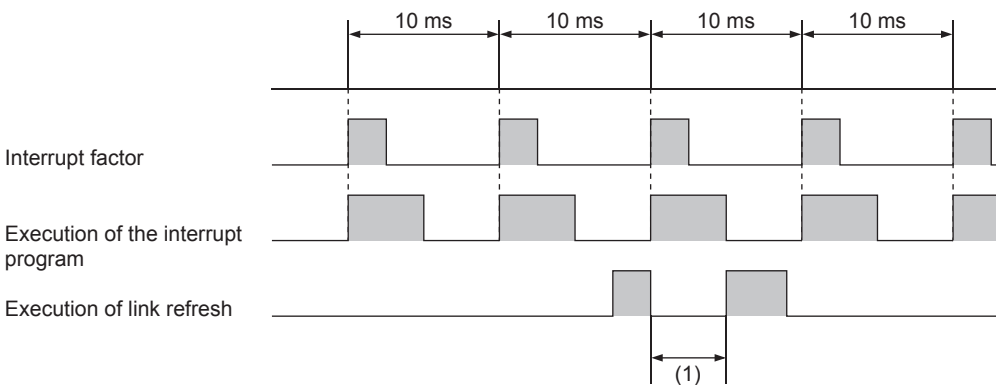

(1) Suspends link refresh and executes the interrupt program.

■When multiple interrupts are generated at the same time while in an interrupt enabled status

Interrupt programs are executed in order starting from program having the highest priority. Interrupt programs also run in order of priority rank when multiple interrupt programs having the same priority are generated simultaneously.

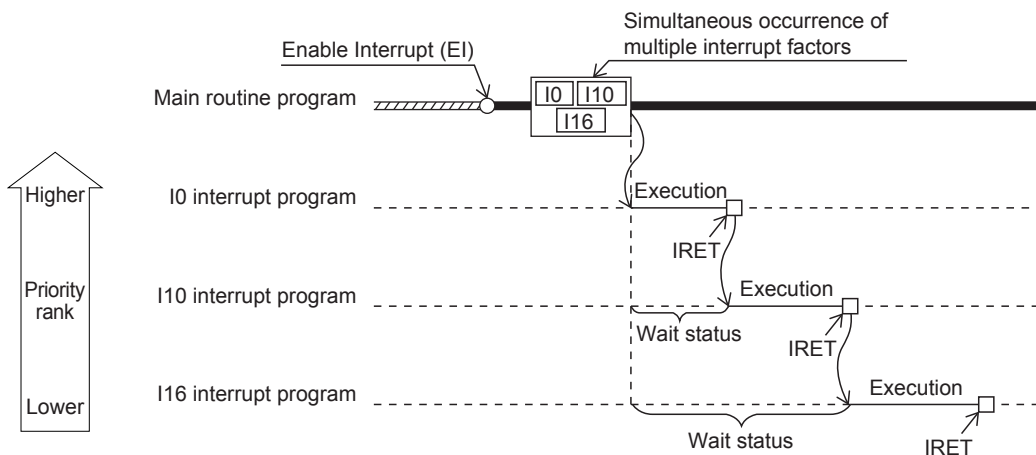

■When an interrupt is generated during standby while executing constant scan

The interrupt program for that interrupt is executed.

■When another interrupt is generated during execution of the interrupt program

If an interrupt such as a fixed scan execution type program (including an interrupt which triggers the event execution type program) is triggered while an interrupt program is being executed, the program operates in accordance with the interrupt priority.

■ If an interrupt cause with the same or a lower priority occurs while the interrupt program is being executed

- For I0 to I23 and I50 to I177

The occurred interrupt cause is memorized, and the interrupt program corresponding to the factor will be executed after the running interrupt program finishes. Even if the same interrupt factor occurs multiple times, it will be memorized only once.

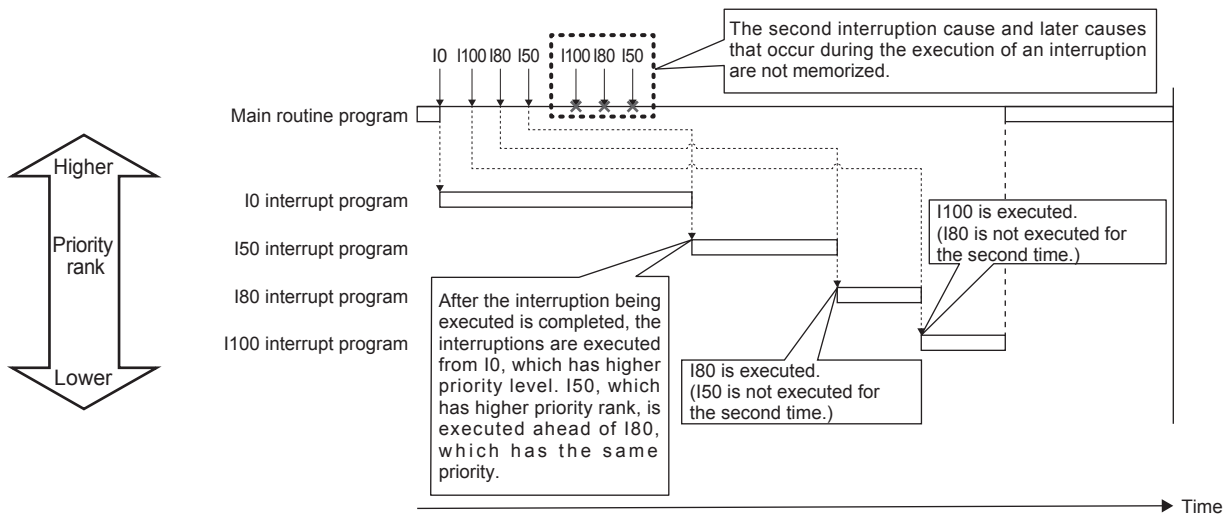

- For I28 to I31

The interrupt cause that occurred is memorized, and the interrupt program corresponding to the cause will be executed after the running interrupt program finishes. If the same interrupt cause occurs multiple times, it will be memorized once but operation at the second and later occurrences depends on setting of the fixed scan execution mode. (Page 26 Fixed scan execution mode)

When "Execution Count Takes Priority" is enabled, the interrupt program corresponding to the memorized interrupt causes will be executed after the running interrupt program finishes. When "Precede Fixed Scan" is enabled, the second and later occurrences will not be memorized.

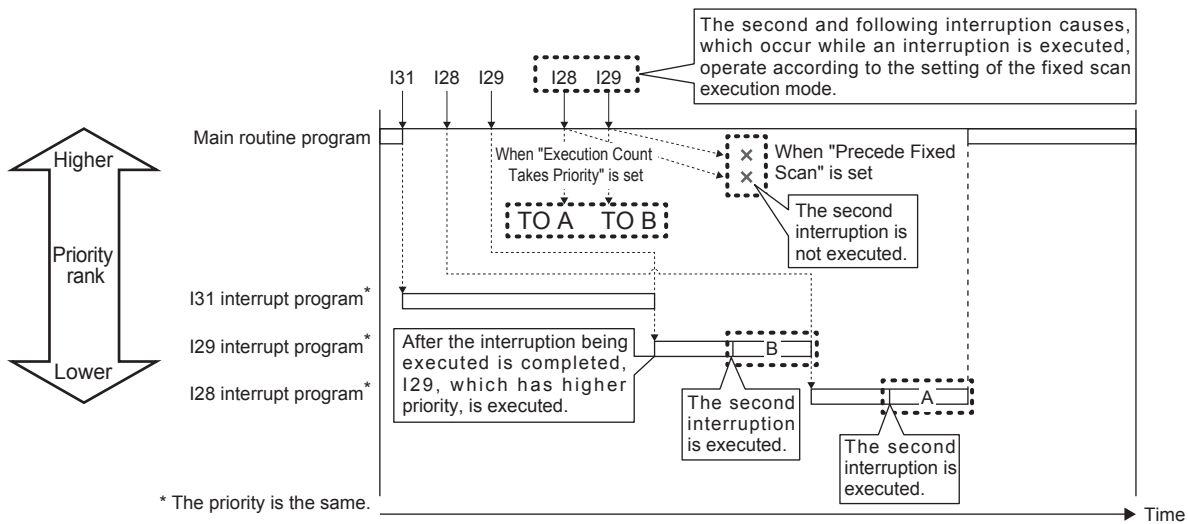

■ If the same interrupt cause occurs while the interrupt program is being executed

- For I0 to I23 and I50 to I177

The interrupt cause that occurred is memorized, and the interrupt program corresponding to the cause will be executed after the running interrupt program finishes. Even if the same interrupt cause occurs multiple times, it will be memorized only once.

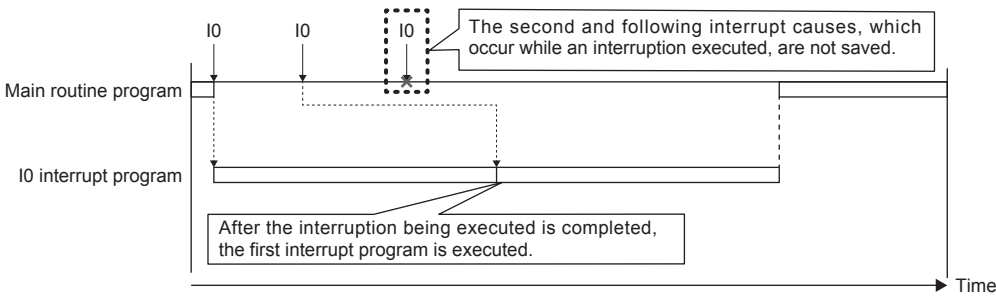

- For I28 to I31

The interrupt cause is memorized, and the interrupt program corresponding to the cause will be executed after the running interrupt program finishes. If the same interrupt factor occurs multiple times, it will be memorized once but operation at the second and later occurrences depends on setting of the fixed scan execution mode. (Page 26 Fixed scan execution mode)

When "Execution Count Takes Priority" is enabled, the interrupt program corresponding to the memorized interrupt cause will be executed after the running interrupt program finishes. When "Precede Fixed Scan" is enabled, the second and later occurrences will not be memorized.

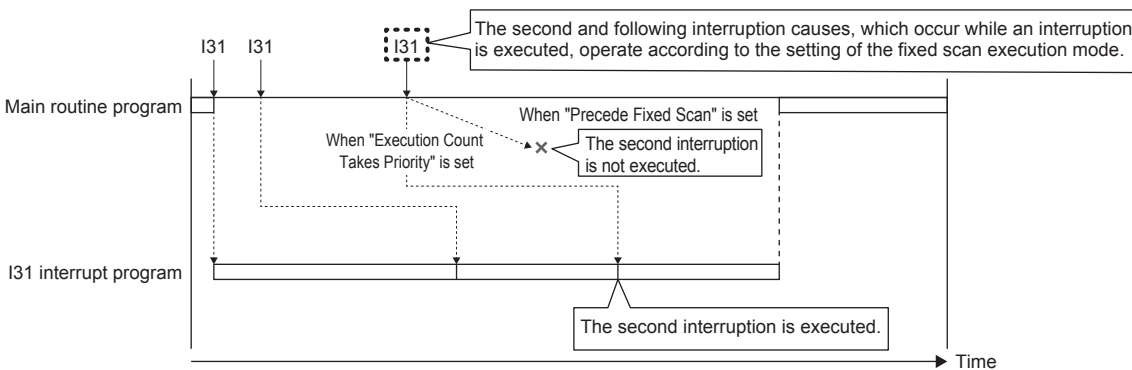

Setting the interrupt cycle

Set the interrupt cycle of interrupts I28 to I31 using the internal timer of the interrupt pointer.

Navigation window ⇒ [Parameter] ⇒ [FX5UJCPU] or [FX5UCPU] ⇒ [CPU Parameter] ⇒ "Interrupt Settings" ⇒ "Fixed Scan Interval Setting"

Window

Item	Setting
Fixed Scan Interval Setting	
Interrupt Setting from Internal Timer	
I28	100 ms
I29	40 ms
I30	20 ms
I31	10 ms

Displayed items

Item	Description	Setting range	Default	
Interrupt Setting from Internal Timer	I28	Sets the execution interval of I28.	1 to 60000 ms (1 ms units)	100 ms
	I29	Sets the execution interval of I29.	1 to 60000 ms (1 ms units)	40 ms
	I30	Sets the execution interval of I30.	1 to 60000 ms (1 ms units)	20 ms
	I31	Sets the execution interval of I31.	1 to 60000 ms (1 ms units)	10 ms

Processing at startup of interrupt program

Processing is as follows when an interrupt program is started up.

- Purge/restore of index registers (Z, LZ)

■Purge/restore of index registers (Z, LZ)

When an interrupt program is started up, the values of the index registers (Z, LZ) in the currently executing program are purged, and those values are handed over to the interrupt program. Then, when an interrupt program is terminated, the purged values are restored to the currently executing program.

Precautions

The precautions for interrupt programs are explained below.

■Restrictions in programming

- The PLS/PLF instructions execute OFF processing at the scan following instruction execution. ON devices remain ON until the interrupt program runs again and the instruction is executed.
- Only a routine timer can be used in an interrupt program. Timers (T, ST) cannot be used.

■Splitting of data

Processing may be interrupted during instruction execution and an interrupt programs can be executed. Accordingly, splitting of data might occur if the same devices are used by both the interrupt program and the program that is aborted by the interrupt. Implement the following preventive measure.

- Set instructions that will result in inconsistencies if interrupted to "interrupt disabled" using the DI instruction.
- When using bit data, ensure that the same bit data is not used by both the interrupt program and the program that is aborted by the interrupt.

■Interrupt precision is not improved

If interrupt precision is not improved, this might be remedied by implementing the following:

- Give higher priority to the interrupt that needs higher precision.
- Use an interrupt pointer with high interrupt priority order.
- Recheck the section of interruption disabled.

2 PROCESSING OF OPERATIONS ACCORDING TO CPU MODULE OPERATION STATUS

The CPU module has three operation statuses as follows:

- RUN status
- STOP status
- Paused

Processing of operations on the CPU module in each status is explained below.

Processing of operations in RUN status

In the RUN mode, operations in the sequence program are executed repeatedly in order step 0→END (FEND) instruction→step 0.

■Output when CPU module enters RUN mode

Operation results are output after the sequence program is executed for the duration of one scan.

The device memory other than the output (Y) holds the state immediately before the RUN state. However, if device initial value is set up, this initial value is set.

■Processing time until start of operation

The processing time from the CPU module switching from STOP→RUN up to start of execution of operations in the sequence program fluctuates according to the system configuration and parameter settings. (Normally, this time is within one second.)

Processing of operations in STOP status

In the STOP status, execution of operations in the sequence program is stopped by the RUN/STOP/RESET switch or a remote stop. The CPU module also enters the STOP status when a stop error occurs.

■Output when CPU module enters STOP status

When the CPU module enters the STOP status, all output points (Y) turn OFF. For device memory other than outputs (Y), non-latch devices are cleared and latch devices are held.

However, when SM8033 is on and CPU module switches RUN→STOP, it is possible to hold an output state and the current value of a device.

Precautions

When SM8033 is ON, PC write with an engineering tool cannot be performed.

Processing of operations in paused status

In a paused status, execution of operations in the sequence program is stopped after one scan execution but with outputs and device memory states held, by a remote pause.

Processing of operations by the CPU module during switch operations

Processing of operations by the CPU module is as follows according to the RUN or STOP mode.

RUN/STOP status	Processing of operations by CPU module			
	Processing of operations in sequence program	External output	Device memory	
			Other than Y	Y
RUN→STOP	The program is executed up to the END instruction and then stops.	All output points turn OFF.	Latch devices are held, and non-latch devices are cleared.	All output points turn OFF.
STOP→RUN	Program execution starts from step 0.	Operation results are output after the PLC is run for the duration of one scan.	The states of device memories immediately before the CPU module entered the RUN mode are held. Note, however, that when device initial values are set, the device initial values are set.	Operation results are output after the PLC is run for the duration of one scan.

Point

The CPU module performs the following processing regardless of RUN or STOP status or paused status.

- Refreshing of input/output modules
- Automatic refreshing of intelligent function modules
- Self-diagnostic processing
- Device/label access service processing
- Setting of values to special relays/special registers (set timing: when END processing is executed)

For this reason, the following operations can be performed even in the STOP status or paused status:

- Monitoring of I/O or test operations by the engineering tool
- Reading/writing from external device using SLMP
- N:N Network
- MODBUS RTU slave

3 CPU MODULE MEMORY CONFIGURATION

3.1 Memory Configuration

CPU module memory is explained below.

Memory configuration

The configuration of CPU module memory is explained below.

Memory type		Application
CPU built-in memory	Data memory	The following files are stored in this memory: <ul style="list-style-type: none"> • Program files, FB files • Restored information files • Parameter files • Files that contain device comments, etc.
	Device/label memory	Data areas for internal devices/labels, etc. are located in this memory.
	Signal flow memory	This memory is used to memorize the execution status of the instruction in the last scan.
	Temporary area	This memory is used temporarily by the system during the scan process. It is used as the label defined by the function or the instruction operand added by the system.
SD memory card		This is for storing files that contain device comments, etc. and folders and files that are created by SD memory card functions.

Data memory

The following files are stored in data memory.

Category	File type	Max. number of files	Storage area size	Remarks
Program	Program file	32	1 Mbytes	—
	FB files	16 (Up to 15 for user)		—
Restored information	Restored information files	48	1 Mbytes	—
Parameters	Parameter files common to system	1	1 Mbytes	—
	CPU parameter file	1		—
	Module parameter file	1		—
	Module extension parameter	18		—
	Remote password	1		—
	Device data storage file	1		—
	Global label setting file	1		—
	Data logging setting file	4		—
	Memory dump setting file	1		—
	Device initial values file	1		—
	Slave station parameter file ^{*1}	80 ^{*2}		—
Firmware update prohibited file	1	—		
Comments	Device comment file	1	2 Mbytes	—

*1 Only FX5U/FX5UC CPU module is supported.

*2 When the firmware version of the FX5U/FX5UC CPU module is "1.230" or earlier, the maximum number of the files is 60.

Device/label memory

Device/label memory has the following areas.

Area	Storage area size	Application
Device/label memory (standard)	63 K words	<ul style="list-style-type: none"> ■FX5UJ CPU module <ul style="list-style-type: none"> • R, W, SW, labels, and latch labels are fixed in the memory. ■FX5U/FX5UC CPU module <ul style="list-style-type: none"> • R, W, SW, labels, and latch labels can be placed in this memory in variable lengths. • R and W can be backed up in the event of a power interruption only when the optional battery is installed. Also, latch label capacity can be increased when the battery is installed.
Device/label memory (fast)	12 K words	<ul style="list-style-type: none"> ■FX5UJ CPU module <ul style="list-style-type: none"> • Bit devices, T, ST, C, LC, D, Z, and LZ are fixed in the memory. ■FX5U/FX5UC CPU module <ul style="list-style-type: none"> • Bit devices, T, ST, C, LC, D, Z, LZ, labels, and latch labels can be placed in this memory in variable lengths.

Signal flow memory

This memory is used to memorize the execution status of the instruction in the last scan. The CPU module judges whether to execute a rising/falling edge execution instruction by referring to the signal flow memory.

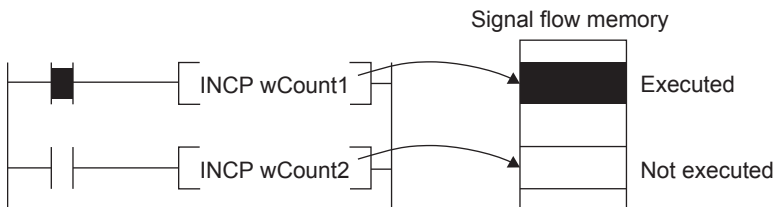

The execution status of the last instruction is stored in the signal flow memory in two ways: executed or not executed. The instructions that refer to the signal flow memory judge whether to execute a rising/falling edge execution instruction depending on the input condition of the instruction and the execution status of the last instruction stored in the signal flow memory.

- For a program, the same number of areas as steps of the program are assigned to the signal flow memory (for program).
- For a function, the signal flow memory is not assigned since the instructions that refer to the last execution status of the signal flow memory cannot be used in the function.
- For a subroutine-type function block, the same number of areas as the function block steps are assigned to the signal flow memory (for FB). Different areas are assigned to each instance. When the macro type function block is called from the subroutine type function block, the areas including the ones used for the macro type function block are assigned.
- For a macro type function block, the same number of areas as the number of steps of the macro type function block are assigned to the signal flow memory (for program).

For instances of the function block, refer to the following.

📖 MELSEC iQ-F FX5 Programming Manual (Program Design)

Point

The signal flow unit is 1 bit.

[FX5UJ CPU module]

The program capacity is fixed at 48000 steps, and the capacity of the signal flow memory is as follows.

- Signal flow memory (for program): 48000 step (6000 byte)
- Signal flow memory (for FB): 131072 step (16K byte)

[FX5U/FX5UC CPU module]

The capacity of the signal flow memory varies according to the program capacity setting.

- Signal flow memory (for program)
 - 64000 step...64000 step (8000 byte)
 - 128000 step...128000 step (16000 byte)
- Signal flow memory (for FB)
 - 64000 step...131072 step (16K byte)
 - 128000 step...262144 step (32K byte)

Temporary area

This area is used temporarily by the system during the scan process. It is used as the label defined by the function or the instruction operand added by the system. Part of the temporary area is occupied when execution of the function or instruction is started. The area is released when the execution is completed.

Examples of changes in the state of temporary area when executing a function are shown below.

Program example

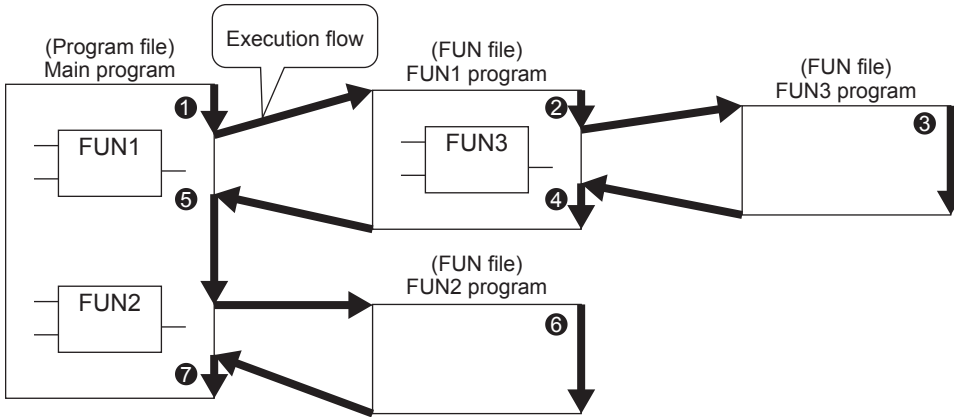

Changes in the state of temporary area

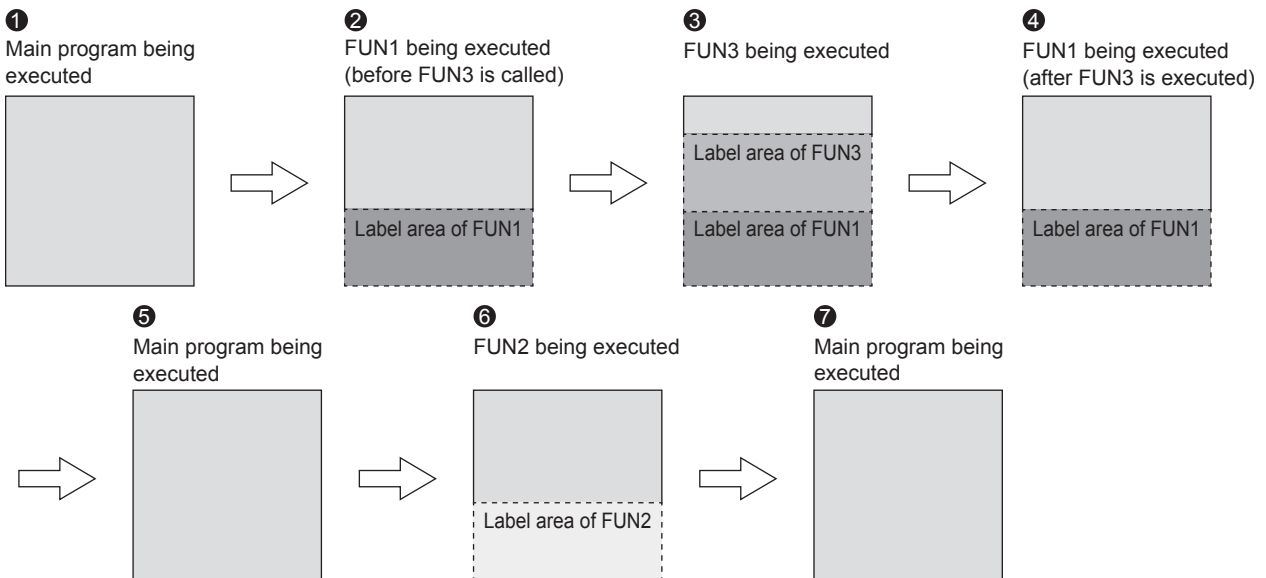

Point

[FX5UJ CPU module]

The capacity of temporary area is 32767 word.

[FX5U/FX5UC CPU module]

The capacity of the temporary area varies according to the program capacity setting.

- 64000 step...700 word
- 128000 step...32767 word

SD memory card

The following files are stored in SD memory card.

Category	File type	Max. number of files	Remarks
Program	Program file	32	—
	FB files	16 (Up to 15 for user)	—
Parameters	Parameter files common to system	1	—
	CPU parameter file	1	—
	Module parameter file	1	—
	Module extension parameter	18	—
	Memory card parameter	1	—
	Remote password	1	—
	Global label setting file	1	—
	Data logging setting file	4	—
	Initial device value file	1	—
	Slave station parameter file ^{*1}	80 ^{*2}	—
Comments	Device comment file	1	—
Extended file register	Extended file register file	1	—

*1 Only FX5U/FX5UC CPU module is supported.

*2 When the firmware version of the FX5U/FX5UC CPU module is "1.230" or earlier, the maximum number of the files is 60.

3.2 Files

The CPU module files are explained below.

File type and storage destination memory

File types and their storage destination memory are explained below.

○: Can be stored, ×: Cannot be stored

File type	CPU built-in memory	SD memory card	File name (extension)
	Data memory		
	Drive No.4	Drive No.2	
Program	○	○	ANY_STRING.PRG
FB files	○	○	ANY_STRING.PFB
CPU parameters	○	○	CPU.PRM
System parameters	○	○	SYSTEM.PRM
Module parameters	○	○	UNIT.PRM
Module extension parameter (for intelligent module)	○	○	UEXmmmmn.PRM ^{*2}
Memory card parameter	×	○	MEMCARD.PRM
Device comments	○	○	ANY_STRING.DCM
Device initial values	○	○	ANY_STRING.DID
Event history	○	○	EVENT.LOG
Device data storage file	○	○ ^{*1}	DEVSTORE.QST
Global label setting file	○	○	GLBLINF.IFG
General-purpose data	×	○	ANY_STRING. (CSV/BIN)
Data logging setting file	○	○	LOGnn.LIS ^{*3}
Memory dump setting file	○	×	MEMDUMP.DPS
Remote password	○	○	00000001.SYP
Module extension parameter (for protocol setting)	○	○	UEX3FF01.PPR ^{*4} UEX3FF00.PPR ^{*5}
Firmware update	×	○	<ul style="list-style-type: none"> ■FX5UJ CPU module • F5Jnvvv.SYF^{*6} ■FX5U/FX5UC CPU module • F50nvvv.SYF^{*6} ■Intelligent module • F5mmvvv.SYF^{*7}
Firmware update prohibited	○	○ ^{*1}	FWUPDP.SYU
System file for backing up CPU module data	×	○	\$BKUP_CPU_INF.BSC
Device/label data file for backing up CPU module data	×	○	BKUP_CPU_DEVLAB.BKD
System file for CPU module auto exchange function	×	○	\$BKUP_CPU_EXCHANGE.DAT
Extended file register file	×	○	EXFILER.ERD
Slave station parameter file	○	○	SLAVEmmmmnnnoooo.NSP ^{*8*9}
Web server binary file	×	○	F5WebFilexxxxx.HVF ^{*10}

*1 Can be stored but cannot operate as a function.

*2 mmm indicates the module number (3-digit hexadecimal). nn is the serial number (2-digit hexadecimal) for each module.

*3 nn corresponds to the setting number and is 01 through 04.

*4 For serial communications file.

*5 For Ethernet file.

*6 n is 0 through F.

vvvv is the version information. (4-digit decimal)

*7 mm is the intelligent module information.

vvvv is the version information. (4-digit decimal)

*8 mmm is the module number, nnn is the number of modules, and oooo is the serial number.

*9 Only FX5U/FX5UC CPU module is supported.

*10 xxxxxx is the version information.

Executable file operations

File operations that can be executed on each file are explained below. This operation is possible only when the operation status of the CPU module is the STOP status.

○: Can be executed, —: No corresponding operation

File type	Operation with engineering tool			Operation with FTP server function ^{*1}			Operation via instruction ^{*3}	
	Write	Read	Delete	Write ^{*2}	Read	Delete	Write	Read
Program	○	○	○	○	○	○ ^{*5}	—	—
FB files	○	○	○	○	○	○ ^{*5}	—	—
Parameters	○	○	○	○	○	○ ^{*5}	—	—
Device comments	○	○	○	○	○	○ ^{*5}	—	—
Device initial values	○	○	○	○	○	○ ^{*5}	—	—
Global label setting file	○	○	○	○	○	○ ^{*5}	—	—
Device data storage file	—	—	—	○ ^{*5}	○	○ ^{*5}	○	○
General-purpose data	○	○	○	○	○	○	○	○
Data logging setting file	○ ^{*6}	○ ^{*6}	○ ^{*6}	○	○	○	—	—
Memory dump setting file	○	○	○	×	×	×	—	—
Remote password	○	○	○	○	○	○ ^{*5}	—	—
Firmware update prohibited file	○	○	○	○	○	○	—	—
System file for backing up CPU module data	—	—	—	○	○	○ ^{*5}	—	—
Device/label data file for backing up CPU module data	—	—	—	○	○	○ ^{*5}	—	—
System file for CPU module auto exchange function	—	—	—	○	○	○ ^{*5}	—	—
Extended file register file	○	○	— ^{*7}	○	○	○ ^{*5}	○ ^{*8}	○
Slave station parameter file ^{*4}	○	○	○	○	○	○ ^{*5}	—	—

*1 Only files stored on the SD memory card (drive No. 2) are the target.

*2 Writing is possible when the "Allow Online Change" is set to "Enable" with the FTP server settings.

*3 Modification of data in files, such as execution of the ERREAD/ERWRITE/ERINIT instruction or SP.FWRITE/SP.FREAD instruction.

*4 Only FX5U/FX5UC CPU module is supported.

*5 Available only when the CPU module operation status is STOP. A communication error occurs when operated in the RUN state.

*6 Operation on CPU Module Logging Configuration Tool.

All the file operation of the target memory during data logging execution is possible.

*7 The extended file registers (ER) can be initialized at once.

*8 The extended file registers (ER) can be initialized at once by the ERINIT instruction.

3.3 Memory Operation

Initialization and value clear

Each memory can be initialized and cleared to zero by using the engineering tool. For details on the operation method, refer to the following.

 GX Works3 Operating Manual

Items to be specified in the engineering tool		Target	
Initialization	Data memory	Deletes all the folders and files in the program memory and data memory.	
	SD memory card	Deletes all the folders and files in the SD memory card.	
Clear value (when CPU built-in memory is selected)	Device, Label	Zero clear	Excluding devices and labels with latch specified, clears the following to zero: X, Y, M, L, B, F, SB, S, T, ST, C, LC, D, W, SW, Z, LZ, R, and all labels (including module labels).
		Zero clear (including Latches (1) and (2))	Including devices and labels with latch specified, clears the following to zero: X, Y, M, L, B, F, SB, S, T, ST, C, LC, D, W, SW, Z, LZ, R, and all labels (including module labels).
Clear value (when SD memory card is selected)		Initializes all extended file registers (ER) with FFFFH.	

3

Point

If the power goes off during initialization or zero clear, the memory is left in the state of that point, and it is necessary to re-execute the memory operation.

Memory initialization during execution of another function

No memory can be initialized during execution of the following function. Check that the following function is not being executed and then initialize the memory.

- CPU module data backup/restoration function

Clearing values during execution of another function

■ CPU module data backup/restoration function

During execution of the CPU module data backup/restoration function, devices, labels, and latch areas cannot be cleared to zero. Check that the CPU module data backup/restoration function is not being executed and then clear devices, labels, and latch areas to zero.

PART 2 FUNCTIONS

This part consists of the following chapters.

4 FUNCTION LIST

5 FIRMWARE UPDATE FUNCTION

6 SCAN MONITORING FUNCTION

7 CLOCK FUNCTION

8 ONLINE CHANGE

9 INTERRUPT FUNCTION

10 PID CONTROL FUNCTION

11 CONSTANT SCAN

12 REMOTE OPERATION

13 DEVICE/LABEL MEMORY AREA SETTING

14 PROGRAM CAPACITY SETTING

15 INTERNAL BUFFER CAPACITY SETTING

16 INITIAL DEVICE VALUE SETTING

17 LATCH FUNCTION

18 MEMORY CARD FUNCTION

19 DEVICE/LABEL ACCESS SERVICE PROCESSING SETTING

20 DATA LOGGING FUNCTION

21 MEMORY DUMP FUNCTION

22 REAL-TIME MONITOR FUNCTION

23 RAS FUNCTIONS

24 DATA BACKUP/RESTORATION FUNCTION

25 SECURITY FUNCTIONS

26 HIGH-SPEED INPUT/OUTPUT FUNCTION

27 BUILT-IN ANALOG FUNCTION

4 FUNCTION LIST

The following table lists the functions of the CPU module.

○: Supported, △: Limitedly supported, ×: Not supported

Function		Description	Function support		Reference
			CPU module		
			FX5UJ	FX5U/ FX5UC	
Firmware update function		This function updates the module's firmware using an SD memory card.	○	○	Page 53
Scan monitoring function (Watchdog timer setting)		Detects an error in the hardware and program of the CPU module by monitoring the scan time.	○	○	Page 66
Clock function		This function is used for the time management in the function which the system operates such as the date of the event history function, and data logging function.	○	○	Page 68
Online change	Changing ladder blocks while online	Writes the part of a program edited on the ladder editor using the engineering tool to the CPU module in units of ladder blocks. Edited contents spanning multiple portions can be written to the CPU module at once.	○	○	Page 72
Interrupt function	Multiple interrupt function	When an interrupt occurs while an interrupt program triggered by another cause is running, stops the program if its priority is lower than that of the new interrupt, and runs the higher-priority program whenever its execution condition is satisfied.	○	○	Page 75
PID control function		Performs PID control by the PID control instruction.	○	○	Page 77
Constant scan		Keeps the scan time constant and executes program repeatedly.	○	○	Page 114
Remote operation	Remote RUN/STOP	Changes the CPU module status to the RUN/STOP/PAUSE status externally while the RUN/STOP/RESET switch of the CPU module is in RUN status.	○	○	Page 116
	Remote PAUSE				
	Remote RESET	Resets the CPU module externally while the CPU module is in the STOP status.	○	○	
Device/label memory area setting		Sets the capacity of each area in the device/label memory.	×	○	Page 121
Program capacity setting		Set to change program capacity.	×	○	Page 127
Internal buffer capacity setting		Sets the capacity of the area (internal buffer) used by the system to temporarily store the results of data logging and memory dump processing.	○	○	Page 128
Initial device value setting		Sets the initial values of devices used in the program directly (not via the program) to the devices.	○	○	Page 130
Latch function		Holds the contents of the device and label of the CPU module when the power is turned ON etc.	○	○	Page 132
Memory card function	SD memory card forced stop	Makes the SD memory card unavailable without turning OFF the power even when the function accessing the SD memory card is executed.	○	○	Page 137
	Boot operation	Transfers the file stored in the SD memory card to the transfer destination memory judged automatically by the CPU module when the power is turned ON or is reset.	○	○	
Device/label access service processing setting		Sets the number of execution times of the device/label access service processing executed by END processing, with parameter.	○	○	Page 141
Data logging function		Collects data at the specified interval or any desired timing, and stores them as a file on the SD memory card.	○	○	Page 144
Memory dump function		Saves the data in the devices of the CPU module at a desired timing.	○	○	Page 179
Real-time monitor function		Monitors the data in the specified device of the CPU module at a specified interval or at a desired timing in real time.	○	○	Page 188

Function		Description	Function support		Reference
			CPU module		
			FX5UJ	FX5U/ FX5UC	
RAS function	Self-diagnostics function	Self-diagnoses the CPU module to see whether an error exist or not.	○	○	Page 190
	Error clear	Batch-clears all the continuation errors being detected.	○	○	
	Event history function	Collects operations executed and errors detected from the modules, and saves them in the CPU module, expansion board, expansion adapter, and intelligent module. The saved logs can be checked in chronological order.	○	○	
Data backup/restoration function		Backs up program files, parameter files, and device/label data files in a CPU module to an SD memory card. The backup data can be restored as needed.	○	○	Page 199
Security function		Protects resources stored in PCs and resources in the units in the system of the FX5 from illegal access by a third party such as theft, alteration, accidental operation and unauthorized execution.	○	○	Page 219 GX Works3 Operating Manual
IP filter function		Identifies the IP address of external devices over Ethernet, and blocks access from an invalid IP address.	○	○	MELSEC iQ-F FX5 User's Manual (Ethernet Communication)
High-speed input/output function	High-speed counter function	Performs high-speed counter, pulse width measurement, input interruption, etc. by using the input of the CPU module or high-speed pulse input/output module.	△	○	Page 220
	Pulse width measurement function				Page 302
	Input interrupt function				Page 369
	Positioning function	Executes positioning operation by using the transistor output of the CPU module or high-speed pulse input/output module.	△	○	MELSEC iQ-F FX5 User's Manual (Positioning Control - CPU module built-in, High-speed pulse input/output module)
	PWM output function	Executes a PWM output by using the transistor output of the CPU module or high-speed pulse input/output module.	△	○	Page 332
Built-in analog function	Analog input function	Two analog inputs and one analog output are built in the FX5U CPU module so that voltage input/voltage output can be performed.	×	○*1	Page 346 MELSEC iQ-F FX5 User's Manual (Analog Control - CPU module builtin, Expansion adapter)
	Analog output function				
Built-in Ethernet function		An Ethernet related function such as connection to MELSOFT products and GOTs, socket communication, file transfer function (FTP server, FTP client), Web server (HTTP), SNMP client, and simple CPU communication function.	△	○	MELSEC iQ-F FX5 User's Manual (Ethernet Communication)
CC-Link IE Field Network Basic function		This function exchanges data between the master station and slave station using general-purpose Ethernet.	○	○	CC-Link IE Field Network Basic Reference Manual
Serial communication function		A function related to the serial communication such as N:N Network, parallel link, MC protocol, inverter communication function and non-protocol communication.	○	○	MELSEC iQ-F FX5 User's Manual (Serial Communication)
MODBUS communication function		Connection with the products which support MODBUS RTU/TCP is available. The master and slave functions can be used.	○	○	MELSEC iQ-F FX5 User's Manual (MODBUS Communication)
SFC function		Executes programs written in sequential function chart (SFC).	×	○	MELSEC iQ-F FX5 Programming Manual (Program Design)

*1 Only FX5U CPU module is supported.

5 FIRMWARE UPDATE FUNCTION

This function is used when the user obtains the firmware update file from the Mitsubishi Electric FA website, and updates the firmware version.

The firmware can be updated by the following methods.

Method	Description
Update using an SD memory card	The CPU module firmware can be updated only with an SD memory card without using any special tool.
Update using the engineering tool	The intelligent module firmware can be updated by using the engineering tool.

For supported version of firmware update function, refer to  Page 566 Added and Enhanced Functions.

5.1 Update Using an SD Memory Card

The CPU module firmware can be updated by using an SD memory card. The firmware can be updated only with an SD memory card without using special software.

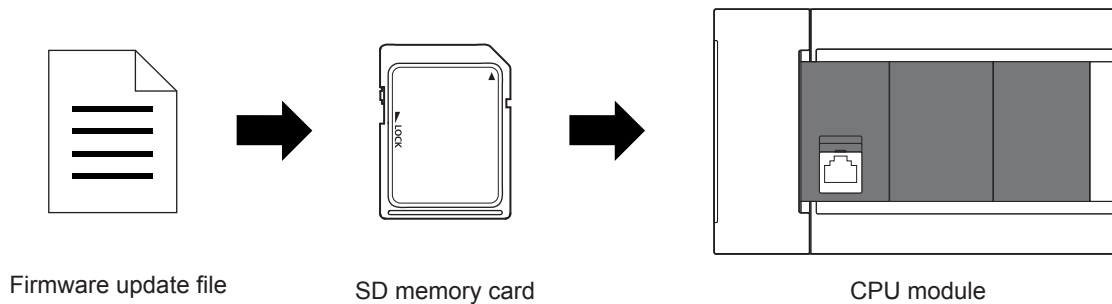

Point

- In system configurations where the CPU module (system) for which the firmware to be updated is connected to a network, etc., an error may occur when the firmware update is executed. Therefore, confirm the system's safety before executing the firmware update.
- Back up the various data such as the programs and parameters before executing the firmware update.

Target models

The target models are listed below.

Product name	Model name
CPU module	FX5UJ CPU, FX5U CPU, FX5UC CPU

CPU module firmware update

Firmware update method

■Preliminary preparations

1. Download the firmware update information for the model to be updated from the Mitsubishi Electric FA website. The firmware update information is a ZIP file that contains the firmware update file, Web page update file^{*1} and firmware update prohibited file.

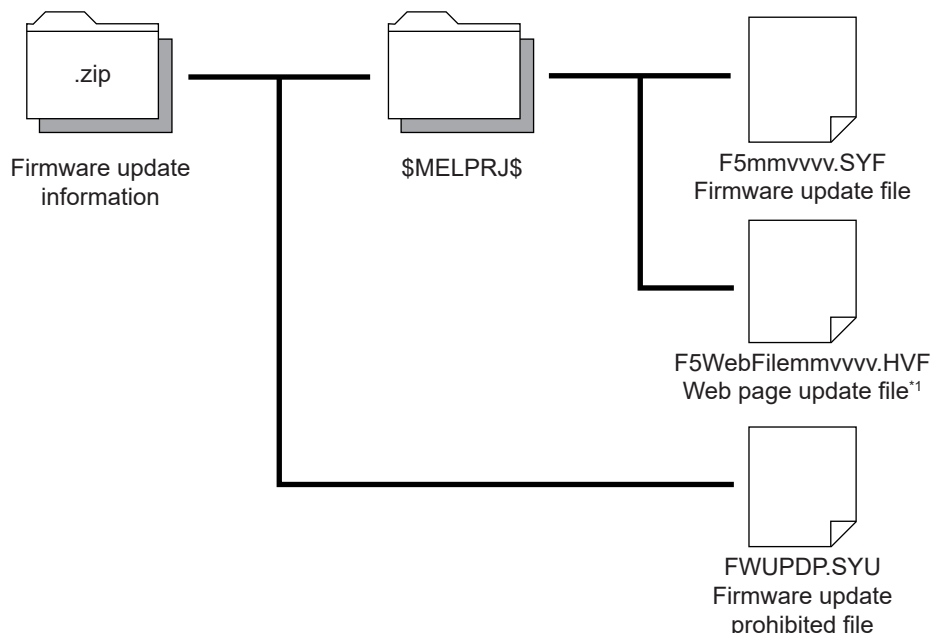

2. Decompress the firmware update information (ZIP file).
3. Store the "\$MELPRJ\$" containing the firmware update file and Web page update file^{*1} into the root folder of the SD memory card using a personal computer. When another "\$MELPRJ\$" is already stored in the SD memory card, delete the "\$MELPRJ\$" and then store the "\$MELPRJ\$" containing the firmware update file.

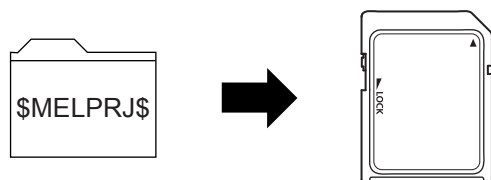

Restriction

When updating the firmware to version "1.060" and later on the FX5U/FX5UC CPU module, store the firmware update file and Web page update file in the same firmware update information (ZIP file) into the \$MELPRJ\$ folder. If the files which are not compatible with each other are stored into the \$MELPRJ\$ folder, the update will not be completed.

4. If updating of the firmware is prohibited, cancel the prohibit setting. (☞ Page 57 Canceling the firmware update prohibited setting)



Restriction

Store the "\$MELPRJ\$" folder into the SD memory card using a personal computer. The "\$MELPRJ\$" folder cannot be written into the SD memory card with the engineering tool.

5. Back up the various data such as the programs and parameters before executing the firmware update. Also, use the backup/restoration function to hold latch devices. (☞ Page 199 DATA BACKUP/RESTORATION FUNCTION)

^{*1} The file attached to the firmware update information (ZIP file) of FX5U/FX5UC CPU module with firmware version "1.060" and later. The file is required when updating the firmware version "1.060" and later. For the FX5UJ CPU module, the file is required from the first version.

■Operation

1. Execute RUN→STOP and turn the CPU module power OFF, and insert the SD memory card into the CPU module.
2. Turn the CPU module power ON and wait until the RUN LED and ERR LED blink.*1 When the LED does not blink, refer to step 1 of  Page 59 Troubleshooting.
3. Confirm that the RUN LED and ERR LED blink slowly, and then restart or reset the CPU module.
4. The RUN LED and ERR LED blink slowly. Wait until the LED turns off. When the LED does not blink (for up to 45 seconds), refer to step 2 of  Page 59 Troubleshooting.
5. Confirm that the RUN LED and ERR LED turn off, and then restart or reset the CPU module.
6. The RUN LED and ERR LED blink slowly. Wait until the LED turns off.*2*3
7. After PWR LED turns on, check the engineering tool's Module Diagnosis (CPU Diagnosis) screen, and confirm that the firmware version has been updated.

 [Diagnostics] ⇒ [Module Diagnostics(CPU Diagnostics)]

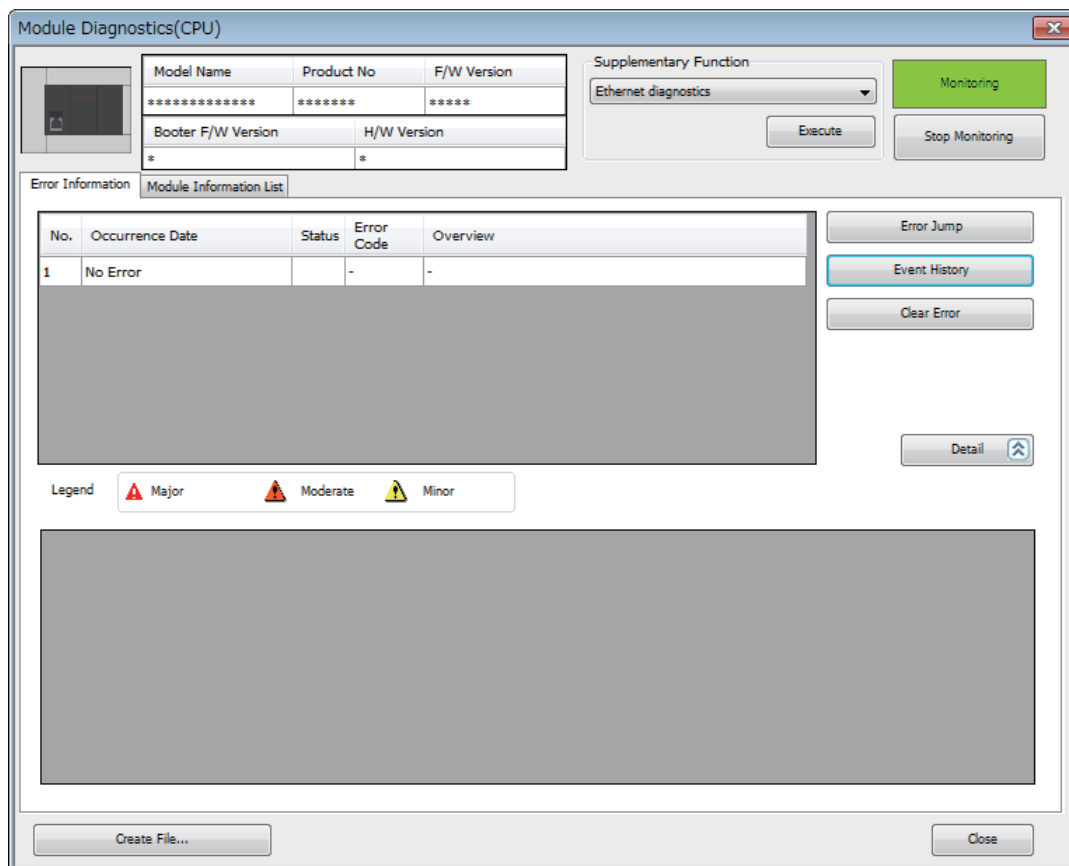

8. Turn the CPU module power OFF and remove the SD memory card. Delete the firmware update file from the removed SD memory card.

- *1 The waiting time is as follows.
- FX5UJ CPU module: Up to 120 seconds
 - FX5U/FX5UC CPU module: Up to 90 seconds

- *2 The waiting time is as follows.
- FX5UJ CPU module: Up to 90 seconds
 - FX5U/FX5UC CPU module: Up to 90 seconds

*3 This operation is required when the firmware version of FX5U/FX5UC CPU module is "1.045" and later.

Point

- Communication with other modules and communication with the engineering tool or external devices is not possible while the firmware update is being executed.
- During firmware update, the data memory will be backed up*4 to the SD memory card.
- If the firmware is updated correctly, the data memory will be restored*4 from the SD memory card to the CPU built-in memory. After the file is restored, the data memory backup file in the SD memory card will be deleted.
- If the CPU module is restarted or reset after recovery of the data memory, recovery retry*5 will be executed. The RUN LED and ERR LED blink slowly (5 seconds or more) when recovering the data memory with retry. The LED will turn OFF when the file is correctly recovered. If the recovery fails again, the ERR LED will blink.
- The firmware version can also be confirmed with the special register (SD8001).
- After the firmware is updated, if a firmware update file that differs from the CPU module's firmware version is stored in the "\$MELPRJ\$" folder of the SD memory card, the firmware will be updated.

*4 Refer to Page 566 Added and Enhanced Functions for the versions that support data memory save/recovery of FX5U/FX5UC CPU module.

*5 Refer to Page 566 Added and Enhanced Functions for the versions that support data memory recovery retry of FX5U/FX5UC CPU module.

Firmware update prohibited setting

Updating of the firmware can be prohibited by writing the firmware update prohibited file into the CPU module.

1. Using the engineering tool, select the folder containing the firmware update prohibited file (FWUPDP.SYU) as the write target file, and select the CPU built-in memory for the write target. The firmware update prohibited file is stored in the firmware update information downloaded during the preliminary preparations. (Page 54 Firmware update method)

[Online] ⇒ [User Data] ⇒ [Write]

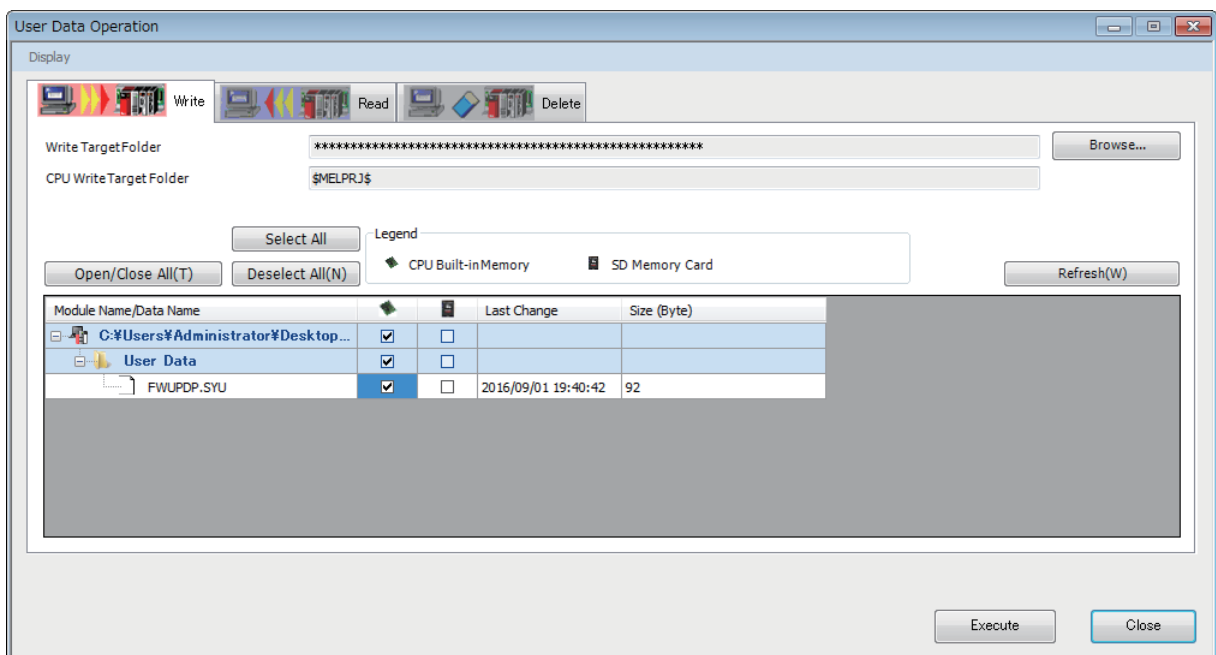

2. Using the engineering tool, set a file password for the firmware update prohibited file.*1

[Project] ⇒ [Security] ⇒ [File Password Setting]

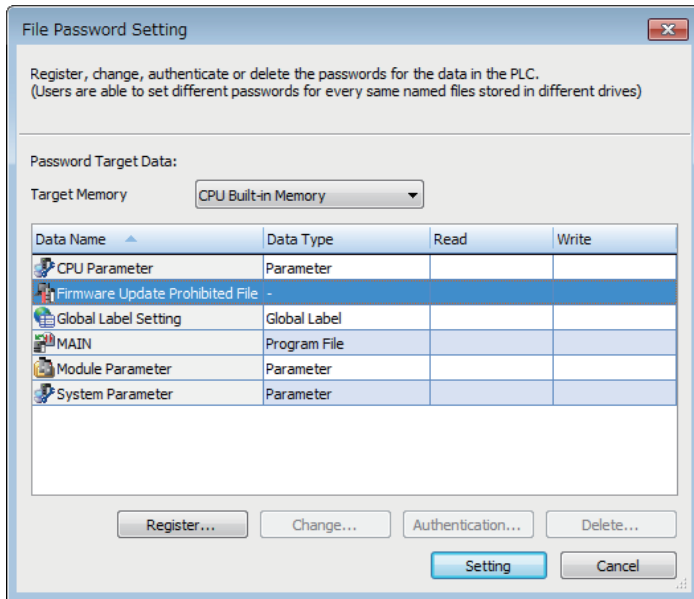

For details on operation, refer to the following.

📖 GX Works3 Operating Manual

*1 Refer to 📖 Page 566 Added and Enhanced Functions for the versions that support file password setting for the firmware update prohibited file.

Point

The firmware update permit/prohibit state can be confirmed with the special relay (SM912).

Canceling the firmware update prohibited setting

When executing the firmware update, cancel the prohibit setting with the engineering tool.

1. Delete the file password for the firmware update prohibited file.

[Project] ⇒ [Security] ⇒ [File Password Setting]

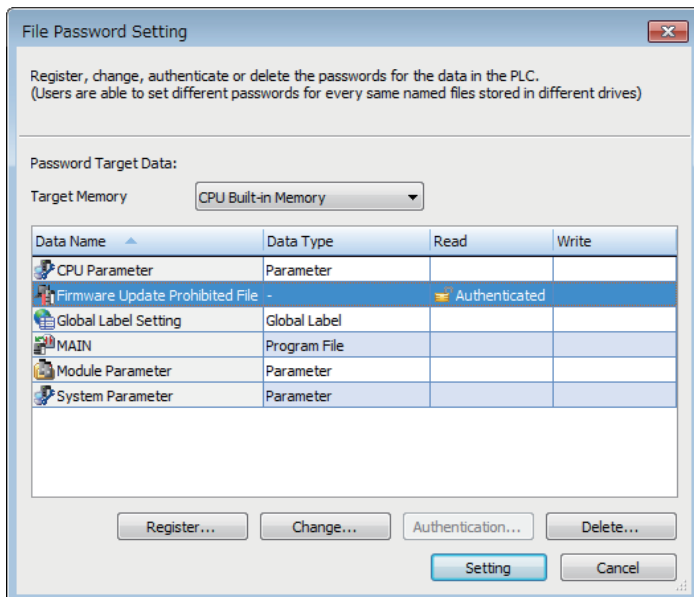

2. Delete the firmware update prohibited file from the CPU built-in memory.

[Online] ⇒ [User Data] ⇒ [Delete]

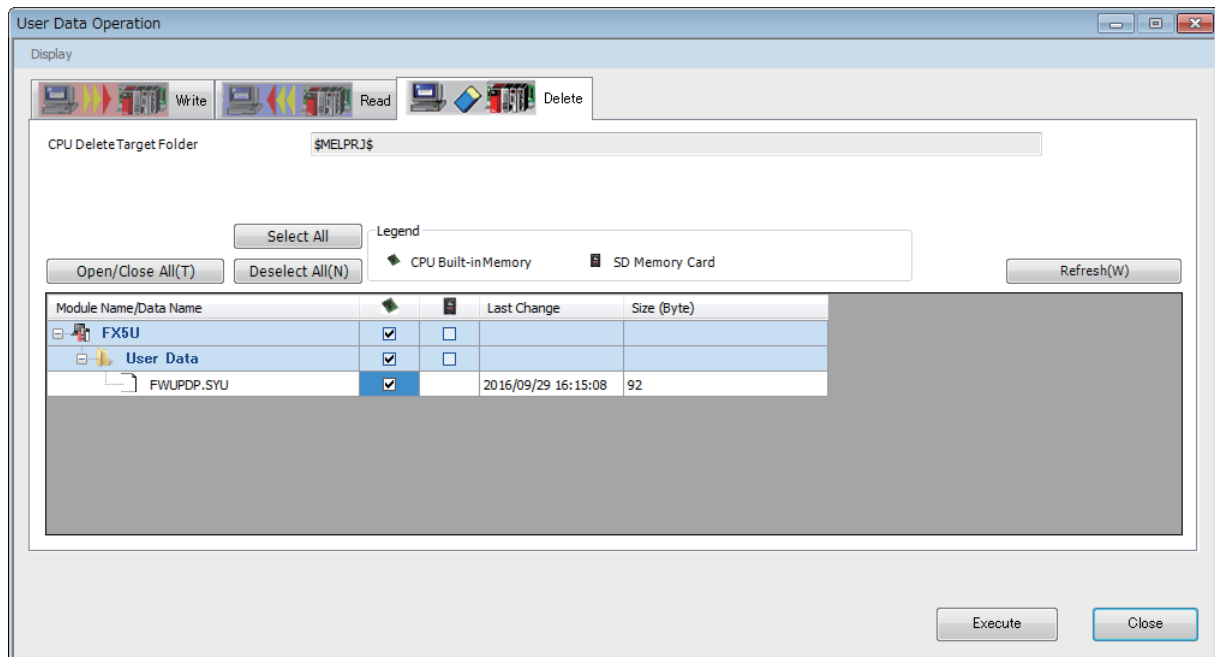

Point

The firmware update prohibited file can also be deleted with the following method. Note that the program, etc., will also be deleted.

- Memory operation (initialization) (📖 GX Works3 Operating Manual)
- Clearing the CPU built-in memory before booting with boot operation (👉 Page 139 Boot Operation)

Precautions

- Back up the various data such as the programs and parameters before executing the firmware update.
- Check the target model, and download the correct firmware update file from the Mitsubishi Electric FA website. The firmware will not be updated if the target model does not match.
- Do not change the data (folder and file name) downloaded from the Mitsubishi Electric FA website.
- Do not turn the power OFF or reset the CPU module while the firmware update is in progress. Doing so may cause programs to be deleted.
- Do not remove the SD memory card while the firmware update is in progress. If the SD memory card is removed before the firmware update finishes, the process may end with an error.
- When the firmware version of the CPU module is updated by the firmware update function, some functions have restrictions depending on the serial No. For details on operation, refer to 👉 Page 566 Added and Enhanced Functions.
- To update the firmware of the CPU module to version "1.100" or later, use the CPU module with serial No. as follows.
 - FX5UC-32MT/DS-TS and FX5UC-32MT/DSS-TS: Serial No. 178****
 - FX5U/FX5UC CPU module other than the above: Serial No. 17X****
- For the FX5U/FX5UC CPU module with the serial No. 2114001 or later, downgrading to previous firmware version "1.220" or earlier cannot be performed. Update error (3040H) will occur and the firmware will not be updated.
- For the FX5UJ CPU module with the serial No. 2154001 or later, downgrading to previous firmware version "1.010" or earlier cannot be performed. Update error (3040H) will occur and the firmware will not be updated.

Troubleshooting

If an error occurs, take corrective action according to the error code. (☞ Page 473 List of error codes)

If the error cannot be judged by the error code, check the following items and troubleshoot the situation.

Procedure	Error details	Action
1	The LED turns off and does not blink.	<ul style="list-style-type: none">• Check that the SD memory card is inserted.• Check whether the folder name and file name to be stored in the SD memory card are correct.• Check whether the same firmware version has already been written in.• Obtain the firmware update file from the Mitsubishi Electric FA website, and update the file in the SD memory card.
2	The RUN LED turns off and the ERR LED is blinking.	Reset the CPU module. If the same situation occurs again, the hardware of the CPU module may be malfunctioning. Consult your local Mitsubishi Electric representative.

5.2 Update Using the Engineering tool

The intelligent module firmware can be updated by using the engineering tool.

Write the firmware update information from the engineering tool to the CPU module. The firmware of the target module can be changed by the CPU module by writing the firmware information to the target module to be updated. (Hereinafter, the CPU module that writes the firmware update information is referred to as the update writing CPU module.)

An SD card must have been installed in the update writing CPU module in advance.

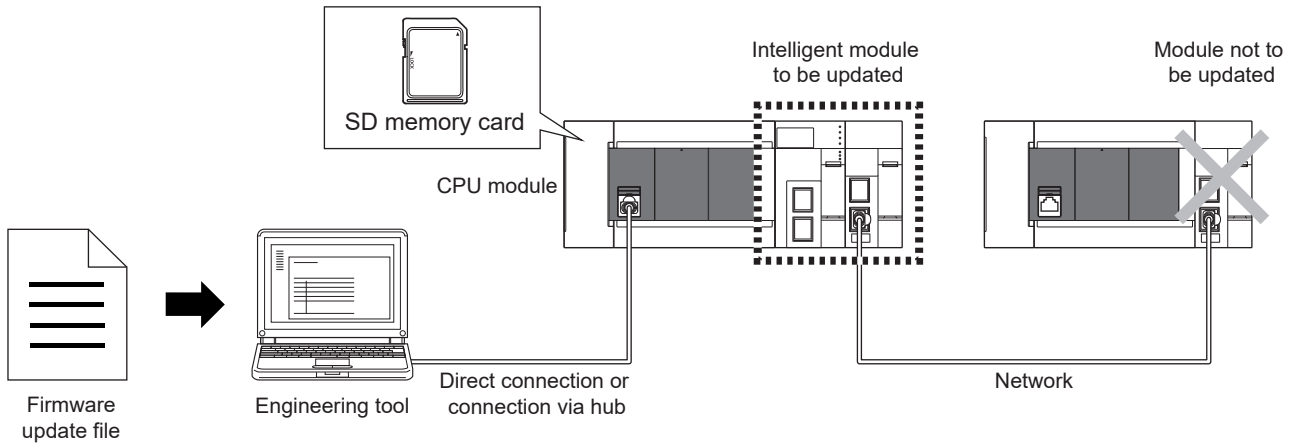

Point

- In other system configurations where the intelligent module (system) for which the firmware to be updated is connected with a network, etc., an error may occur when the firmware update is executed. Therefore, confirm the system's safety before executing the firmware update.
- Back up the various data such as the programs in the CPU module and parameters before executing the firmware update.
- Only one intelligent module can be updated by executing the function once.
- The intelligent modules connected on the network are excluded for the firmware update.

Target models

The target modules to be updated, and the models and versions compatible with the update writing CPU module are shown below.

■ Target modules to be updated

The firmware of the following models can be updated.

Product	Model	Firmware version of the update writing CPU module	Firmware version of the target module	Serial No. of of the target module	Version of the engineering tool
Intelligent module	FX5-ENET	"1.240" and above	"1.003" and above	209**** and above	"1.075D" and above
	FX5-ENET/IP		"1.003" and above	209**** and above	
	FX5-CCLIEF		"1.005" and above	20X**** and above	
	FX5-CCLGN-MS		Initial product and above	Initial product and above	
	FX5-40SSC-G		Initial product and above	Initial product and above	
	FX5-80SSC-G		Initial product and above	Initial product and above	

Point

If the CPU module is not compatible, update the CPU module via an SD memory card. (☞ Page 53 Update Using an SD Memory Card)

■Update writing CPU module

The CPU modules that can write the firmware update file to the intelligent modules via the engineering tool are shown below.

Product	Model
CPU module	FX5U CPU, FX5UC CPU

Supported engineering tool

The engineering tool supporting the firmware update function (update method using the engineering tool) is shown below.

Product	Model
Engineering tool	GX Works3

Communication route

The communication routes between the engineering tool supporting the firmware update function (update method using the engineering tool) and the CPU module are shown below. For details, refer to [MELSEC iQ-F FX5 User's Manual \(Ethernet Communication\)](#).

■Direct Connection

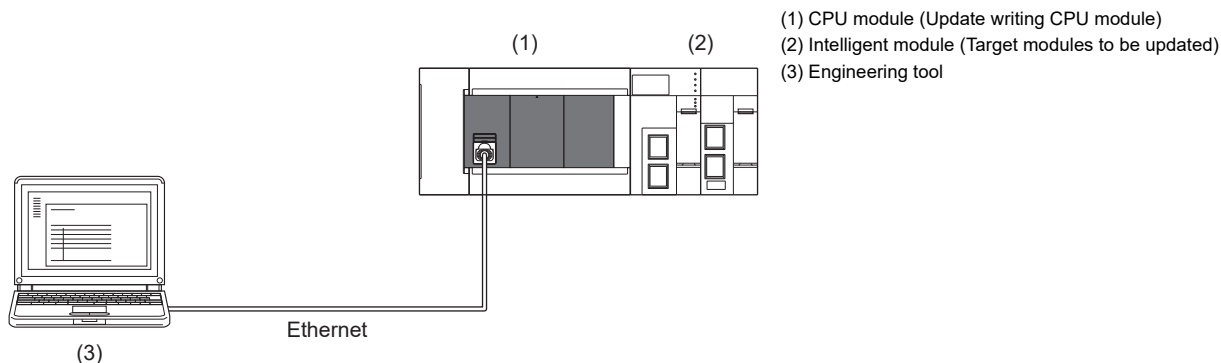

■Connection via hub

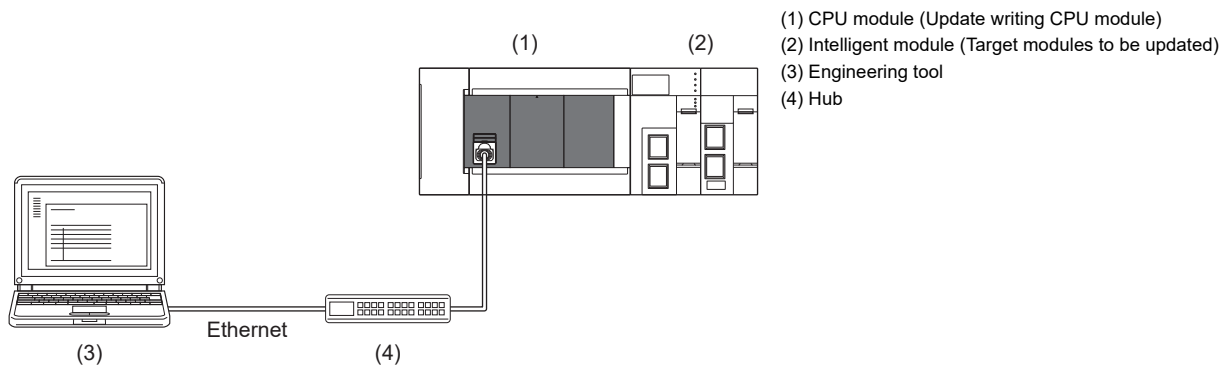

Connection via GOT Transparent is not supported.

Firmware update method

■Preliminary preparations

1. Download the firmware update information for the model to be updated from the Mitsubishi Electric FA website. (Firmware update file: F5mmvvv.SYF)
2. If updating of the firmware is prohibited, cancel the prohibit setting. (☞ Page 57 Canceling the firmware update prohibited setting)
3. Back up the various data such as the programs and parameters before executing the firmware update. Also, use the backup/restoration function to hold latch devices. (☞ Page 199 DATA BACKUP/RESTORATION FUNCTION)
4. Enable remote RESET. (☞ Page 119 Enabling remote RESET)
5. Execute RUN→STOP and turn the CPU module power OFF, and insert the SD memory card into the CPU module.

Restriction

If the SD memory card contains the firmware update files of the CPU module and intelligent module, the firmware cannot be updated. Delete the firmware update files of the CPU module and intelligent module from the SD memory card before starting the update.

■Operation

1. Turn the CPU module power ON.
2. Display the firmware update screen of the engineering tool.

☞ [Tool] ⇒ [Update Firmware]

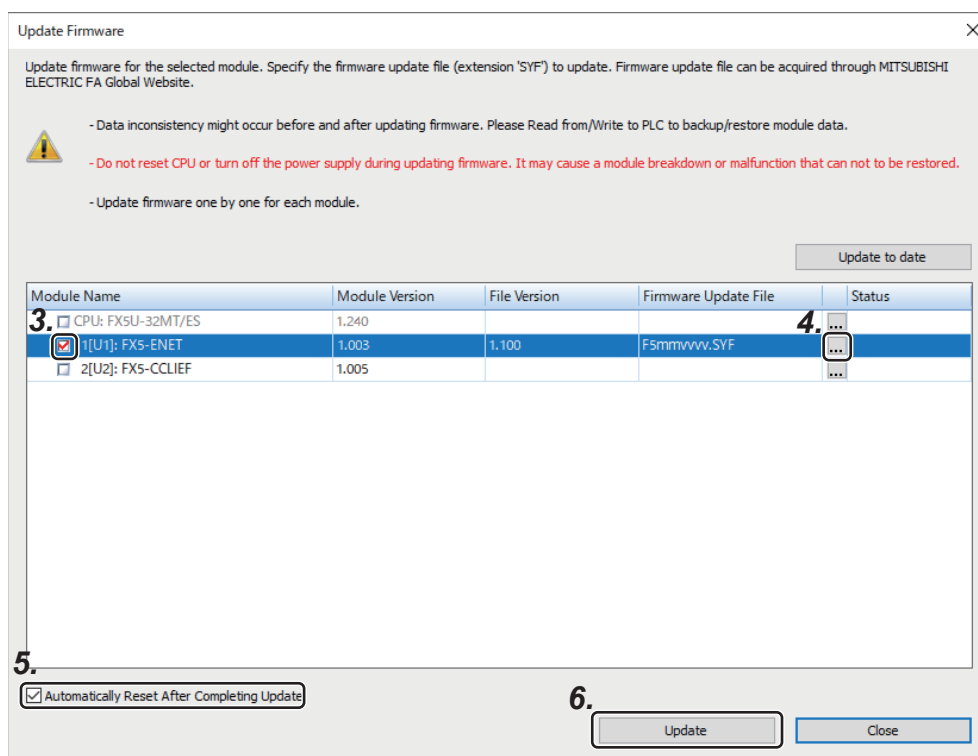

3. Select the intelligent module whose firmware will be updated.
4. Click [...], and select the firmware update file.
5. Select whether to automatically reset *1.
6. Click [Update] to update the firmware. It takes about 10 minutes to complete the update. After the firmware update is started, the update status *2 can be checked in the "Status" column.

7. If you did not check the box in 5 (Not automatically reset), turn the system power OFF and ON after the completion of the firmware update.
8. To prohibit the remote RESET, disable remote RESET. (☞ Page 119 Enabling remote RESET)
9. On the module diagnosis (intelligent module) screen of the engineering tool, confirm that the firmware has been updated to the latest version.

☞ [Diagnostics] ⇒ [System Monitor] ⇒ [Target module (intelligent module)]

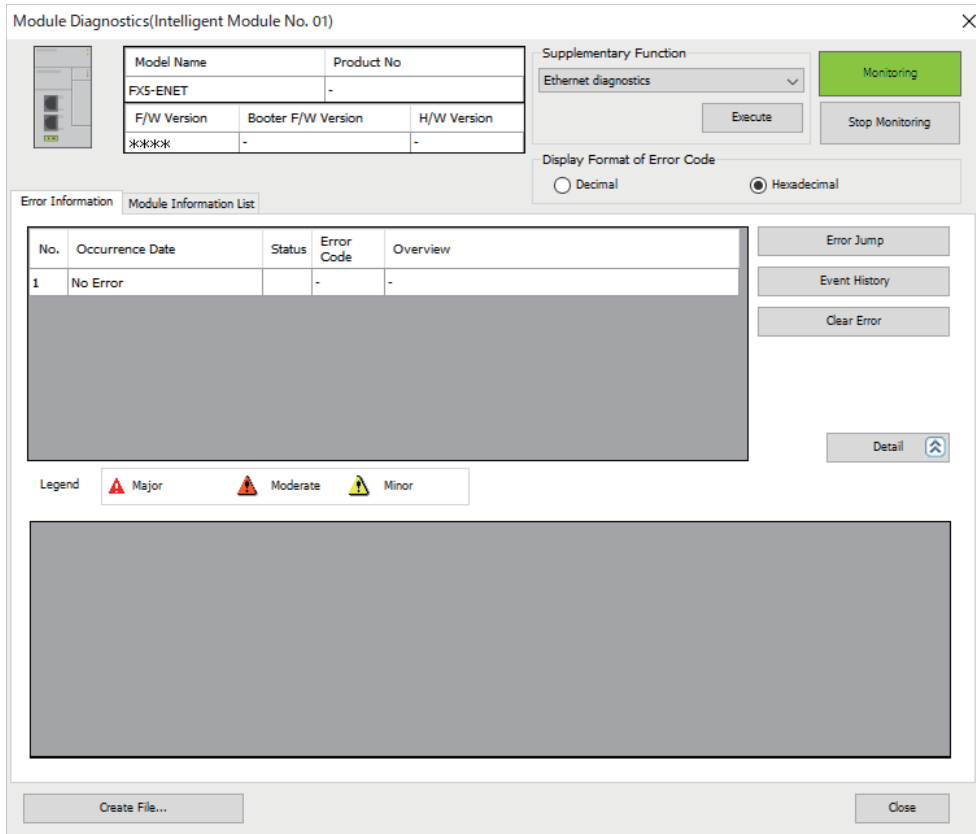

- *1 Select the operation to be performed after the completion of the firmware update.
 - Checked: The CPU module will be automatically reset.
 - Unchecked: The CPU module will not be automatically reset. (The module will wait until it is manually reset after the completion of the update.)
- *2 During transfer: The update file is being transferred.
 During transition/during execution: The firmware is being updated.
 Completed: The firmware update is completed normally.
 Error: The firmware update is completed abnormally.

Firmware update prohibited setting

For the firmware update prohibited setting, refer to the following.

- ☞ Page 56 Firmware update prohibited setting
- ☞ Page 57 Canceling the firmware update prohibited setting

Precautions

- Check the target model, and download the correct firmware update file from the Mitsubishi Electric FA website. The firmware will not be updated if the target model does not match.
- Do not change the data (folder and file name) downloaded from the Mitsubishi Electric FA website.
- Before executing the firmware update, enable the CPU module reset setting. ( Page 119 Enabling remote RESET) If the update without enabling the reset setting was performed, do not turn the CPU module power OFF and ON or reset the module, and re-execute the update after enabling the reset setting.
- Update the firmware after confirming that the intelligent module to be updated is normally running.
- Update the firmware after confirming that the function using the intelligent module and SD memory card has stopped.
- Update the firmware after confirming that other systems connected on the network have stopped. Communication with other systems may be stopped.
- Back up the various data such as the programs and parameters before executing the firmware update.
- Do not turn the power OFF or reset the CPU module while the firmware update is in progress.
- Do not remove the SD memory card while the firmware update is in progress. If the SD memory card is removed before the firmware update finishes, the process may end with an error.
- If the automatic reset is disabled, manually turn the power OFF and ON after the completion of the update.
- If the system malfunctions after the completion of the firmware update, downgrade the firmware to the previous version. If your version is not found on the Mitsubishi Electric FA website, please consult your local Mitsubishi representative.
- If any of the following operations is performed during the period from the start to the end of the firmware update, the firmware update may terminate abnormally, or the module may be damaged.
 - Turning OFF the power to the system under firmware update, or resetting the system
 - Remotely operating from the engineering tool, or changing the operation status with the CPU module switch
 - Removing the SD memory card
 - Operating the system under firmware update from an external device
 - Connecting/disconnecting the communication cable connecting the CPU module and engineering tool
 - Connecting/disconnecting the module under firmware update
 - Operating the engineering tool to start the firmware update
 - Shutting down the engineering tool

Troubleshooting

If an error occurs, take corrective action according to the error code. (☞ Page 473 List of error codes)

If the error cannot be judged by the error code, check the following items and troubleshoot the situation.

Error details	Action
The firmware update function screen is not displayed.	<ul style="list-style-type: none"> • Check that the communication route is connected to the built-in port of the CPU module (Ethernet (Ethernet port direct connection/connection via hub)), and re-execute the update. • Check whether the firmware version of the CPU module is compatible with the update using the engineering tool. If the CPU module is not compatible, update the CPU module via an SD memory card.
The update file cannot be set.	Check that the firmware update file downloaded from the Mitsubishi Electric FA website has been selected, and re-execute the update.
The update is not performed even when [Update] is pressed, and an error message dialog is displayed.	<ul style="list-style-type: none"> • Check that the firmware update is not prohibited, and re-execute the update. • Check whether or not the firmware update file of the CPU module or any intelligent module remains in the "\$MELPRJ\$" folder in the SD memory card. If there is an unnecessary firmware update file, delete the file. • Check that the SD memory card is inserted in the CPU module. • Check that the version of the firmware update file is not the same as the firmware version of the module to be updated. • Check that the remote reset setting is "Enable," and re-execute the update. • Check that the firmware update file downloaded from the Mitsubishi Electric FA website has been selected, and re-execute the update.
An SD memory card error occurs during execution of the firmware update.	<ul style="list-style-type: none"> • Re-insert the SD memory card, and re-execute the update. • Check that the SD memory card is not write-protected, and re-execute the update. • Format the SD memory card, and re-execute the update. <p>If the same error still occurs after the above actions are taken, the SD memory card may have a hardware error. Replace the SD memory card.</p>
The error code 1910H occurs during execution of the firmware update.	<ul style="list-style-type: none"> • Check whether or not the firmware update file of the CPU module or any intelligent module not to be updated remains in the "\$MELPRJ\$" folder in the SD memory card. If there is an unnecessary firmware update file, delete the file. • Format the SD memory card, and re-execute the update.
The error code 1911H occurs during execution of the firmware update.	Check that the specified intelligent module is correctly inserted, and re-execute the update.
The error code 3040H occurs during execution of the firmware update.	<ul style="list-style-type: none"> • To execute the firmware update, an intelligent module compatible with the new version is required. Please consult your local Mitsubishi representative. • Check that the selected firmware update file matches the model of the module to be updated.
The error code 3041H or 3042H occurs during execution of the firmware update.	Check that the firmware update file downloaded from the Mitsubishi Electric FA website has been selected, and re-execute the update.
A communication timeout occurs during execution of the firmware update.	<p>A communication timeout or a cable trouble may have occurred, or the PLC power is OFF or reset. Execute the following operations.</p> <ol style="list-style-type: none"> (1) Turn the CPU module power OFF and ON, and wait until the ERR LED and RUN LED flash. If the LEDs do not flash after 60 seconds, re-execute the firmware update. (2) Turn the CPU module power OFF and ON again, and wait until the ERR LED and RUN LED turn off. After this, turn the CPU module power OFF and ON again. Then, the firmware update will be completed, and the module will start normally. If the ERR LED flashes and the RUN LED turns off, turn the CPU module power OFF and ON again. <p>In the following cases, the intelligent module may have a hardware error. Please consult your local Mitsubishi representative.</p> <ul style="list-style-type: none"> • When the ERR LED flashes and the RUN LED turns off even after the CPU module power is turned OFF and ON twice in the case where the ERR LED flashes and the RUN LED turns off in (2) • When the RUN LED does not turn off after 60 seconds in (2)
The firmware update is completed abnormally.	Intelligent module may have a hardware error, so please consult your local Mitsubishi representative.

6 SCAN MONITORING FUNCTION

This function detects CPU module hardware or program errors by monitoring the scan time. Using the watchdog timer, which is an internal timer in the CPU module, the following scans are monitored.

- Initial scan (1st scan)
- 2nd scan and after

6.1 Scan time monitoring time setting

Sets the scan time monitoring time.

Navigation window ⇒ [Parameter] ⇒ [FX5UJCPU] or [FX5UCPU] ⇒ [CPU Parameter] ⇒ "RAS Setting" ⇒ "Scan Time Monitoring Time (WDT) Setting"

Window

Item	Setting
Scan Time Monitoring Time (WDT) Setting	
Initial Scan	2000 ms
After 2nd Scan	200 ms

Displayed items

Item	Description	Setting range	Default
Initial Scan	Sets the scan-time monitoring time (WDT) for the initial scan (first scan).	10 to 2000 ms (10 ms units)	2000 ms
After 2nd Scan	Sets the scan-time monitoring time (WDT) for the second and later scans.	10 to 2000 ms (10 ms units)	200 ms

6.2 Resetting of the watchdog timer

Resets the watchdog timer when the END/FEND instruction is executed. When the CPU module operates normally and executes the END/FEND instruction within the watchdog timer setting, the time of the watchdog timer will not time up. If the END/FEND instruction cannot be executed within the watchdog timer setting due to increased program execution as a result of hardware error or interrupt in the CPU module, the time of the watchdog timer will time up.

6.3 Precautions

The following precautions relate to the scan monitoring function.

Watchdog timer reset when executing a program repeatedly

The watchdog timer can be reset by executing the WDT instruction in a program. If the time of the watchdog timer is up while executing a program repeatedly by the FOR instruction and NEXT instruction, use the WDT instruction to reset the watchdog timer.

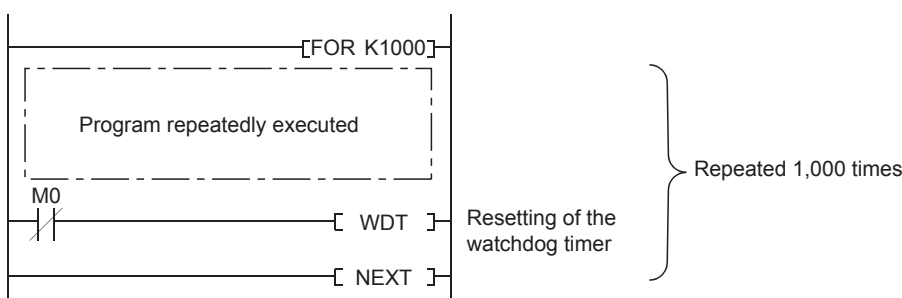

Scan time when the WDT instruction is used

Even though the watchdog timer is reset using the WDT instruction, the scan time value is not reset. The scan timer value is the value measured up to the END instruction.

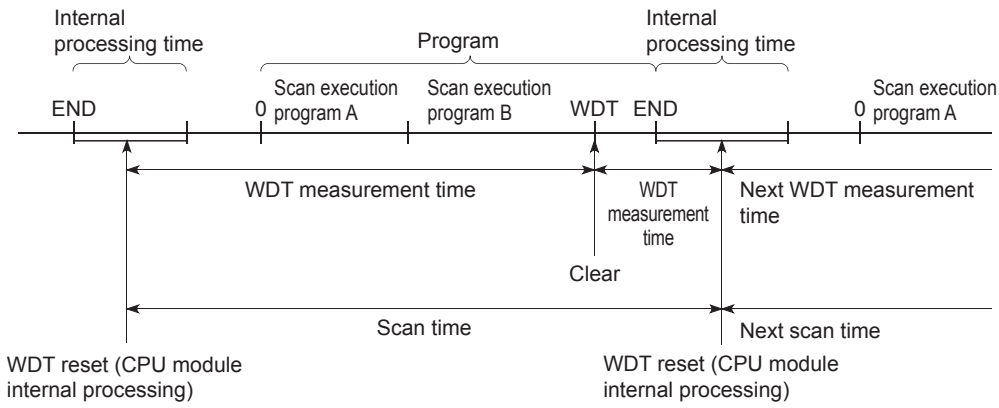

7 CLOCK FUNCTION

The CPU module has an internal clock and is used to manage time in functions performed by the system such as dates of the event history function and the data logging function.

7.1 Time Setting

Time operation continues with the large internal capacitor in the CPU module even though the power in the CPU module is turned OFF or the power failure exceeds the allowable momentary power failure time.

If an optional battery is used in the FX5U/FX5UC CPU module, operation continues by the battery.

Clock data

The clock data handled in the CPU unit is described below.

Data name	Description
Year	4 digits in calendar year (1980 to 2079)
Month	1 to 12
Day	1 to 31 (Leap year auto detect)
Hour	0 to 23 (24-hour system)
Minute	0 to 59
Second	0 to 59
Day-of-the-week	0: Sunday, 1: Monday, 2: Tuesday, 3: Wednesday, 4: Thursday, 5: Friday, 6: Saturday

Changing the clock data

The clock data can be changed using the following methods.

- Using engineering tools
- Using SM/SD
- Using instructions

Using the engineering tool

Clock data can be changed using Set Clock from the menu. ([GX Works3 Operating Manual](#))

Using SM/SD

The values stored in SD210 (clock data) to SD216 (clock data) are written to the CPU module after END processing execution of scan when SM210 (clock data set request) is changed from OFF→ON. If the data from SD210 to SD216 is out of the valid range, SM211 (clock data set error) is turned ON, the values from SD210 to SD216 are not written in the CPU module.

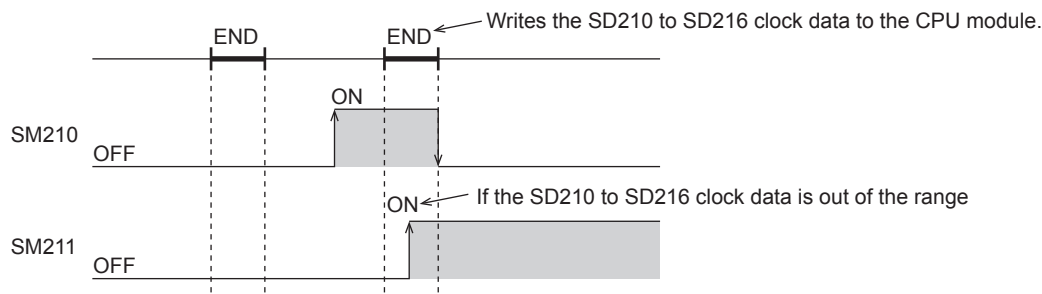

Using instructions

Writes the clock data to the CPU module, using the TWR(P) instruction. ([MELSEC iQ-F FX5 Programming Manual \(Instructions, Standard Functions/Function Blocks\)](#))

Reading clock data

There are the following methods to read clock data.

- Using SM/SD
- Using instructions

Using SM/SD

Clock data is read to SD210 to SD216 when SM213 (clock data read request) is turned ON.

Using instructions

Clock data is read from the CPU module using the TRD(P) instruction. ( MELSEC iQ-F FX5 Programming Manual (Instructions, Standard Functions/Function Blocks))

Precautions

The following describes precautions when setting the time.

When setting the clock for the first time

The clock is not set when the product is shipped.

Correcting the clock data

Before correcting any part of the clock data, you must write all data into the CPU module again.

7.2 Setting Time Zone

The time zone used for the CPU module can be specified. Specifying the time zone enables the clock of the CPU module to work in the local time zone.

Navigation window ⇒ [Parameter] ⇒ [FX5UJCPU] or [FX5UCPU] ⇒ [CPU Parameter] ⇒ "Operation Related Setting" ⇒ "Clock Related Setting"

Window

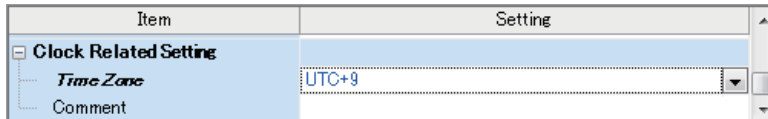

Displayed items

Item	Description	Setting range	Default
Time Zone	Sets the time zone used by the CPU module.	<ul style="list-style-type: none"> • UTC+13 • UTC+12 • UTC+11 • UTC+10 • UTC+9:30 • UTC+9 • UTC+8 • UTC+7 • UTC+6:30 • UTC+6 • UTC+5:45 • UTC+5:30 • UTC+5 • UTC+4:30 • UTC+4 • UTC+3:30 • UTC+3 • UTC+2 • UTC+1 • UTC • UTC-1 • UTC-2 • UTC-3 • UTC-3:30 • UTC-4 • UTC-4:30 • UTC-5 • UTC-6 • UTC-7 • UTC-8 • UTC-9 • UTC-10 • UTC-11 • UTC-12 	UTC+9
Comment	Enters a comment for the time zone (e.g., name of the city).	1 to 32 letters	—

Point

To reflect the time zone setting on the CPU module, the module must be restarted. If no parameter is set for the CPU module (factory setting), it operates with "UTC+9".

7.3 System clock

There are two types of system clocks, one is to execute ON/OFF by the system and the other is to execute ON/OFF in the intervals specified by the user.

Special relay used for system clock

Special relays used for system clock are as follows.

Special relay	Name
SM400, SM8000	Always ON
SM401, SM8001	Always OFF
SM402, SM8002	After RUN, ON for one scan only
SM403, SM8003	After RUN, OFF for one scan only
SM409, SM8011	0.01 second clock
SM410, SM8012	0.1 second clock
SM411	0.2 second clock
SM412, SM8013	1 second clock
SM413	2 second clock
SM414	2n second clock
SM415	2n ms clock
SM8014	1 min clock
SM420, SM8330	Timing clock output 1
SM421, SM8331	Timing clock output 2
SM422, SM8332	Timing clock output 3
SM423, SM8333	Timing clock output 4
SM424, SM8334	Timing clock output 5

7

Special register used for system clock

Special registers used for system clock are as follows.

Special register	Name
SD412	One second counter
SD414	2n second clock setting
SD415	2n ms clock setting
SD420	Scan counter
SD8330	Counted number of scans for timing clock output 1
SD8331	Counted number of scans for timing clock output 2
SD8332	Counted number of scans for timing clock output 3
SD8333	Counted number of scans for timing clock output 4
SD8334	Counted number of scans for timing clock output 5

Point

SM420 to SM424, SM8330 to SM8334, and SD8330 to SD8334 are used by the DUTY instruction. For the DUTY instruction, refer to the following.

 MELSEC iQ-F FX5 Programming Manual (Instructions, Standard Functions/Function Blocks)

8 ONLINE CHANGE

This chapter describes online change.

8.1 Online Ladder Block Change

Writes the portion edited on the ladder edit window of the engineering tool to the CPU module in increments of ladders. Edited contents spanning multiple files or multiple portions can be written to the CPU module at once.

Point

For details on the operating procedure of online ladder block change on engineering tools, refer to the following.

 GX Works3 Operating Manual

Editable contents

Within a program block, instructions and pointers (P, I) can be added, changed, or deleted. Also, as POU unit, program blocks can be added, changed, or deleted. However, when the program/FB file is not in agreement between engineering tool and a CPU module, it cannot be added, changed, or deleted.

Range changeable in a single session

The following shows the number of steps and number of ladder blocks which can be changed in a single session.

- Number of ladder blocks in a file: 64 blocks or less (32767 steps or less)
- The total of the changed circuit block count in all files: 256 blocks or less
- The total capacity of the program file and the FB file after a change: 1 M byte or less
- The total capacity of the target data for online change: 192 K byte or less

Online ladder block change during the boot operation

If online change of ladder block is executed from the SD memory card during boot operation, the corresponding file in the SD memory card, which is the boot source, can be changed as well.

Precautions

This section describes the precautions on using online ladder block change.

Online change to SFC program

Online change to the SFC program cannot be performed. However, online change to the other programs which coexist with the SFC program (such as the ladder program) can be performed.

Prohibited operation at online ladder block change

When an online change of ladder block, if the power is turned OFF or a reset is made, the process does not end normally. Such operation is made, execute rewriting to the PLC.

When deleting OUT instruction which is on

When deleting an OUT instruction (coil) which is not necessary for control, be sure to check that the OUT instruction is off before deleting it. If the OUT instruction is deleted without turning it off in advance, the output will be retained.

Program file not registered in program setting

A program file which is not registered in parameter setting cannot be written.

Initializing the last execution if the ladder at online ladder block change has an FB call

- If a subroutine type FB is called in a FB definition, the execution information of the previous time in the FB definition of the subroutine type FB is not initialized.
- If a macro type FB is called in the FB definition of a subroutine type, the execution information of the previous time in the part equivalent to the macro type FB is not initialized either.

Instructions not compatible with online ladder block change

Do not execute online change to ladder block including the following instruction.

DSZR/DDSZR instruction, DVIT/DDVIT instruction, TBL instruction, DRVTBL instruction, PLSV/DPLSV instruction, DRVI/DDRVI instruction, DRVA/DDRVA instruction, DRVMUL instruction, PLSY/DPLSV instruction, PWM/DPWM instruction, SPD/DSPD instruction, HIOEN/DHIOEN instruction, UDCNTF instruction, DABS instruction, ADPRW instruction, IVCK instruction, IVDR instruction, IVRD instruction, IVWR instruction, IVBWR instruction, IVMC instruction, S(P).CPRTCL instruction, RS2 instruction, SP.SOCOPEN instruction, SP.SOCCLOSE instruction, SP.SOCSND instruction, SP.SOCRCV instruction, SP.ECPRTCL instruction, RBFM instruction, WBFM instruction

The cautions at the time of repeatedly performing online change

When online change is performed repeatedly, RUN writing may not be able to be carried out due to insufficient memory in the CPU module. Please set the CPU module to STOP and write the program.

The size of the target data at online change

When the size of the target data of online change exceeds 192 K bytes, online change fails and an error message is displayed on the engineering tool. The target data size may exceed 192 K bytes in the following cases:

- When the capacity of the edited program file exceeds 192 K byte
- When the total capacity of multiple edited program files exceeds 192 K byte

In the above mentioned cases, divide the program file in advance to reduce each file size, avoid performing online change to multiple program files at once (divide the files and perform online change several times), or take other actions.*1

*1 Usually, online change is performed to only edited files. However, in the following cases, online change is performed to a file other than the edited file.

- When a global label or structure is changed, the program using the changed global label and structure is a target of online change.
- When FB or FUN is changed, the program using the changed FB and FUN is a target of online change.

For confirmation of the target file for online change and the file capacity, refer to the following.

 GX Works3 Operating Manual

Separate writing of a program and program restoration information

When writing data to a CPU module by using the online program change function, a program and program restoration information can separately be written by setting "Yes" for the following option.

 [Tool] ⇒ [Options] ⇒ "Convert" ⇒ "Online Program Change" ⇒ "Operational Setting" ⇒ "Divide to Write a Program and Program Restore Information"

By writing a program and program restoration information separately, an error that occurs when the capacity of data to be written to a CPU module exceeds the maximum writable capacity may be cleared.

For supported version of separate writing of a program and program restoration information, refer to  Page 566 Added and Enhanced Functions.

Precautions

- It may take time to write data when writing a program and program restoration information separately.
- A project is automatically saved with the data writing. Therefore, it is necessary to register the project history in advance.
- If a project is not saved automatically, the data will also not be written to a CPU module.
- When writing fails, reset or cycle the power of the CPU module. Then, write the data to the CPU module in the STOP state.

The operation when a pulse type instruction is included in the range of an online ladder block change

The operation when a pulse related instruction is included in the range of an online ladder block change is as follows.

Pulse type instruction	Description
Rising instruction (PLS and □P instructions)	When a rising instruction exists within the range to be changed, the rising instruction will not be executed if the execution condition (OFF to ON) is fulfilled at completion of online program change.
Falling instruction (PLF and □F instructions)	When a falling instruction exists within the range to be changed, the falling instruction will not be executed even if the execution condition (ON to OFF) is fulfilled at completion of online program change.

■Rising instruction

When a rising instruction exists within the range to be changed, the rising instruction will not be executed if the execution condition (OFF to ON) is fulfilled at completion of online program change.

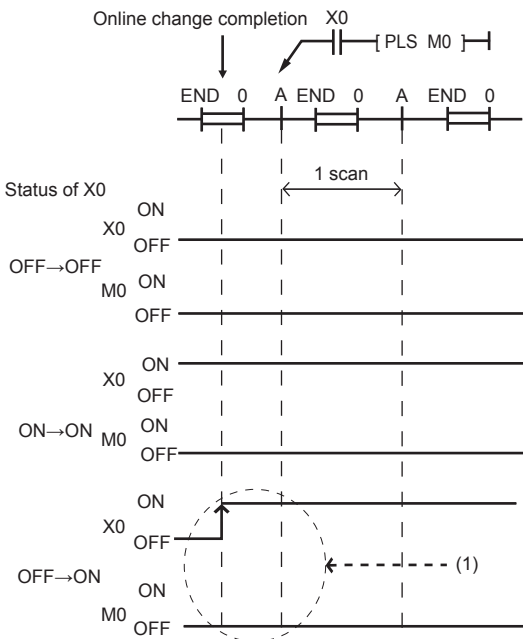

(1) The rising instruction will not be executed even if the execution condition is OFF to ON.

■Falling instruction

When a falling instruction exists within the range to be changed, the falling instruction will not be executed even if the execution condition (ON to OFF) is fulfilled at completion of online program change.

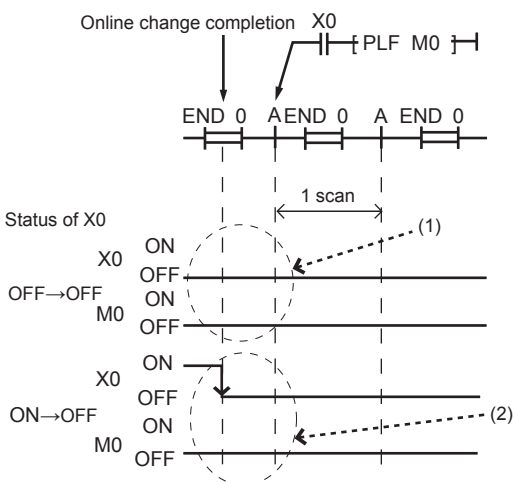

(1) The falling instruction will not be executed even if the execution condition is OFF to OFF.

(2) If online program change and transition of ON to OFF occur simultaneously, the falling instruction will not be executed.

Online change (ladder block) when another function is performed

Online ladder block change cannot be executed while executing the backup/restoration function. (☞ Page 199 DATA BACKUP/RESTORATION FUNCTION) Confirm that the backup/restoration function is not being executed before executing the online ladder block change.

9 INTERRUPT FUNCTION

This chapter describes the interrupt function.

9.1 Multiple Interrupt Function

When an interrupt occurs while an interrupt program triggered by another cause is running, stops the program if its priority is lower than that of the new interrupt, and runs the higher-priority program whenever its execution condition is satisfied.

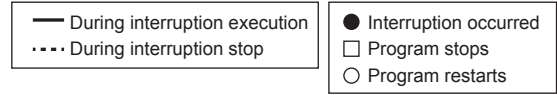

• When the multiple interruption function is enabled

[Priority]

- I10: High
- I0: Low

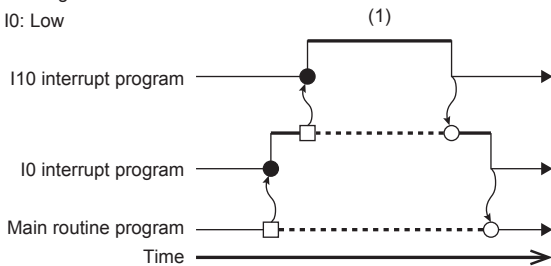

• When not set (at default)

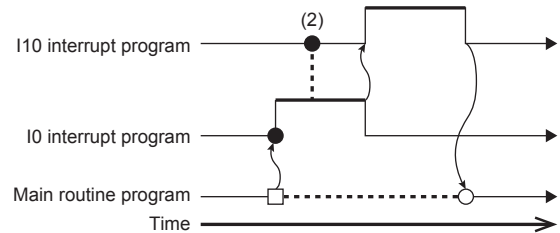

(1) A high-priority interrupt is executed by interrupting a low-priority interrupt.

(2) Even if a high-priority interrupt occurs, it enters the waiting status until the executing interrupt is completed.

Precautions

A watchdog timer error may occur under the following conditions.

- When the interrupt frequency is high
- When the interrupt program execution time is long

When a watchdog timer error occurs, review the call frequency and execution time of the interrupt program.

Interrupt priority

If the interrupt priority of a program for which its execution condition has been satisfied is higher than that of the running program, the programs are executed in accordance with their interrupt priority. If the interrupt priority of the new program is the same or lower, it enters the waiting status until the running program finishes. (Page 370 The priority for the interrupt pointer numbers and interrupt factors)

Interrupt priority setting

The interrupt priority (1 to 3) of interruptions from modules can be changed.

Navigation window ⇒ [Parameter] ⇒ [FX5UJCPU] or [FX5UCPU] ⇒ [CPU Parameter] ⇒ "Interrupt Settings" ⇒ "Interrupt Priority Setting from Module"

Operating procedure

"Interrupt Settings" window

Item	Setting
Interrupt Priority Setting from Module	
Multiple Interrupt	Enable
Interrupt Priority	<Detailed Setting>

"Detailed Setting" window

Interrupt Pointer	Priority
I0	2
I1	2
I2	2
I3	2
I4	2
I5	2
I6	2
I7	2
I8	2
I9	2
I10	2
I11	2
I12	2
I13	2
I14	2
I15	2

1. Set Multiple Interrupt to "Enable" on the "Interrupt Settings" window, and click "Detailed Setting".
2. Change the priority of each interrupt pointer.

Displayed items

Item	Description	Setting range	Default	
Multiple Interrupt	Sets whether or not to enable multiple interrupt.	<ul style="list-style-type: none"> • Disable • Enable 	Disable	
Interrupt Priority	Detailed Setting	Sets the priority of the interrupt pointers I0 to I23, I28 to I31, and I50 to I177.	1 to 3 ^{*1}	2

*1 The lower the numerical value, the higher the interrupt priority.

Disabling/enabling interrupts with a specified or lower priority

Interrupts with a priority equal or lower than that specified by the DI or EI instruction can be disabled or enabled even when multiple interrupts are present.

For details, refer to MELSEC iQ-F FX5 Programming Manual (Instructions, Standard Functions/Function Blocks).

Point

Disabled interrupt priorities and the current interrupt priority can be checked in SD758 (Interrupt disabling for each priority setting value) and SD757 (Current interrupt priority) respectively.

10 PID CONTROL FUNCTION

10.1 Outline of Function

PID control is performed by PID control instruction. The PID instruction requires the system to calculate the output (MV) value from the measured (PV) value. Through combining the P (proportional) action, I (integral) action, and D (derivative) action the target (SV) value can be obtained.

- Alarm output function

The alarm function can be set for input variation (measured value) or output variation (value).

- Setting limit values

The upper limit and lower limit can be set for the output value.

- Auto-tuning function

The proportional gain (KP), integral time (TI) and differential time (TD) can be set automatically for both the limit cycle method and step response method.

- Operation method of the PID instruction

Both PID speed type operation and measured value differential type operation are executed.

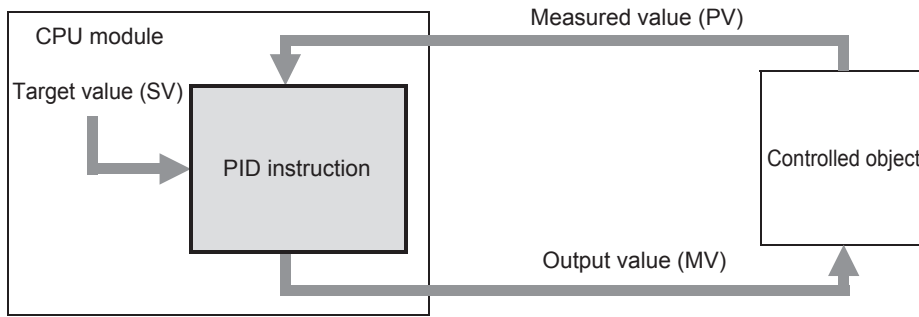

10.2 Basic Operation Expressions in PID Instruction

The PID instruction executes using the speed type or measured value differential type operation expression. According to the contents of (s3)+1, bit 0 (operation setting (ACT)) specified by (s3) in the PID control, either forward operation or backward operation is executed. Each value required in the operation is specified by a corresponding parameter (s3) or later.

Basic operation expression for PID control

Operation setting (ACT) (s3+1: b0)	Operation expression	The meaning of the signs
Forward operation (OFF)	$\Delta MV = KP \left\{ (EV_n - EV_{n-1}) + \frac{TS}{TI} EV_n + D_n \right\}$ $EV_n = PV_{nf} - SV$ $D_n = \frac{TD}{TS + KD \cdot TD} (-2PV_{nf-1} + PV_{nf} + PV_{nf-2}) + \frac{KD \cdot TD}{TS + KD \cdot TD} \cdot D_{n-1}$ $MV_n = \sum \Delta MV$	EV _n : Deviation in sampling at this time EV _{n-1} : Deviation in previous cycle SV: Target value PV _{nf} : Measured value in sampling at this time (after filter) PV _{nf-1} : Measured value in previous cycle (after filter) PV _{nf-2} : Measured value in two cycles before (after filter)
Backward operation (ON)	$\Delta MV = KP \left\{ (EV_n - EV_{n-1}) + \frac{TS}{TI} EV_n + D_n \right\}$ $EV_n = SV - PV_{nf}$ $D_n = \frac{TD}{TS + KD \cdot TD} (2PV_{nf-1} - PV_{nf} - PV_{nf-2}) + \frac{KD \cdot TD}{TS + KD \cdot TD} \cdot D_{n-1}$ $MV_n = \sum \Delta MV$	ΔMV: Output variation MV _n : Operation quantity at this time D _n : Differential term at this time D _{n-1} : Differential term in previous cycle TS: Sampling cycle KP: Proportional gain TI: Integral constant TD: Differential constant KD: Differential gain

Expression for calculating the measured value (after the filter) in sampling at this time (PV_{nf})

The value "PV_{nf}" is obtained from the following expression based on the read measured value.

Measured value after filter: $PV_{nf} = PV_n + L (PV_{nf-1} - PV_n)$

PV_n: Measured value in sampling at this time

L: Filter coefficient

PV_{nf-1}: Measured value in previous cycle (after filter)

10.3 How to Use PID Instruction

This instruction executes PID control which changes the output value according to the input variation. For details on the PID instruction, refer to the following manual.

MELSEC iQ-F FX5 Programming Manual (Instructions, Standard Functions/Function Blocks)

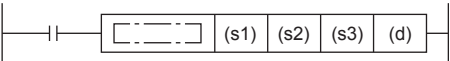
Ladder diagram	Structured text
	<pre>ENO:=PID(EN,s1,s2,s3,d);</pre>

FBD/LD

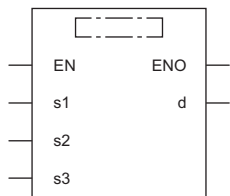

Setting data

■ Descriptions, ranges, and data types

Operand	Description	Range	Data type	Data type (label)
(s1)	Device number storing the target value (SV)	-32768 to +32767	16-bit signed binary	ANY16 ^{*1}
(s2)	Device number storing the measured value (PV)	-32768 to +32767	16-bit signed binary	ANY16 ^{*1}
(s3)	Device number storing PID parameters	1 to 32767	16-bit signed binary	ANY16 ^{*1}
(d)	Device number storing the output value (MV)	-32768 to +32767	16-bit signed binary	ANY16 ^{*1}
EN	Execution condition	—	Bit	BOOL
ENO	Execution result	—	Bit	BOOL

*1 When setting using a label, use the global label assigned to the device.

■ Applicable devices

Operand	Bit	Word			Double word		Indirect specification	Constant			Others
	X, Y, M, L, SM, F, B, SB, S	T, ST, C, D, W, SD, SW, R	U□\G□	Z	LC	LZ		K, H	E	\$	
(s1)	—	○ ^{*1}	○	—	—	—	—	—	—	—	—
(s2)	—	○ ^{*1}	○	—	—	—	—	—	—	—	—
(s3)	—	○ ^{*1}	—	—	—	—	—	—	—	—	—
(d)	—	○ ^{*1}	○	—	—	—	—	—	—	—	—

*1 Only D, SD, R can be used.

Processing details

- Once the target value (s1), measured value (s2) and PID parameters (s3) to (s3)+6 are set and the program is executed, the operation result (MV) is transferred to the output value (d) at every sampling time. The sampling time is specified by (s3).

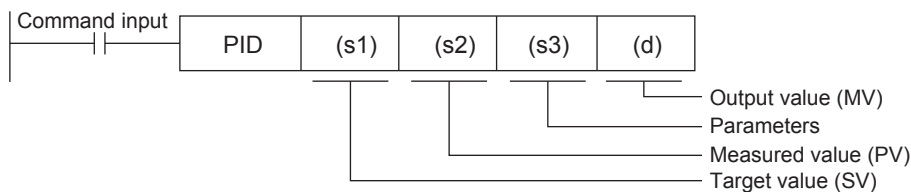

■Set item

Set item	Description	Occupied points
(s1)	Target value (SV) The target value (SV) is set. The PID instruction does not change the settings. [Caution on using the auto-tuning (limit cycle method)] If the target value for auto-tuning is different from the target value in the PID control, it is necessary to set a value to which a bias value is added, and then store the actual target value when the auto-tuning flag turns OFF.	1 point
(s2)	Measured value (PV) This is the input value of the PID operation. It is necessary to read a normal measurement data before the execution of the PID operation for the measurement value of PID (PV). If an input value from an analog input is used for the PID operation, use caution to its conversion time.	1 point
(s3)	Parameter PID control 25 devices are occupied from the head device specified in (s3)	25 points
	Auto-tuning: In the limit cycle 29 devices are occupied from the head device specified in (s3)	29 points
	Auto-tuning: In the step response method ((s3)+1: b8 is set to OFF) 25 devices are occupied from the head device specified in (s3)	25 points
	Auto-tuning: In the step response method ((s3)+1: b8 is set to ON) 28 devices are occupied from the head device specified in (s3)	28 points
(d)	Output value (MV) PID control (normal processing) The user sets the initial output value before driving the instruction. After that, the operation result is stored.	1 point
	Auto-tuning: In the limit cycle The Upper Limit Value (ULV) or Lower Limit Value (LLV) value is automatically output during auto-tuning. The specified MV value is output when auto-tuning is finished.	
	Auto-tuning: In the step response method The user sets the step output value before driving the instruction. The MV value is not changed by PID instruction during auto-tuning.	

■Precautions for using the PID instruction

For the precautions for using the PID instruction, refer to the following manual.

📖 MELSEC iQ-F FX5 Programming Manual (Instructions, Standard Functions/Function Blocks)

10.4 Relationship Between Parameter Setting and Auto-Tuning

When auto-tuning is not executed (parameter setting)

It is necessary to write the set value of the parameters (s3) to (s3)+6 using MOV instruction in advance, etc. before starting the PID operation when auto-tuning is not executed. If a device with a latch setting is specified, the setting data is retained even after the power to the CPU module is turned OFF; therefore, the writing at the 2nd power ON is not required.

For details on parameters, refer to  Page 81 Parameter.

When auto-tuning is executed

The proportional gain ((s3)+3), integral time ((s3)+4) and differential time ((s3)+6) are important constants for executing the auto-tuning function described later and for optimizing the PID control. These constants can be set automatically.

For a detailed description of auto-tuning, refer to  Page 93 Auto-Tuning.

10.5 Parameter

Set item	Description/Setting range		Remarks	
(s3)	Sampling time (TS)		1 to 32767 (ms)	It cannot be shorter than operation cycle of the PLC.
(s3)+1	Operation setting (ACT)	b0	0: Forward operation 1: Backward operation	Operation direction
		b1	0: Input variation alarm is invalid 1: Input variation alarm is valid	—
		b2	0: Output variation alarm is invalid 1: Output variation alarm is valid	Do not set b2 and b5 to ON at the same time.
		b3	Not used	—
		b4	0: Auto-tuning is not executed. 1: Auto-tuning is executed	—
		b5	0: Upper and lower limits of output value are not valid 1: Upper and lower limits of output value are valid	Do not set b2 and b5 to ON at the same time.
		b6	0: Step response method 1: Limit cycle method	Select auto-tuning mode.
		b7 ^{*2}	0: Overshoot suppression processing invalid (FX3U compatible) 1: Overshoot suppression processing valid	When b7 is ON, the overshoot suppression processing is performed.
		b8 ^{*2}	0: Without the hunting suppression processing (FX3U compatible) 1: With the hunting suppression processing	This is valid when b4 is ON and b6 is OFF. When b8 is ON, the hunting suppression processing is performed.
	b9 to b15	Not used	—	
(s3)+2	Input filter constant (α)		0 to 99 [%]	When "0" is set, input filter is not provided.
(s3)+3	Proportional gain (KP)		1 to 32767 [%]	—
(s3)+4	Integral time (TI)		0 to 32767 [$\times 100$ ms]	When "0" is set, it is handled as " ∞ " (no integration).
(s3)+5	Differential gain (KD)		0 to 100 [%]	When "0" is set, differential gain is not provided.
(s3)+6	Differential time (TD)		0 to 32767 [$\times 10$ ms]	When "0" is set, differential is not executed.
(s3)+7 to (s3)+19	These devices are occupied for internal processing of PID operation. Do not change data.			
(s3)+20 ^{*1}	Input variation (incremental) alarm set value		0 to 32767	It is valid when operation setting (ACT) (b1 of (s3)+1) is "1".
(s3)+21 ^{*1}	Input variation (decremental) alarm set value		0 to 32767	It is valid when operation setting (ACT) (b1 of (s3)+1) is "1".
(s3)+22 ^{*1}	Output variation (incremental) alarm set value		0 to 32767	It is valid when operation setting (ACT) (b2 of (s3)+1) is "1" and (ACT) (b5 of (s3)+1) is "0".
	Output upper limit set value		-32768 to +32767	It is valid when operation setting (ACT) (b2 of (s3)+1) is "0" and (ACT) (b5 of (s3)+1) is "1".
(s3)+23 ^{*1}	Output variation (decremental) alarm set value		0 to 32767	It is valid when operation setting (ACT) (b2 of (s3)+1) is "1" and (ACT) (b5 of (s3)+1) is "0".
	Output lower limit set value		-32768 to +32767	It is valid when operation setting (ACT) (b2 of (s3)+1) is "0" and (ACT) (b5 of (s3)+1) is "1".
(s3)+24 ^{*1}	Alarm output	b0	0: Input variation (incremental) is not exceeded. 1: Input variation (incremental) is exceeded.	It is valid when operation setting (ACT) (b1 or b2 of (s3)+1) is "1".
		b1	0: Input variation (decremental) is not exceeded. 1: Input variation (decremental) is exceeded.	
		b2	0: Output variation (incremental) is not exceeded. 1: Output variation (incremental) is exceeded.	
		b3	0: Output variation (decremental) is not exceeded. 1: Output variation (decremental) is exceeded.	

Set item	Description/Setting range	Remarks
<p>■The following setting is required when using the limit cycle method (operation setting (ACT) (b6 of (s3)+1) is "1").</p>		
(s3)+25	PV value threshold (hysteresis) width (SHPV)	Set it according to measured value (PV) fluctuation.
(s3)+26	Output value upper limit (ULV)	Set maximum value (ULV) of output value (MV).
(s3)+27	Output value lower limit (LLV)	Set minimum value (LLV) of output value (MV).
(s3)+28	Wait setting from end of tuning cycle to start of PID control (KW)	-50 to +32717 [%]
<p>■The following setting is required when using the timeout time after maximum ramp (operation setting (ACT) (b6 of (s3)+1) is "0" and (ACT) (b8 of (s3)+1) is "1") with the step response method.</p>		
(s3)+25	Timeout time setting value after maximum ramp (R) detection	1 to 32767 [s]
(s3)+26 (s3)+27	These devices are occupied for internal processing of PID operation. Do not change data.	

*1 (s3)+20 to +24 become used only if b1, b2, or b5 are set to "1" to determine the action (ACT) (s3) of +1.

*2 For supported version of each setting, refer to  Page 566 Added and Enhanced Functions.

10.6 Details of Parameters

This chapter describes the details of parameters.

Sampling time (s3)

Set the cycle time (ms) for the PID operation. Setting range: 1 to 32767 (ms)

- In PID control and auto-tuning (Limit cycle method)

Set the sampling time longer than the operation cycle of the PLC.

- In auto-tuning (Step response method)

Set the sampling time to 1000 ms (= 1 second) or more.

Maximum error

The maximum error of the sampling time (TS) is from "- (one operation cycle+1 ms)" to "+ (one operation cycle)."

- When the sampling time (TS) is a small value

Fluctuation of the maximum error described above may cause a problem. In such a case, execute the PID instruction in the constant scan mode, or program it in a timer interrupt routine.

- When the sampling time (TS) is shorter than one operation cycle of the PLC

A PID operation error occurs, however when PID operation is executed, the sampling time (TS) is equal to the operation cycle of the PLC. In such a case, use the PID instruction in a timer interrupt, and clear (s3)+7 just before executing the PID instruction.

Operation setting (s3)+1

Forward operation/backward operation

Set the PID control direction (forward or backward).

- During auto-tuning for the limit cycle method

It is necessary to set the PID control direction (forward or backward) for auto-tuning.

- During auto-tuning for the step response method

The PID control direction (forward or backward) is not required, as the direction is automatically set when auto-tuning is complete.

Operation setting (s3)+1: b0		Operation
Forward operation (b0=OFF)	As the measured value (PV) becomes larger than the target value (SV), the output (MV) increases. For example, cooling is a forward operation.	
Backward operation (b0=ON)	As the measured value (PV) becomes smaller than the target value (SV), the output (MV) increases. For example, heating is a backward operation.	

- Relationship between the forward/backward operation and the output (MV), measured value (PV) and target value (SV)
The relationship is as follows.

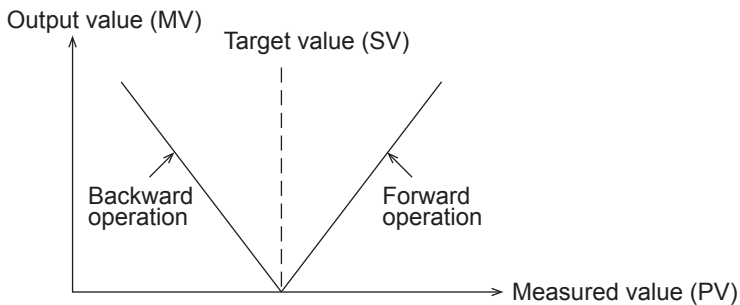

Alarm setting (for input variation and output variation)

If b1 and b2 in (s3) +1 are turned ON, the input variation and the output variation can be checked. The check is executed by following the values of (s3) +20 to (s3) +23.

These parameters can be set in (s3)+24.

For details on operation of alarm output, refer to  Page 92 Alarm output (s3)+24.

- Input variation

If the input variation alarm is used, turn ON b1 in (s3) +1, and specify the input variation alarm set value.

Set item			Setting description/Setting range
Operation setting	(s3)+1: b1	Input variation alarm	ON: Used OFF: Not used
Input variation alarm set value	(s3)+20	Input variation (incremental) alarm set value	0 to 32767
	(s3)+21	Input variation (decremental) alarm set value	0 to 32767

- Output variation

If the output variation alarm is used, turn ON b1 in (s3) +1, and specify the output variation alarm set value.

When this function is used, make sure to turn OFF b5 of (s3) +1.

Set item			Setting description/Setting range
Operation setting	(s3)+1: b2	Output variation alarm	ON: Used OFF: Not used
	(s3)+1: b5	Output value upper/lower limit setting	Make sure to set it to OFF
Output variation alarm set value	(s3)+22	Output variation (incremental) alarm set value	0 to 32767
	(s3)+23	Output variation (decremental) alarm set value	0 to 32767

Point

Variation means (Current value) - (Previous value)

Upper and lower limits for output value

When the upper and lower limit settings of the output value are valid, the output value is as shown in the chart. The upper limit and lower limit of the output value can moderate the increase of the integral item in the PID control.

When using the upper limit and lower limit of the output value, make sure to set (s3)+1, b2 to OFF.

Set item			Setting description/Setting range
Operation setting	(s3)+1: b2	Output variation alarm	Make sure to set it to OFF
	(s3)+1: b5	Output value upper/lower limit setting	ON: Used OFF: Not used

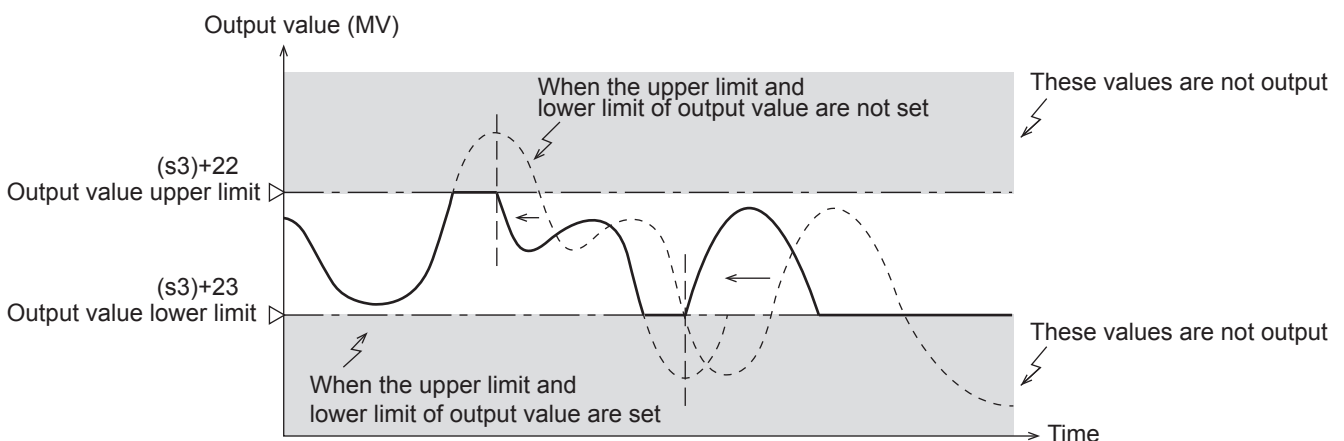

Overshoot suppression setting

Set the overshoot suppression processing. Especially, when the difference between the target value and current value is big, turn b7 of (s3)+1 ON. It is effective to suppress the overshoot during PID control operation.

Set item		Setting description/Setting range	
Operation setting	(s3)+1: b7	Overshoot suppression setting	ON: Used OFF: Not used

Temperature

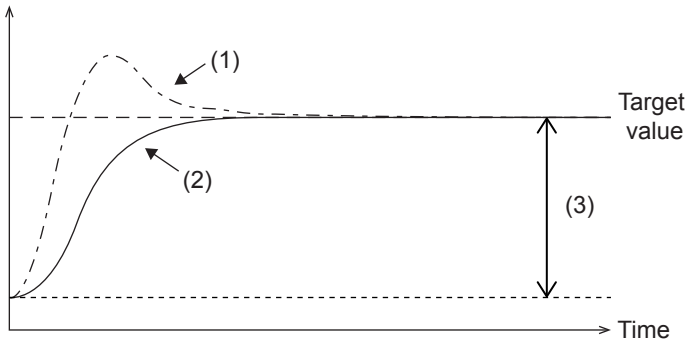

- (1) Overshoot suppression setting invalid
- (2) Overshoot suppression setting valid
- (3) If overshoot suppression setting is invalid, the first output variation ΔMV is determined by this difference.

If the output variation rate ΔMV is large during the initial scan time, the output will be suppressed in the following manner.

Output value (MV)

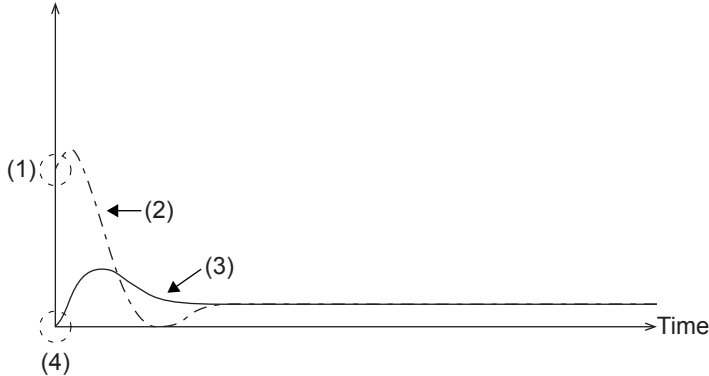

- (1) Initial output value is large
- (2) Overshoot suppression setting invalid
- (3) Overshoot suppression setting valid
- (4) The output variation rate is forcibly set to 0, so the initial output value will be 0. (When offset value offset is 0)

Point

If the overshoot suppression setting is not used, the PID control operation with similar performance to the FX3 PLC will be executed.

Hunting suppression setting

Especially, if the step response method auto-tuning (Page 93 Auto-Tuning) is executed in an environment where the measurement value varies temporarily because of noise of the sensor and analog input, auto-tuning may be not executed correctly and hunting may occur during PID control operation.

When b8 of (s3)+1 is turned ON and the current input value is less than the previous input value temporarily, auto-tuning is not completed until the set timeout time has elapsed. Therefore, maximum ramp (R) can be obtained correctly. (See the figure below.)

To use this function, turn ON b4 of (s3)+1 and OFF b6 of (s3)+1.

Set item		Setting description/Setting range	
Operation setting	(s3)+1: b4	Auto-tuning	Make sure to set it to ON
	(s3)+1: b6	Auto-tuning mode	Make sure to set it to OFF
	(s3)+1: b8	Hunting suppression setting	ON: Used OFF: Not used
	(s3)+25	Timeout time setting value after maximum ramp (R) detection	1 to 32767

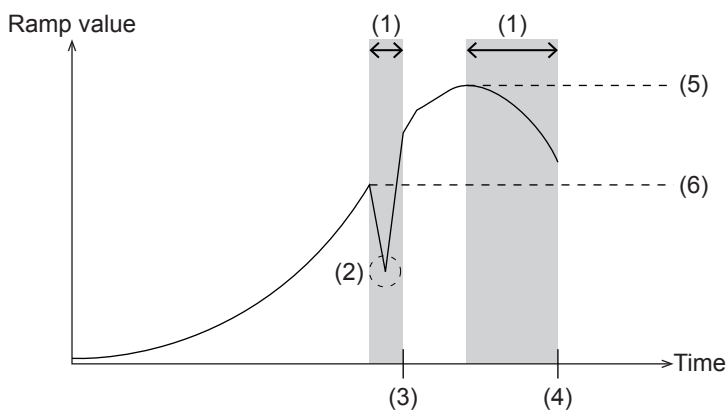

- (1) Timeout wait after maximum ramp detection
- (2) A decrease of ramp caused by temporary deviation of the input value
- (3) Maximum ramp (R) is updated so that auto tuning continues
- (4) Timeout wait after maximum ramp detection
- (5) Maximum ramp (R) detection value at the end of auto tuning
- (6) Maximum ramp (R) detection value at the end of auto tuning when this setting is not used

The ramp value is obtained with the following formula.

$$\text{Ramp value} = (\text{current input value} - \text{previous input value}) \div \text{sampling time}$$

Point

If the hunting suppression setting is not used, the PID control operation with similar performance to the FX3 PLC will be executed.

Input filter constant (s3)+2

The input filter (α) is a software filter to reduce the fluctuation of the measured value (PV) caused by noise. By setting this time constant of the filter according to the control target characteristics and noise level, the effect of noise can be reduced. If the input filter value is too small, the filter effect is small. If the input filter value is too large, the input response is bad. Setting range: 0 to 99 (%).

Because the input filter (α) acts on the target value (SV), all of the proportional operation, integral operation and differential operation are affected.

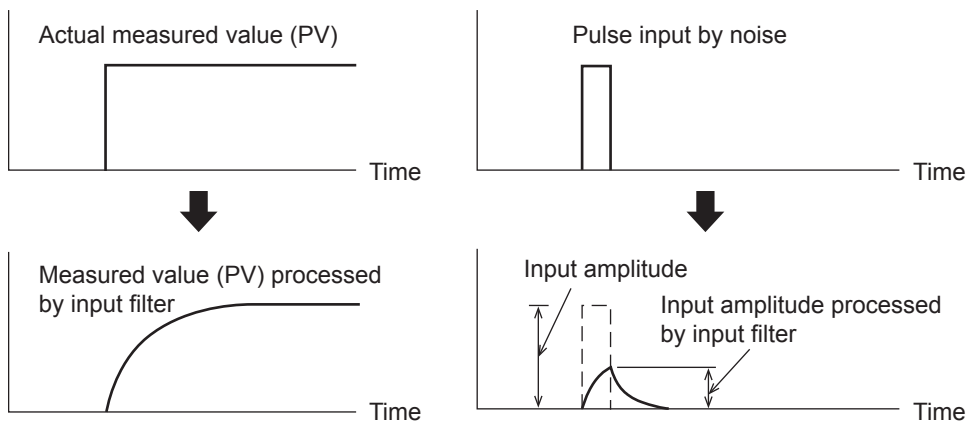

Proportional gain (s3)+3

During the proportional operation, the output (MV) increases in proportion to the deviation (difference between the target value (SV) and the measured value (PV)). This deviation is called proportional gain (Kp), and expressed in the following relational expression:

$$\text{Output (MV)} = \text{Proportional gain (KP)} \times \text{Deviation (EV)}$$

The reciprocal of the proportional gain (KP) is called proportional band. As the proportional gain (KP) is larger (as shown in the example below), the motion to let the measured value (PV) be nearer to the target value (SV) becomes stronger.

Setting range: 1 to 32767 (%)

Ex.

Proportional operation (P operation) in backward operation (heating)

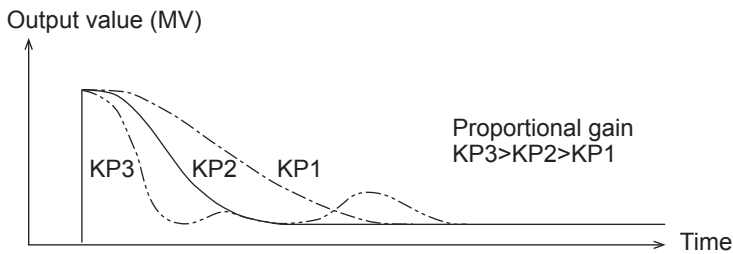
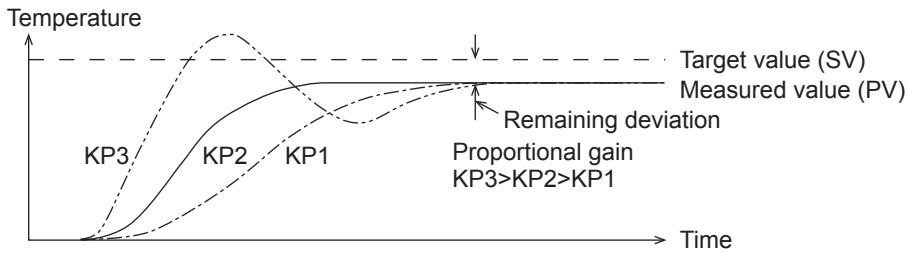

Ex.

Proportional operation (P operation) in forward operation (cooling)

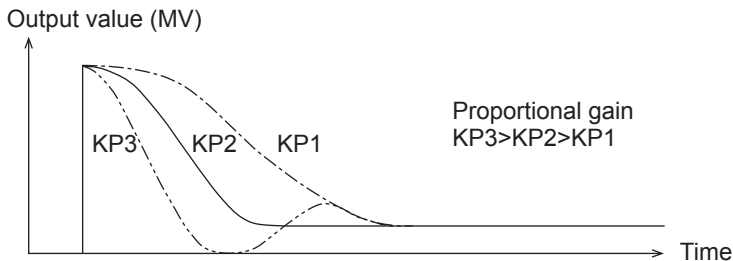
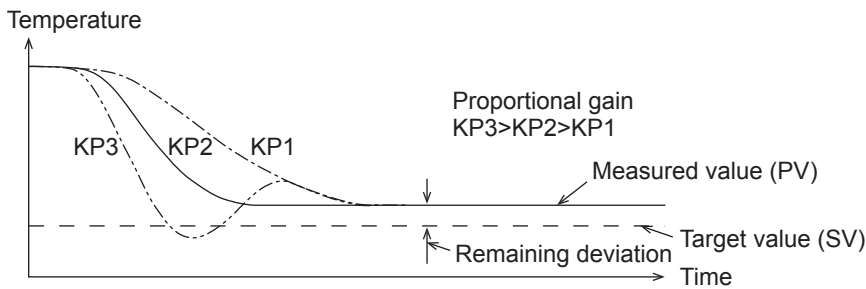

Integral time (s3)+4

During the integral operation, the time after deviation is generated until the integral operation output becomes the proportional operation output. This is called integral time and is expressed as "TI".

As TI becomes smaller, the integral operation becomes stronger.

Setting range: 0 to 32767 (× 100 ms). "0" is handled as "∞" (no integration).

Ex.

PI operation in backward operation (heating)

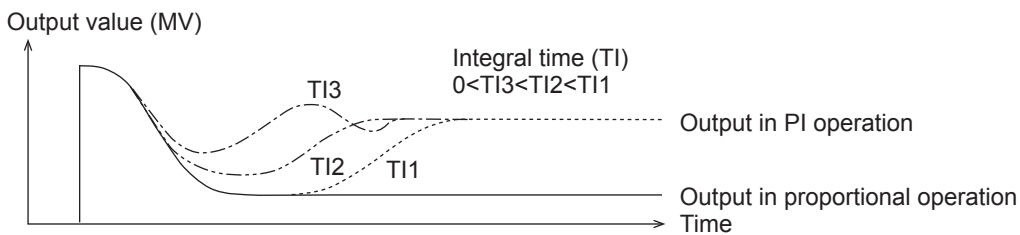
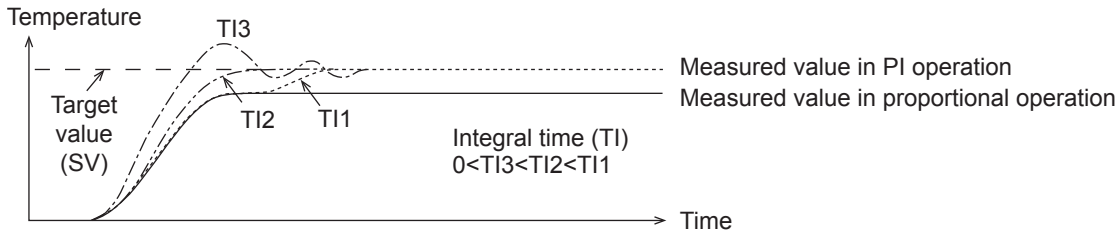

Ex.

PI operation in forward operation (cooling)

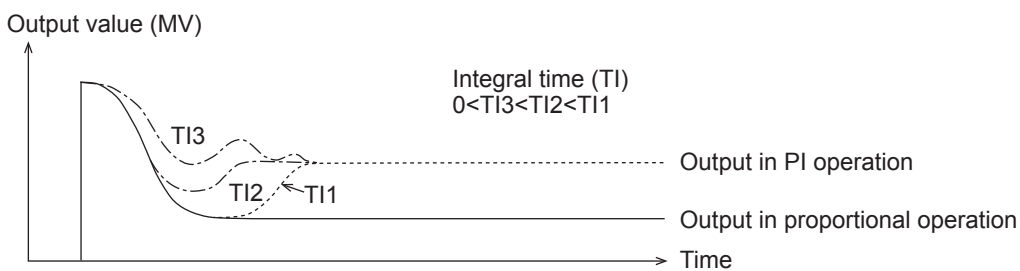
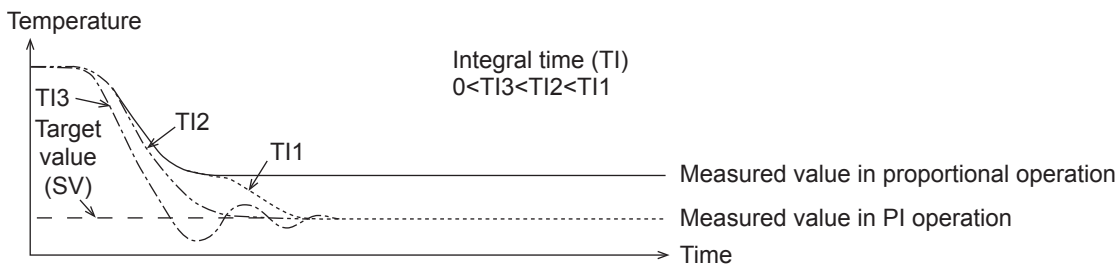

The integral operation changes the output so that the continuously generated deviation is eliminated. As a result, the remaining deviation generated in the proportional operation can be eliminated.

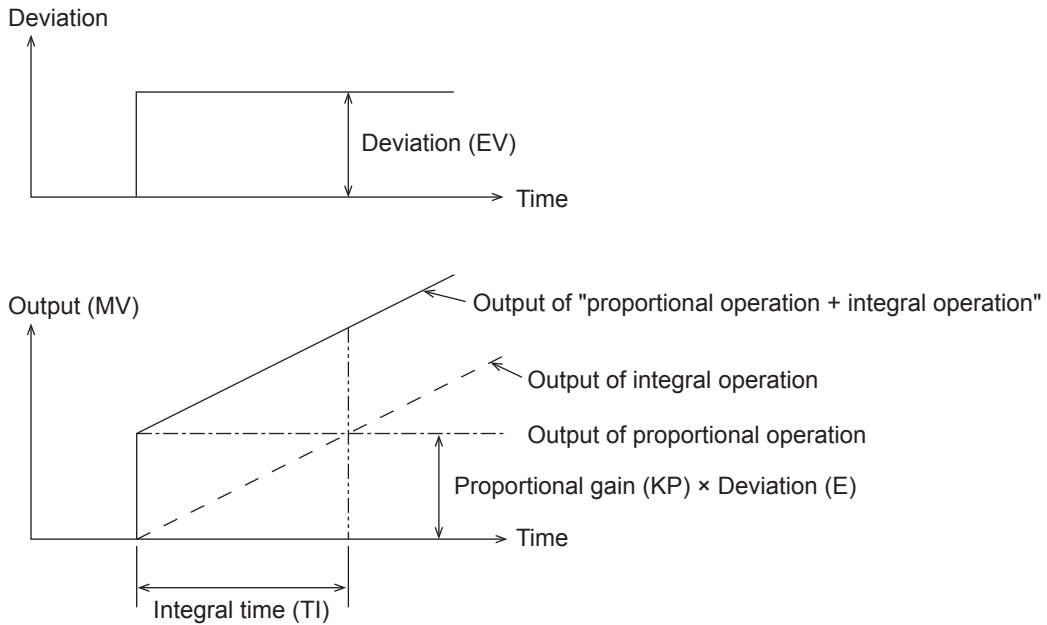

Differential gain (s3)+5

The filter is applied to the output at the differential operation. Setting range: 0 to 100 (%)

Only the differential operation is affected by the differential gain (KD).

- When the differential gain (KD) is small, the output is immediately given with regard to changes in the measured value (PV) caused by disturbance, etc.
- When the differential gain (KD) is large, the output is given after a long time with respect to changes in the measured value (PV) caused by disturbance, etc.

Set the differential gain (KD) to "0", and then adjust the operation using the input filter (α).

If the output response is too close to the disturbance, increase the differential gain (KD).

Differential time (s3)+6

Use the differential time (TD) to respond sensitively to fluctuations in the measured value (PV) caused by disturbance, etc. and to minimize the fluctuations. Setting range: 0 to 32767 (× 10 ms)

- When the differential time (TD) is large, it prevent large fluctuation in the control target caused by disturbance, etc.
- It is not always necessary to use the differential time (TD) (when disturbance is small, for example).

Deviation

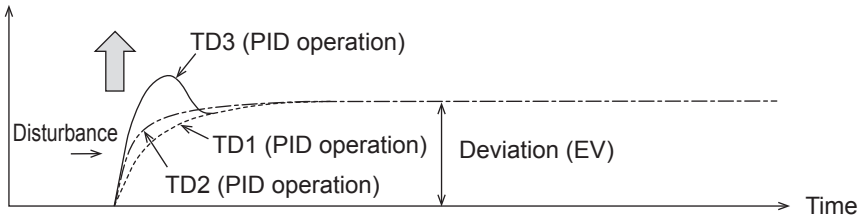

Output value (MV)

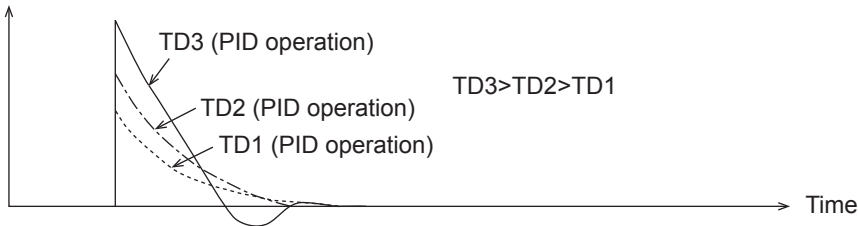

Ex.

PID operation in backward operation (heating)

Temperature

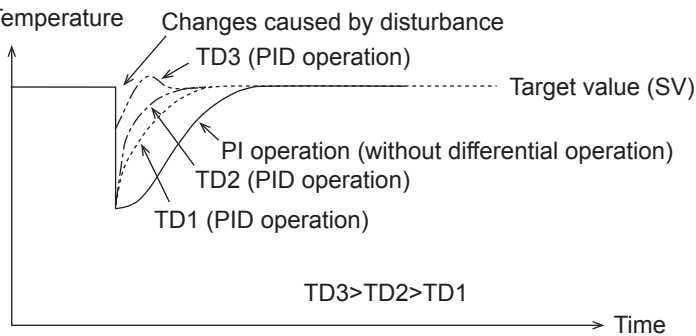

Output value (MV)

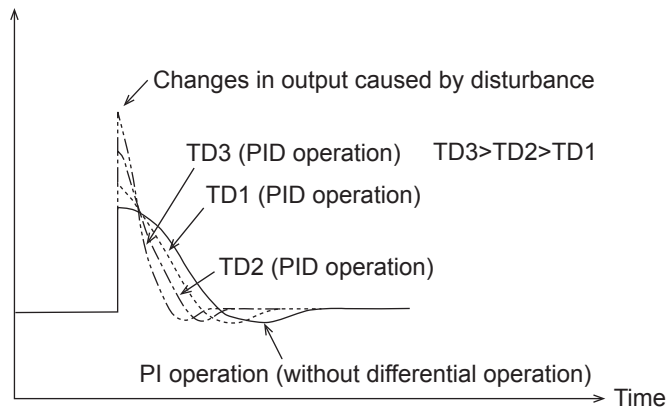

Ex.

PID operation in forward operation (cooling)

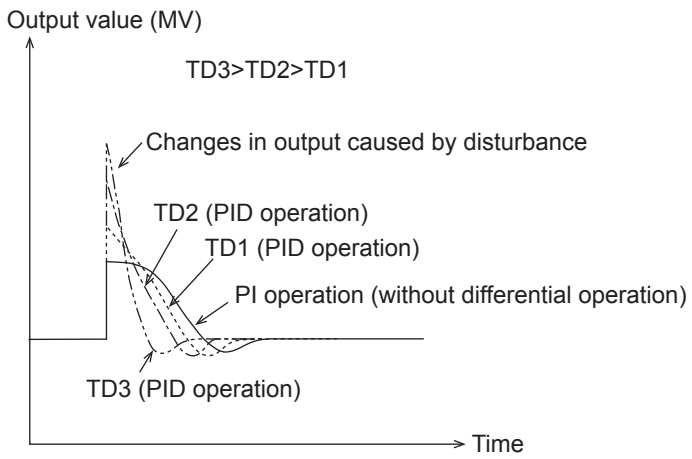
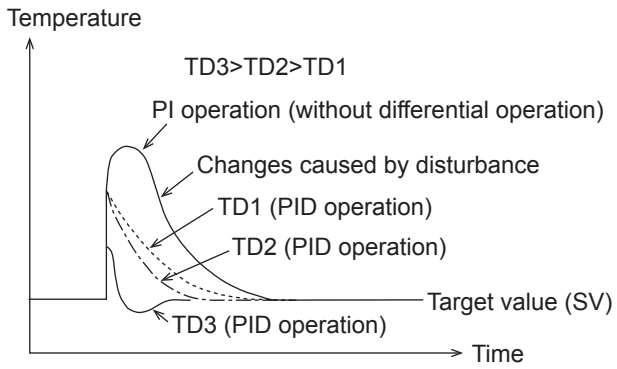

Alarm output (s3)+24

If the input variation and the output variation specified with (s3) +20 to (s3) +23 are exceeded, each bit of (s3) +24 turns ON as a warning output.

Item		Description	Remarks
Alarm output	(s3)+24: b0	OFF: Input variation (incremental) is not exceeded. ON: Input variation (incremental) is exceeded.	It is valid when operation setting (ACT) (b1 of (s3)+1) is "1".
	(s3)+24: b1	OFF: Input variation (incremental) is not exceeded. ON: Input variation (incremental) is exceeded.	
Alarm output	(s3)+24: b2	OFF: Output variation (incremental) is not exceeded. ON: Output variation (incremental) is exceeded.	It is valid when operation setting (ACT) (b2 of (s3)+1) is "1".
	(s3)+24: b3	OFF: Output variation (incremental) is not exceeded. ON: Output variation (incremental) is exceeded.	

In the case of input variation

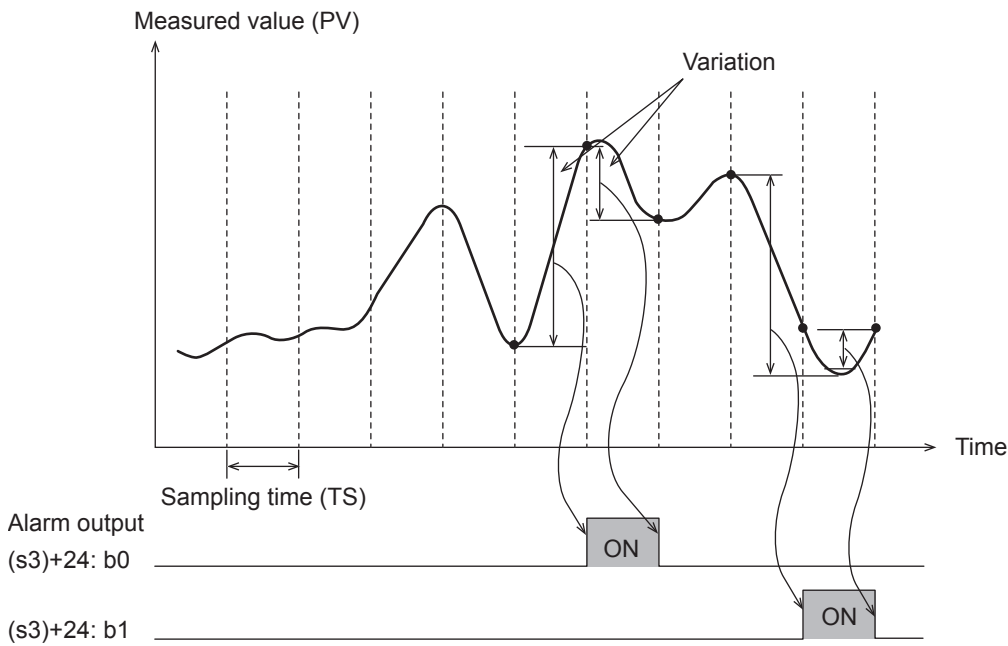

In the case of output variation

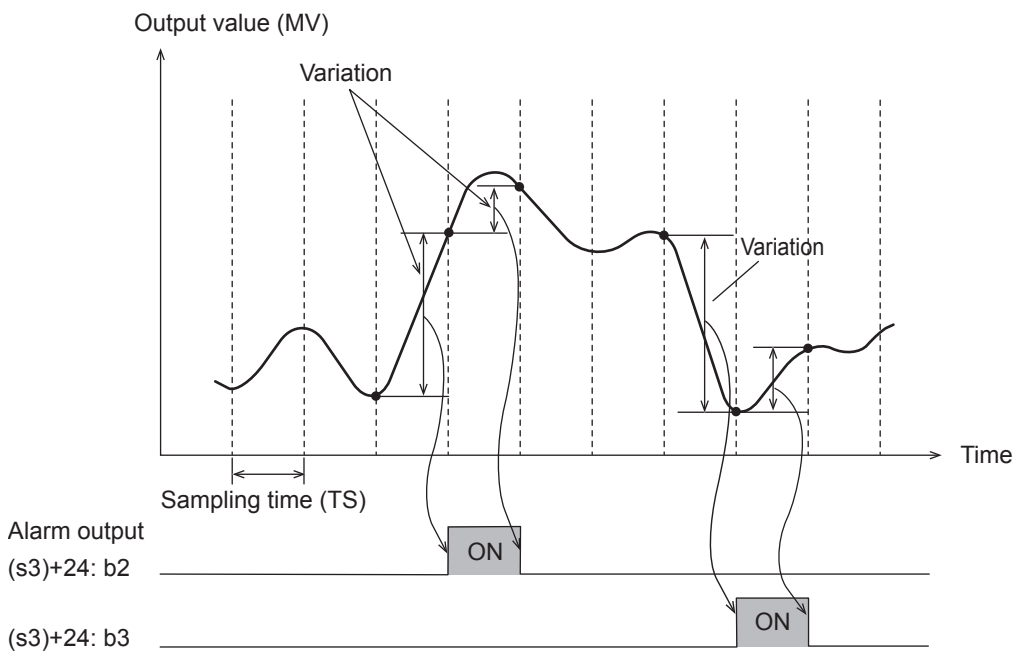

10.7 Auto-Tuning

This chapter describes the auto-tuning function of PID instruction.

The auto-tuning function will automatically set the important constants, such as the proportional gain and the integral time, to ensure optimum PID control. There are two auto-tuning methods: limit cycle method and step response method.

Limit Cycle Method

For acquiring satisfactory control results in PID control, it is necessary to obtain the optimal value of each constant (parameter) suitable to the control target. This paragraph explains the limit cycle method to obtain the amplitude (a) and vibration cycle (τ , τ_{on}) of the input value, and then calculate the proportional gain (KP), integral time (TI) and differential time (TD) based on the expressions shown in the table below.

What is the limit cycle method changes in the input value in two-position control (in which the output Upper Limit Value (ULV) and output Lower Limit Value (LLV) are switched according to the deviation) are measured, and then three constants in the PID control are obtained.

How to obtain three constants in PID control (Reference)

■ Operation characteristics and three constants

Control type	Proportional gain (KP) [%]	Integral time (TI) [$\times 100$ ms]	Differential time (TD) [$\times 10$ ms]
Only proportional control (P operation)	$\frac{1}{a}(ULV-LLV)\times 100$	—	—
PI control (PI operation)	$\frac{0.9}{a}(ULV-LLV)\times 100$	$33\times\tau_{on}\left(1-\frac{\tau_{on}}{\tau}\right)$	—
PID control (PID operation)	$\frac{1.2}{a}(ULV-LLV)\times 100$	$20\times\tau_{on}\left(1-\frac{\tau_{on}}{\tau}\right)$	$50\times\tau_{on}\left(1-\frac{\tau_{on}}{\tau}\right)$

■ Operation characteristics (in an example of backward operation)

During the " τW " period after the tuning cycle is finished, the output value is held at the output Lower Limit Value (LLV), and then normal PID control is started. The value " τW " can be obtained by the expression " $\tau W = (50 + KW)/100 \times (\tau - \tau_{on})$ ", and the wait setting parameter " KW " can be set in the parameter (s3)+28. (Setting range: $Kw = -50$ to $+32717$ [%]) (When the abnormal range is specified, " τW " is handled as "0")

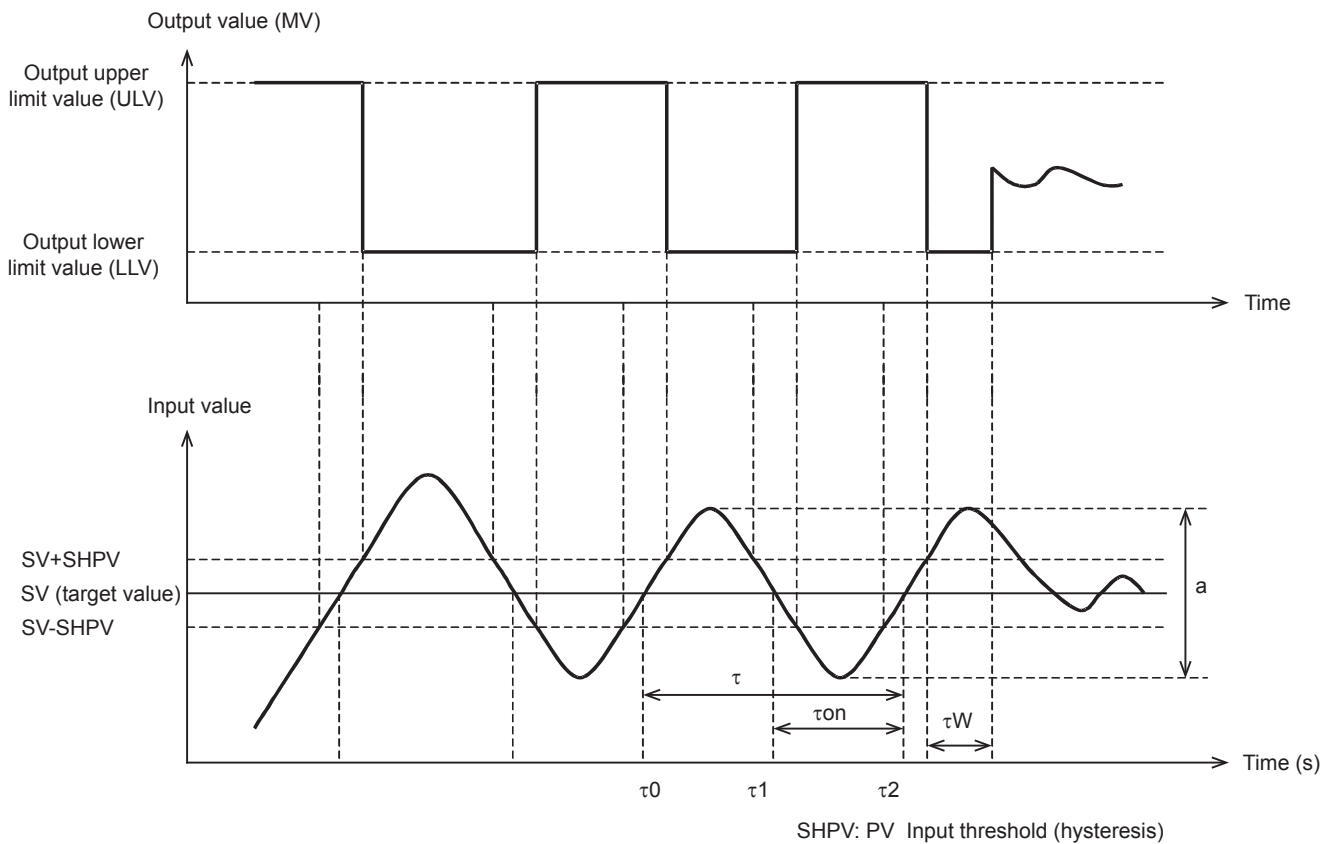

Parameters set in limit cycle method

The parameters specified in the limit cycle method are shown below.

Parameter	Setting position
Proportional gain (KP)	(s3)+3
Integral time (TI)	(s3)+4
Differential time (TD)	(s3)+6

Auto-tuning procedure

- 1.** Set forward or backward operation
Set the operation direction flag (b0) in the operation setting parameter (ACT) (s3)+1.
- 2.** Select the auto-tuning method (limit cycle method)
Set the auto-tuning method to ON (b6) in the operation setting parameter (ACT) (s3)+1. (When bit 6 is set to OFF, the step response method is selected.)
- 3.** Set the auto-tuning execution flag to ON
Set the auto-tuning execution flag to ON (b4) in the operation setting parameter (ACT) (s3)+1.
- 4.** Set the input filter
Set the input filter in the operation setting parameter (ACT) (s3)+2.
- 5.** Set the sampling time
Set the sampling time (s3).
- 6.** Set the Upper Limit Value (ULV)
Set the Upper Limit Value (ULV) of the output value (MV) in the operation setting parameter (ACT) (s3)+26.
- 7.** Set the Lower Limit Value (LLV)
Set the Lower Limit Value (LLV) of the output value (MV) in the operation setting parameter (ACT) (s3)+27.
- 8.** Set the threshold (hysteresis) (SHPV)
Set the threshold (hysteresis) width (SHPV) in the operation setting parameter (ACT) (s3)+25.
- 9.** Set the target value (SV)
Set the target value (SV) in PID instruction.
- 10.** Set the PID instruction command input ON to start auto-tuning
Auto-tuning is executed according to the measured value (PV).
When auto-tuning is completed, the auto-tuning flag (b4 and b6) turns OFF in the operation setting parameter (ACT) (s3)+1.

Step Response Method

For acquiring satisfactory control results during PID control, it is necessary to obtain the optimal value of each constant (parameter) suitable for the control target. This paragraph explains the step response method to obtain three constants in the PID control (proportional gain (KP), integral time (TI) and differential time (TD)).

In this method, by giving stepped output from 0 to 100 % to the control system, three constants in the PID control are obtained from the operation characteristics (maximum ramp (R) and dead time (L)) and the input value variation. The stepped output may be obtained from 0 to 75% or from 0 to 50 %.

How to obtain three constants in PID control (Reference)

■ Operation characteristics and three constants

Control type	Proportional gain (KP) [%]	Integral time (TI) [$\times 100$ ms]	Differential time (TD) [$\times 10$ ms]
Only proportional control (P operation)	$\frac{1}{RL} \times \text{Output value (MV)} \times 100$	—	—
PI control (PI operation)	$\frac{0.9}{RL} \times \text{Output value (MV)} \times 100$	33L	—
PID control (PID operation)	$\frac{1.2}{RL} \times \text{Output value (MV)} \times 100$	20L	50L

■ Operation characteristics

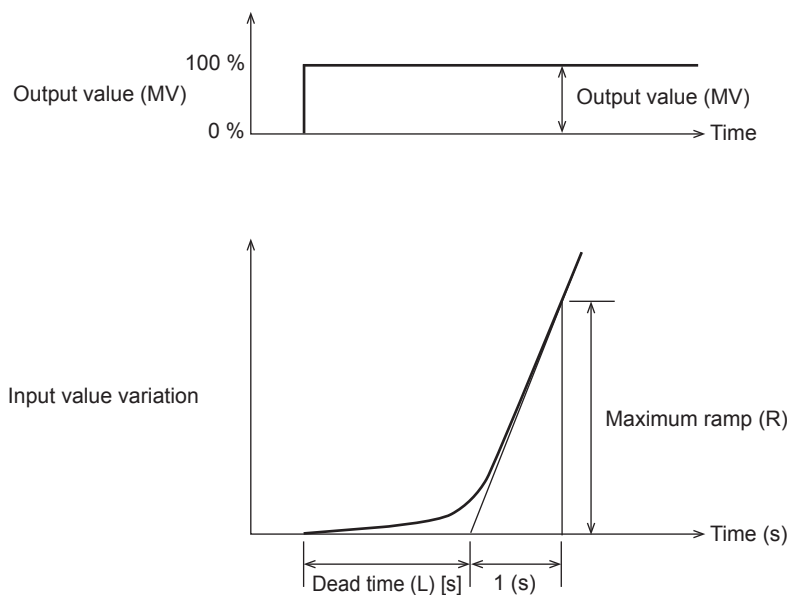

Parameters set in step response method

The parameters specified in the step response method are shown below.

Parameter	Setting position
Operation setting (ACT)	(s3)+1: b0 (operation direction)
Proportional gain (KP)	(s3)+3
Integral time (TI)	(s3)+4
Differential time (TD)	(s3)+6

Auto-tuning procedure

1. Transferring the output value for auto-tuning to the output value (d)

Set the output value for auto-tuning to the maximum available output value multiplied by 0.5 to 1 for the output equipment.

2. Setting the parameter (s3), target value (SV), etc. that cannot be set in autotuning according to the system

3. Set the auto-tuning execution flag to ON

Set the auto-tuning execution flag to ON (b4) in the operation setting parameter (ACT) (s3)+1.

4. Set the PID instruction command input ON to start auto-tuning

Auto-tuning is executed according to the measured value (PV).

When auto-tuning is completed, the auto-tuning flag (b4) turns OFF in the operation setting parameter (ACT) (s3)+1.

Point

Start auto-tuning while the system is stable.

If the system is unstable when auto-tuning is started, auto-tuning may not be executed normally.

Cautions on auto-tuning setting

Note that auto-tuning may not be executed normally if the cautions described below are not followed

- Difference between the target value (SV) and the measured value (PV)

If the difference between the target value (SV) and the measured value (PV) is less than 75 when autotuning is started, auto-tuning is not executed normally. Accordingly, if the difference is less than 75, set the target value for auto-tuning. Set the target value again when auto-tuning is completed.

- Sampling time (TS)

Make sure the sampling time is set for auto-tuning to 1 second (1000 ms) or more. It is recommended that the sampling time is set to that it is considerably longer than the output change cycle.

Cautions on auto-tuning execution

■ Program countermeasures when the input value (PV) does not change

When the input value (PV) does not change normally due to factors such as wire breakage in an analog input line, auto-tuning is not finished. Detect and avoid such occurrences by introducing a sequence to monitor the input value or the elapsed time from the start of auto-tuning.

10.8 Examples of Program

System configuration example

An example of the system configuration when the PID control function is used is shown below.

System configuration

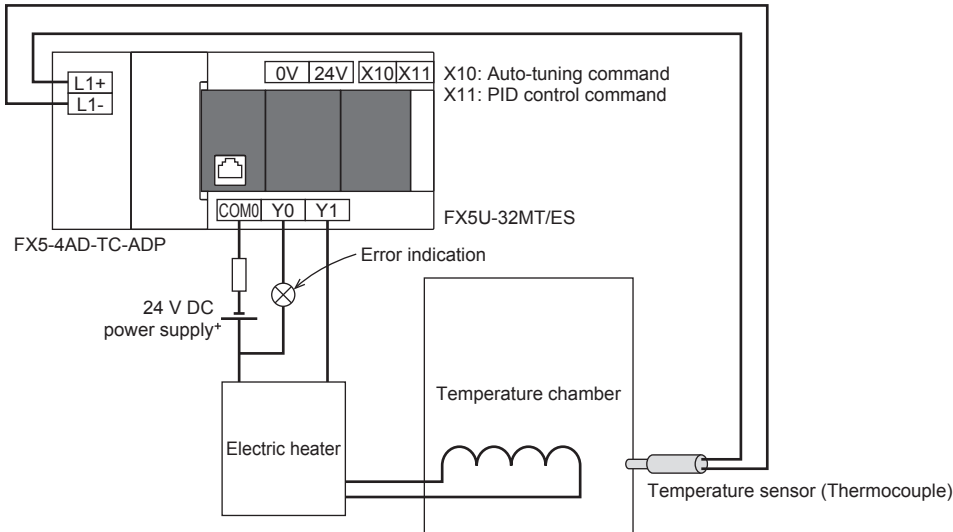

Operation of the electric heater

The operation of the electric heater (Y1) is as follows.

■ During PID control

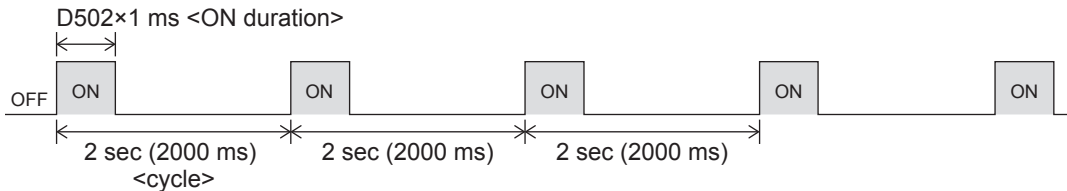

■ During auto-tuning (In case of 90% of maximum output)

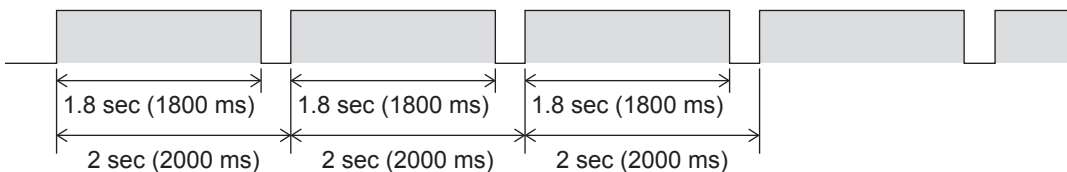

Program examples

Program example	Description	Reference
Program example 1	This is an example of the sample program for PID control.	Page 99
Program example 2	This is an example of the sample program for auto tuning (limit cycle method).	Page 101
Program example 3	This is an example of the sample program for auto tuning (step response method).	Page 103
Program example 4	This is an example of the sample program for auto tuning (limit cycle method) + PID control.	Page 105
Program example 5	This is an example of the sample program for auto tuning (step response method) + PID control.	Page 107

Program example 1

This is an example of the sample program for PID control.

Use device

The content of the devices used for the program is as follows.

Item		Device	Setting value		
			During auto-tuning	During PID control	
Target value (SV) ^{*1}		(s1)	D500	Not used	500 (50.0°C)
Measured value (PV) ^{*1}		(s2)	SD6300 ^{*2}	Not used	According to input value
Parameter	Sampling time (TS) ^{*1}	(s3)	D510	Not used	500 (500 ms)
	Operation setting (ACT)	Operation direction ^{*1}	(s3)+1 b0	D511.0	Not used
Input variation alarm		(s3)+1 b1	D511.1	Not used	0 (Alarm is not provided)
Output variation alarm		(s3)+1 b2	D511.2	Not used	0 (Alarm is not provided)
Auto-tuning		(s3)+1 b4	D511.4	Not used	0 (AT is not provided)
Upper and lower limits of output value		(s3)+1 b5	D511.5	Not used	1 (Setting is provided)
Select auto-tuning mode		(s3)+1 b6	D511.6	Not used	Not used
Overshoot suppression setting		(s3)+1 b7	D511.7	Not used	1 (Used)
Hunting suppression setting		(s3)+1 b8	D511.8	Not used	Not used
Input filter constant (α)		(s3)+2	D512	Not used	0 (Input filter is not provided)
Proportional gain (KP) ^{*1}		(s3)+3	D513	Not used	3000 (3000 %)
Integral time (TI) ^{*1}		(s3)+4	D514	Not used	2000 (2000×100 ms)
Differential gain (KD)		(s3)+5	D515	Not used	0 (Differential gain is not provided)
Differential time (TD) ^{*1}		(s3)+6	D516	Not used	5000 (5000×10 ms)
Input variation (incremental) alarm set value		(s3)+20	D530	Not used	Not used
Input variation (decremental) alarm set value		(s3)+21	D531	Not used	Not used
Output variation (incremental) alarm set value Output upper limit set value		(s3)+22	D532	Not used	2000 (2 second)
Output variation (decremental) alarm set value Output lower limit set value		(s3)+23	D533	Not used	0 (0 second)
Alarm output	Input variation (incremental) is exceeded	(s3)+24 b0	D534.0	Not used	Not used
	Input variation (decremental) is exceeded	(s3)+24 b1	D534.1	Not used	Not used
	Output variation (incremental) is exceeded	(s3)+24 b2	D534.2	Not used	Not used
	Output variation (decremental) is exceeded	(s3)+24 b3	D534.3	Not used	Not used
PV value threshold (hysteresis) width (SHPV)		(s3)+25	D535	—	—
Output value upper limit (ULV)		(s3)+26	D536	—	—
Output value lower limit (LLV)		(s3)+27	D537	—	—
Wait setting from end of tuning cycle to start of PID control (KW)		(s3)+28	D538	—	—
Output value (MV) ^{*1}		(d)	D502	Not used	According to operation

—: This is an item not occupied.

*1 The setting is always necessary.

*2 When CH1 is used.

Program

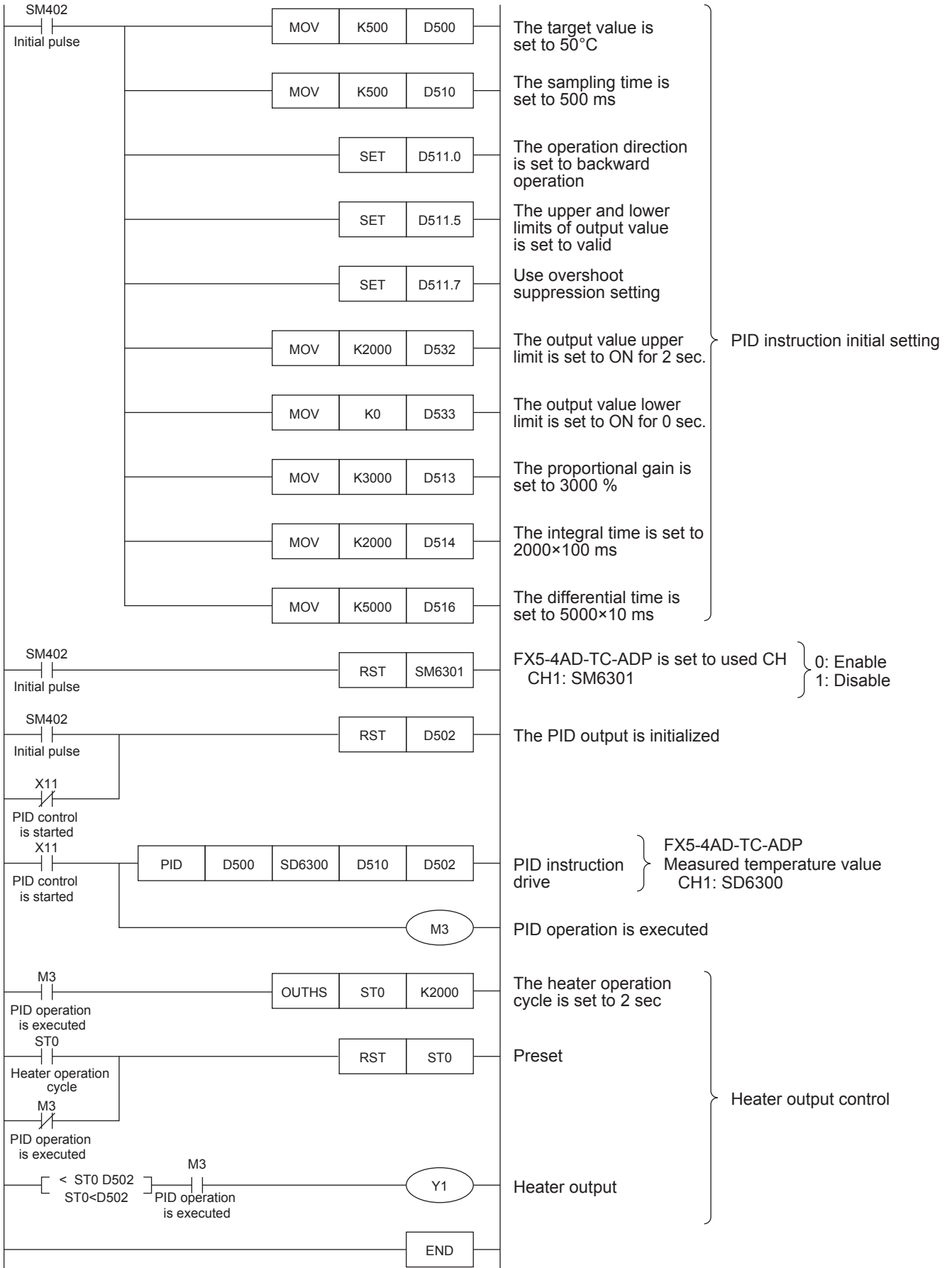

Program example 2

This is an example of the sample program for auto tuning (limit cycle method).

Use device

The content of the devices used for the program is as follows.

Item		Device	Setting value		
			During auto-tuning	During PID control	
Target value (SV) ^{*1}		(s1)	D500	500 (50.0°C)	Not used
Measured value (PV) ^{*1}		(s2)	SD6300 ^{*2}	According to input value	Not used
Parameter	Sampling time (TS) ^{*1}	(s3)	D510	500 (500 ms)	Not used
	Operation setting (ACT)	Operation direction ^{*1}	(s3)+1 b0	D511.0	1 (Backward operation)
Input variation alarm		(s3)+1 b1	D511.1	0 (Alarm is not provided)	Not used
Output variation alarm		(s3)+1 b2	D511.2	0 (Alarm is not provided)	Not used
Auto-tuning		(s3)+1 b4	D511.4	1 (AT is provided)	Not used
Upper and lower limits of output value		(s3)+1 b5	D511.5	0 (Setting is not provided)	Not used
Select auto-tuning mode		(s3)+1 b6	D511.6	1 (Limit cycle method)	Not used
Overshoot suppression setting		(s3)+1 b7	D511.7	Not used	Not used
Hunting suppression setting		(s3)+1 b8	D511.8	Not used	Not used
Input filter constant (α)		(s3)+2	D512	0 (Input filter is not provided)	Not used
Proportional gain (KP) ^{*1}		(s3)+3	D513	According to auto-tuning result	Not used
Integral time (TI) ^{*1}		(s3)+4	D514	According to auto-tuning result	Not used
Differential gain (KD)		(s3)+5	D515	0 (Differential gain is not provided)	Not used
Differential time (TD) ^{*1}		(s3)+6	D516	According to auto-tuning result	Not used
Input variation (incremental) alarm set value		(s3)+20	D530	Not used	Not used
Input variation (decremental) alarm set value		(s3)+21	D531	Not used	Not used
Output variation (incremental) alarm set value		(s3)+22	D532	Not used	Not used
Output upper limit set value					
Output variation (decremental) alarm set value		(s3)+23	D533	Not used	Not used
Output lower limit set value					
Alarm output	Input variation (incremental) is exceeded	(s3)+24 b0	D534.0	Not used	Not used
	Input variation (decremental) is exceeded	(s3)+24 b1	D534.1	Not used	Not used
	Output variation (incremental) is exceeded	(s3)+24 b2	D534.2	Not used	Not used
	Output variation (decremental) is exceeded	(s3)+24 b3	D534.3	Not used	Not used
PV value threshold (hysteresis) width (SHPV)		(s3)+25	D535	500 (5.0°C)	Not used
Output value upper limit (ULV)		(s3)+26	D536	2000 (2 second)	Not used
Output value lower limit (LLV)		(s3)+27	D537	0 (0 second)	Not used
Wait setting from end of tuning cycle to start of PID control (KW)		(s3)+28	D538	-50 (Wait is not provided)	Not used
Output value (MV) ^{*1}		(d)	D502	According to operation	Not used

—: This is an item not occupied.

*1 The setting is always necessary.

*2 When CH1 is used.

Program

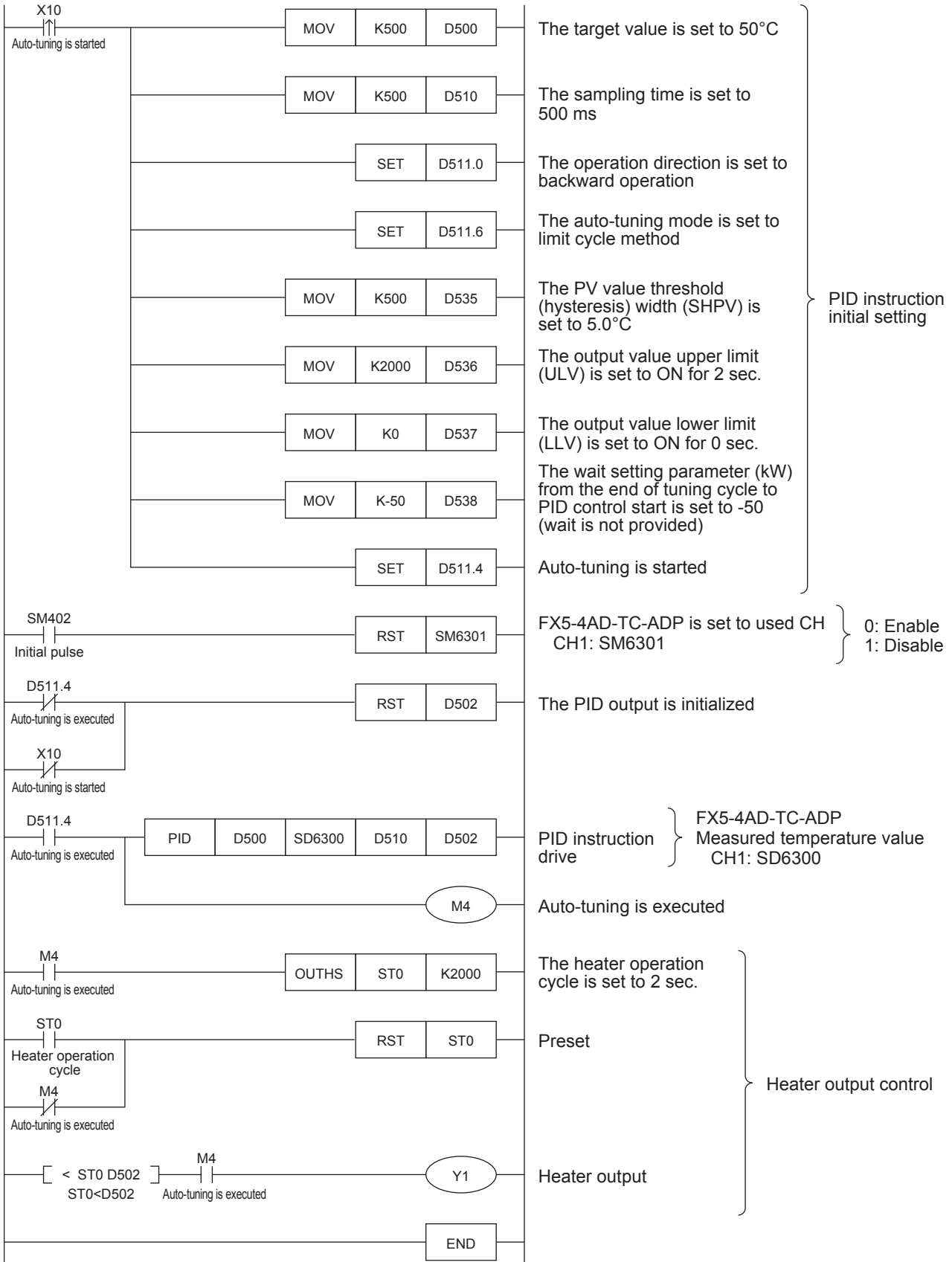

Program example 3

This is an example of the sample program for auto tuning (step response method).

Use device

The content of the devices used for the program is as follows.

Item		Device	Setting value			
			During auto-tuning	During PID control		
Target value (SV) ^{*1}		(s1)	D500	500 (50.0°C)	Not used	
Measured value (PV) ^{*1}		(s2)	SD6300 ^{*2}	According to input value	Not used	
Parameter	Sampling time (TS) ^{*1}	(s3)	D510	1000 (1000ms)	Not used	
	Operation setting (ACT)	Operation direction ^{*1}	(s3)+1 b0	D511.0	According to auto-tuning result	Not used
		Input variation alarm	(s3)+1 b1	D511.1	0 (Alarm is not provided)	Not used
		Output variation alarm	(s3)+1 b2	D511.2	0 (Alarm is not provided)	Not used
		Auto-tuning	(s3)+1 b4	D511.4	1 (AT is provided)	Not used
		Upper and lower limits of output value	(s3)+1 b5	D511.5	0 (Setting is not provided)	Not used
		Select auto-tuning mode	(s3)+1 b6	D511.6	0 (Step response method)	Not used
		Overshoot suppression setting	(s3)+1 b7	D511.7	Not used	Not used
		Hunting suppression setting	(s3)+1 b8	D511.8	1 (Timeout time is valid)	Not used
	Input filter constant (α)	(s3)+2	D512	0 (Input filter is not provided)	Not used	
	Proportional gain (KP) ^{*1}	(s3)+3	D513	According to auto-tuning result	Not used	
	Integral time (TI) ^{*1}	(s3)+4	D514	According to auto-tuning result	Not used	
	Differential gain (KD)	(s3)+5	D515	0 (Differential gain is not provided)	Not used	
	Differential time (TD) ^{*1}	(s3)+6	D516	According to auto-tuning result	Not used	
	Input variation (incremental) alarm set value	(s3)+20	D530	Not used	Not used	
	Input variation (decremental) alarm set value	(s3)+21	D531	Not used	Not used	
	Output variation (incremental) alarm set value Output upper limit set value	(s3)+22	D532	Not used	Not used	
	Output variation (decremental) alarm set value Output lower limit set value	(s3)+23	D533	Not used	Not used	
	Alarm output	Input variation (incremental) is exceeded	(s3)+24 b0	D534.0	Not used	Not used
		Input variation (decremental) is exceeded	(s3)+24 b1	D534.1	Not used	Not used
		Output variation (incremental) is exceeded	(s3)+24 b2	D534.2	Not used	Not used
		Output variation (decremental) is exceeded	(s3)+24 b3	D534.3	Not used	Not used
	Timeout time setting value after maximum ramp (R) detection	(s3)+25	D535	10 (10 second)	Not used	
	Used by system	(s3)+26	D536	Not used	Not used	
	Used by system	(s3)+27	D537	Not used	Not used	
	Wait setting from end of tuning cycle to start of PID control (KW)	(s3)+28	D538	—	—	
	Output value (MV) ^{*1}		(d)	D502	1800 (1.8 second)	Not used

—: This is an item not occupied.

*1 The setting is always necessary.

*2 When CH1 is used.

Program

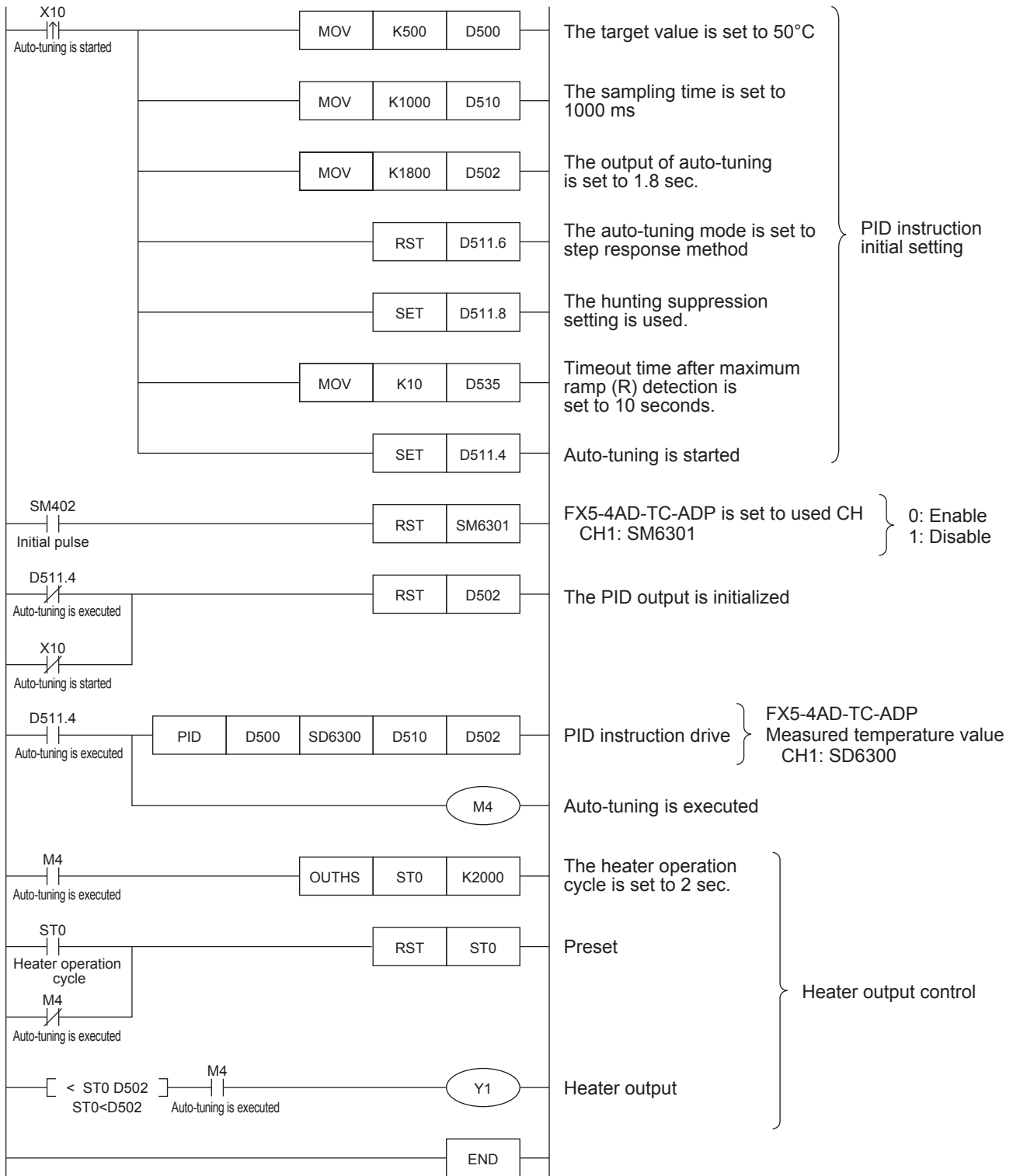

Program example 4

This is an example of the sample program for auto tuning (limit cycle method) + PID control.

Use device

The content of the devices used for the program is as follows.

Item		Device	Setting value		
			During auto-tuning	During PID control	
Target value (SV) ^{*1}		(s1)	D500	500 (50.0°C)	500 (50.0°C)
Measured value (PV) ^{*1}		(s2)	SD6300 ^{*2}	According to input value	According to input value
Parameter	Sampling time (TS) ^{*1}	(s3)	D510	500 (500 ms)	500 (500 ms)
	Operation setting (ACT)	Operation direction ^{*1}	(s3)+1 b0	D511.0	1 (Backward operation)
Input variation alarm		(s3)+1 b1	D511.1	0 (Alarm is not provided)	0 (Alarm is not provided)
Output variation alarm		(s3)+1 b2	D511.2	0 (Alarm is not provided)	0 (Alarm is not provided)
Auto-tuning		(s3)+1 b4	D511.4	1 (AT is provided)	1 (AT is provided)
Upper and lower limits of output value		(s3)+1 b5	D511.5	1 (Setting is provided)	1 (Setting is provided)
Select auto-tuning mode		(s3)+1 b6	D511.6	1 (Limit cycle method)	Not used
Overshoot suppression setting		(s3)+1 b7	D511.7	Not used	1 (Used)
Hunting suppression setting		(s3)+1 b8	D511.8	Not used	Not used
Input filter constant (α)		(s3)+2	D512	0 (Input filter is not provided)	0 (Input filter is not provided)
Proportional gain (KP) ^{*1}		(s3)+3	D513	According to auto-tuning result	According to auto-tuning result
Integral time (TI) ^{*1}		(s3)+4	D514	According to auto-tuning result	According to auto-tuning result
Differential gain (KD)		(s3)+5	D515	0 (Differential gain is not provided)	0 (Differential gain is not provided)
Differential time (TD) ^{*1}		(s3)+6	D516	According to auto-tuning result	According to auto-tuning result
Input variation (incremental) alarm set value		(s3)+20	D530	Not used	Not used
Input variation (decremental) alarm set value		(s3)+21	D531	Not used	Not used
Output variation (incremental) alarm set value Output upper limit set value		(s3)+22	D532	Not used	2000 (2 second)
Output variation (decremental) alarm set value Output lower limit set value		(s3)+23	D533	Not used	0 (0 second)
Alarm output	Input variation (incremental) is exceeded	(s3)+24 b0	D534.0	Not used	Not used
	Input variation (decremental) is exceeded	(s3)+24 b1	D534.1	Not used	Not used
	Output variation (incremental) is exceeded	(s3)+24 b2	D534.2	Not used	Not used
	Output variation (decremental) is exceeded	(s3)+24 b3	D534.3	Not used	Not used
PV value threshold (hysteresis) width (SHPV)		(s3)+25	D535	500 (5.0°C)	Not used
Output value upper limit (ULV)		(s3)+26	D536	2000 (2 second)	Not used
Output value lower limit (LLV)		(s3)+27	D537	0 (0 second)	Not used
Wait setting from end of tuning cycle to start of PID control (KW)		(s3)+28	D538	-50 (Wait is not provided)	Not used
Output value (MV) ^{*1}		(d)	D502	According to operation	According to operation

—: This is an item not occupied.

*1 The setting is always necessary.

*2 When CH1 is used.

Program

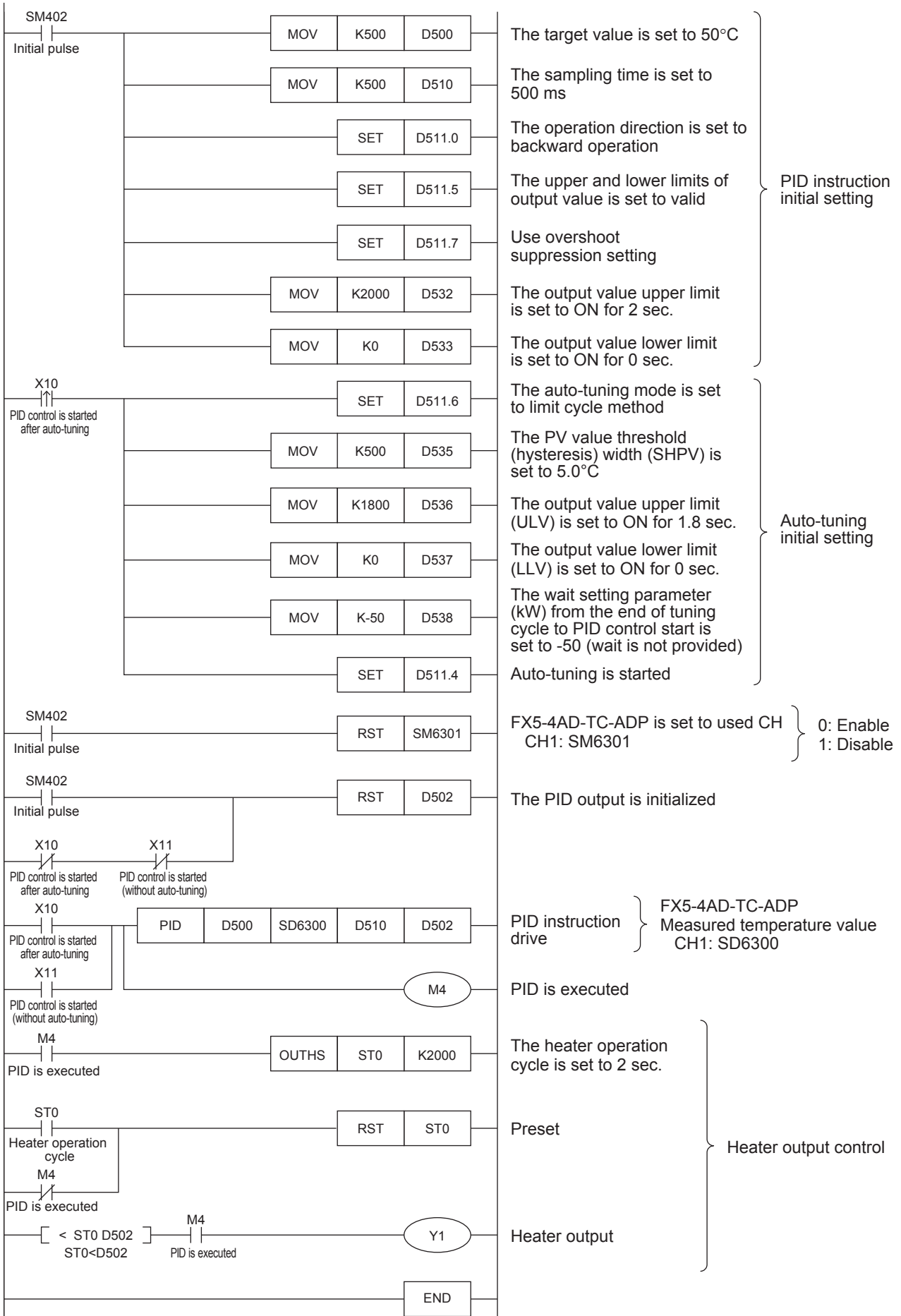

Program example 5

This is an example of the sample program for auto tuning (step response method) + PID control.

Use device

The content of the devices used for the program is as follows.

Item		Device	Setting value		
			During auto-tuning	During PID control	
Target value (SV) ^{*1}		(s1)	D500	500 (50.0°C)	500 (50.0°C)
Measured value (PV) ^{*1}		(s2)	SD6300 ^{*2}	According to input value	According to input value
Parameter	Sampling time (TS) ^{*1}	(s3)	D510	1000 (1000 ms)	500 (500 ms)
	Operation setting (ACT)	Operation direction ^{*1}	(s3)+1 b0	D511.0	According to auto-tuning result
Input variation alarm		(s3)+1 b1	D511.1	0 (Alarm is not provided)	0 (Alarm is not provided)
Output variation alarm		(s3)+1 b2	D511.2	0 (Alarm is not provided)	0 (Alarm is not provided)
Auto-tuning		(s3)+1 b4	D511.4	1 (AT is provided)	0 (AT is not provided)
Upper and lower limits of output value		(s3)+1 b5	D511.5	1 (Setting is provided)	Not used
Select auto-tuning mode		(s3)+1 b6	D511.6	0 (Step response method)	Not used
Overshoot suppression setting		(s3)+1 b7	D511.7	Not used	1 (Used)
Hunting suppression setting		(s3)+1 b8	D511.8	1 (Timeout time is valid)	Not used
Input filter constant (α)		(s3)+2	D512	0 (Input filter is not provided)	0 (Input filter is not provided)
Proportional gain (KP) ^{*1}		(s3)+3	D513	According to auto-tuning result	According to auto-tuning result
Integral time (TI) ^{*1}		(s3)+4	D514	According to auto-tuning result	According to auto-tuning result
Differential gain (KD)		(s3)+5	D515	0 (Differential gain is not provided)	0 (Differential gain is not provided)
Differential time (TD) ^{*1}		(s3)+6	D516	According to auto-tuning result	According to auto-tuning result
Input variation (incremental) alarm set value		(s3)+20	D530	Not used	Not used
Input variation (decremental) alarm set value		(s3)+21	D531	Not used	Not used
Output variation (incremental) alarm set value Output upper limit set value		(s3)+22	D532	Not used	2000 (2 second)
Output variation (decremental) alarm set value Output lower limit set value		(s3)+23	D533	Not used	0 (0 second)
Alarm output	Input variation (incremental) is exceeded	(s3)+24 b0	D534.0	Not used	Not used
	Input variation (decremental) is exceeded	(s3)+24 b1	D534.1	Not used	Not used
	Output variation (incremental) is exceeded	(s3)+24 b2	D534.2	Not used	Not used
	Output variation (decremental) is exceeded	(s3)+24 b3	D534.3	Not used	Not used
Timeout time setting value after maximum ramp (R) detection		(s3)+25	D535	10 (10 second)	Not used
Used by system		(s3)+26	D536	Not used	Not used
Used by system		(s3)+27	D537	Not used	Not used
Wait setting from end of tuning cycle to start of PID control (KW)		(s3)+28	D538	—	—
Output value (MV) ^{*1}		(d)	D502	1800 (1.8 second)	According to operation

—: This is an item not occupied.

*1 The setting is always necessary.

*2 When CH1 is used.

Program

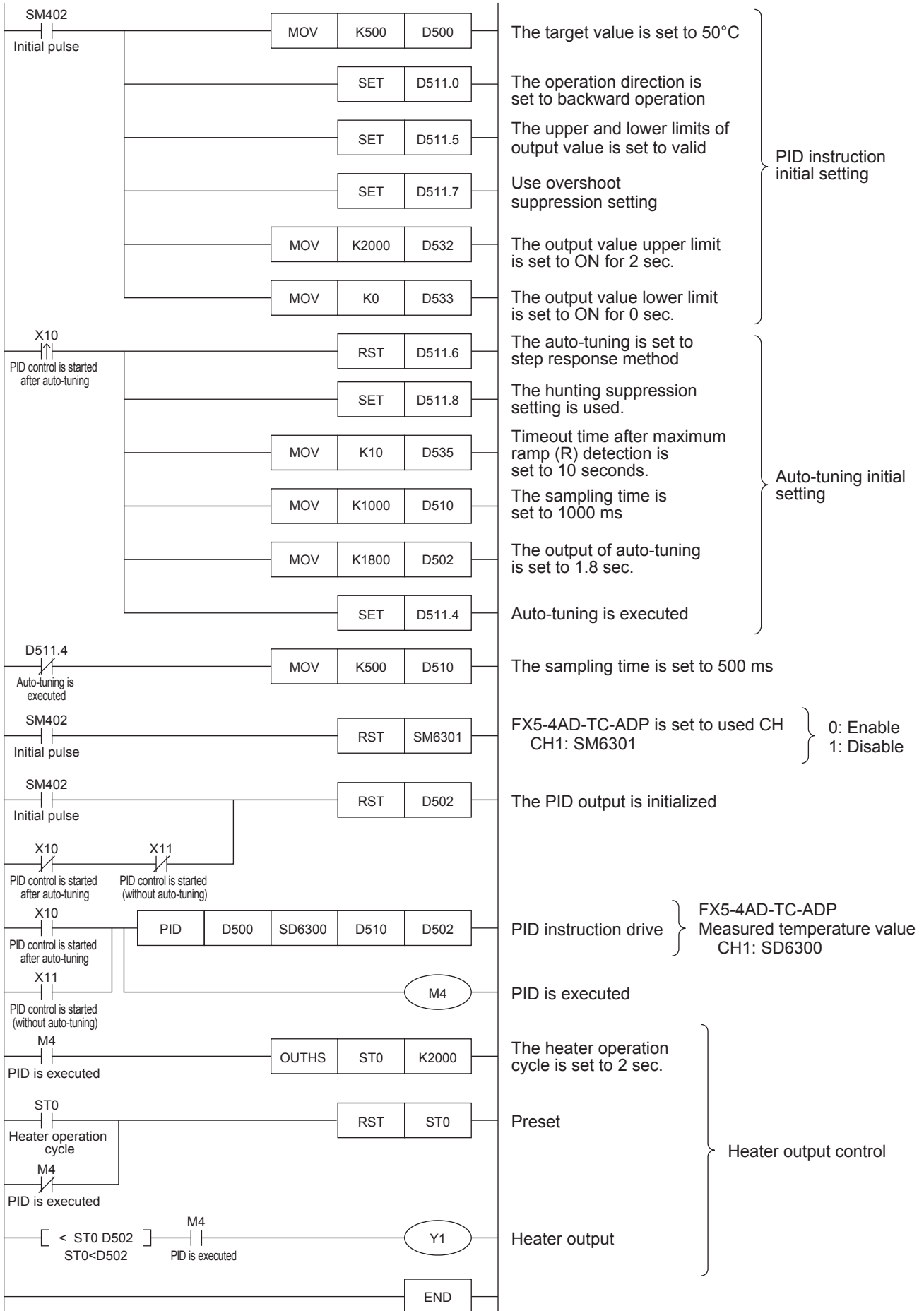

10.9 Example of parameter adjustment and the effect on PID control operation

This section describes parameters that can be adjusted to improve the PID control result and the effect of the parameters.

Improvement of control results

The following table shows the outline of the details to be improved and methods for improvement.

Details to be improved	Auto-Tuning	Contents
Overshoot suppression	Auto-tuning is executed	Use overshoot suppression setting.
	Auto-tuning is not executed	Use overshoot suppression setting.
		Increase the integral time and execute.
Hunting suppression	Auto-tuning is executed	Shorten the sampling time and execute.
		Use the hunting suppression setting.
		Set the sampling time to be the output period or more and execute.
	Auto-tuning is not executed	Increase the filter input value and execute.
		Decrease the proportional gain and execute.
Reduction of remaining deviation	—	Increase the differential time and execute.
		Shorten the sampling time and execute.
		Increase the filter input value and execute.

Overshoot suppression

When suppressing overshoot, the operation is as follows.

■When auto-tuning is executed

When the step response method and the PID control are executed continuously and the following results are obtained, use the overshoot suppression setting (turn ON b7 of (s3)+1). The overshoot amount may be suppressed.

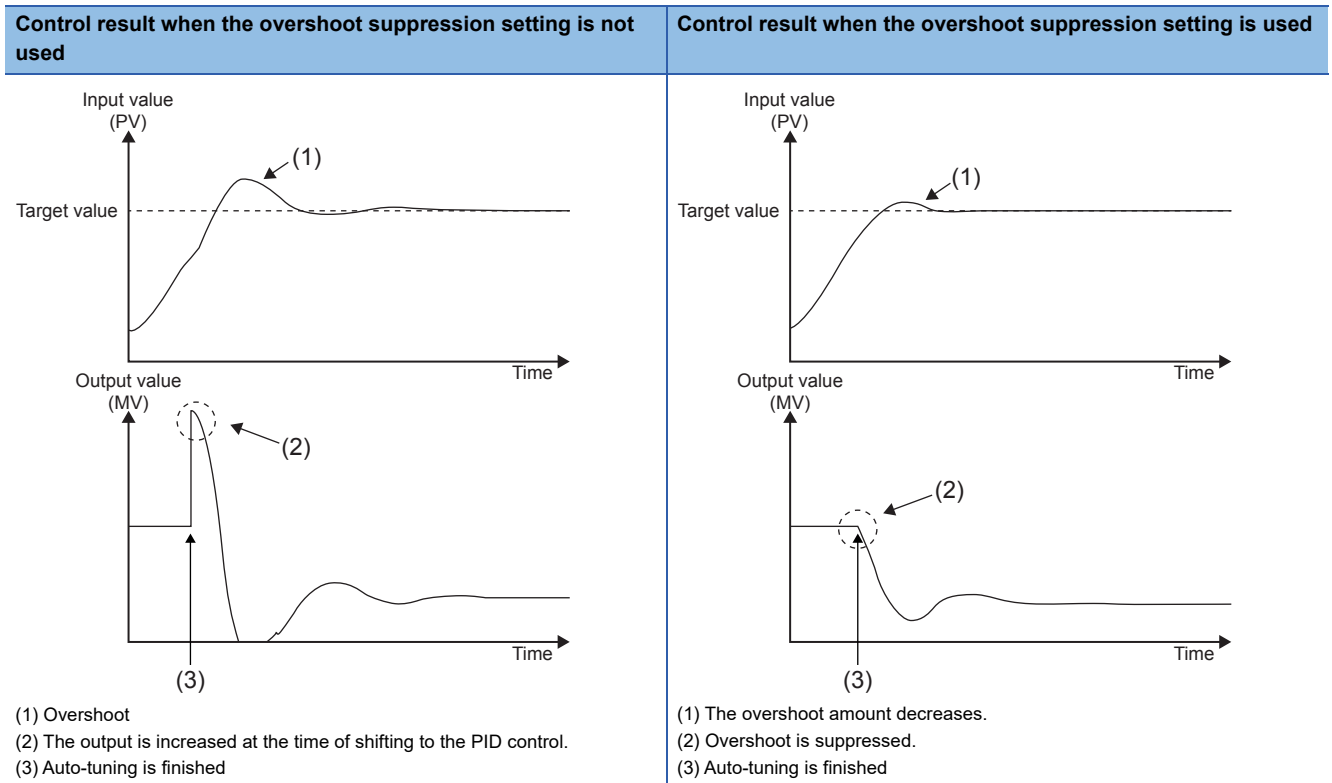

■ When auto-tuning is not executed

When the PID control is executed and a large initial output causes overshoot, use the overshoot suppression setting (b7 of (s3)+1 turns ON). The overshoot amount may be suppressed.

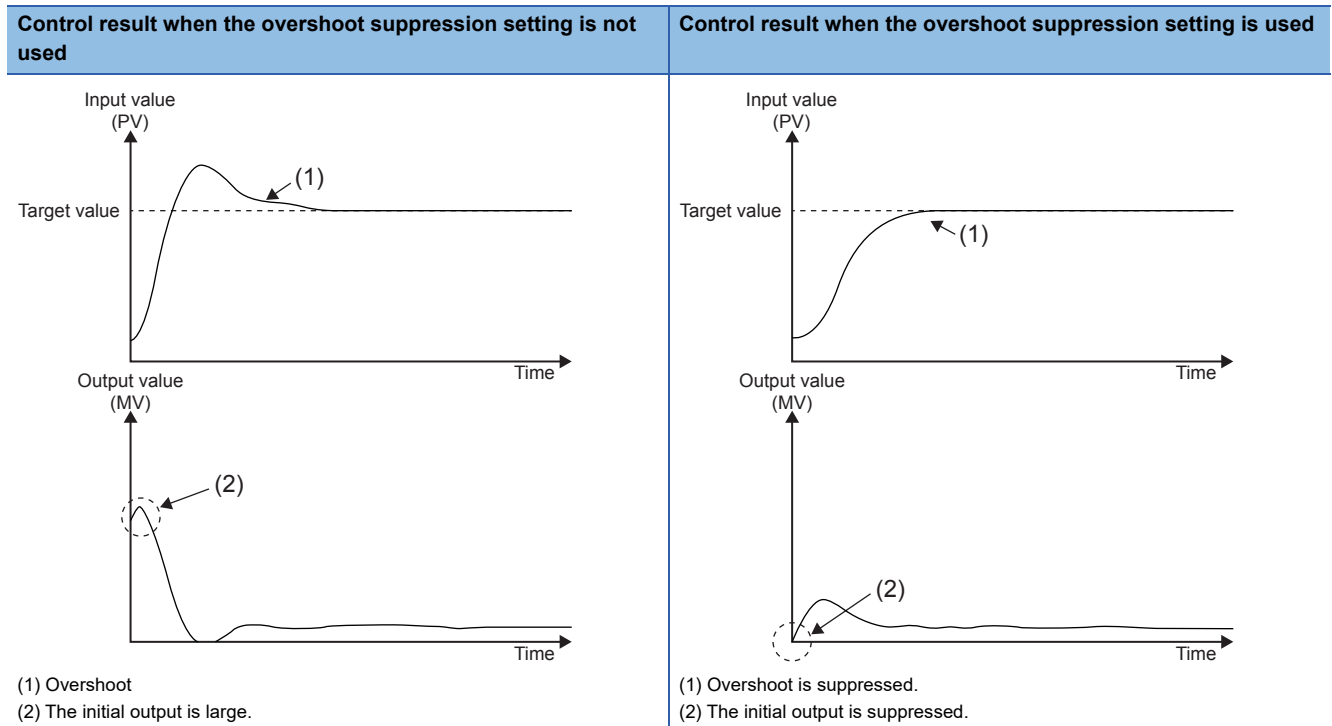

Point

When overshoot remains, suppress overshoot by increasing the integral time.

- Overshoot suppression by increasing the integral time

When overshoot occurs even if the initial output is suppressed by the overshoot suppression setting, increase the integral time ((s3)+4). Overshoot may be suppressed. However, when the integral time is increased excessively, reaching the target value may be delayed or remaining deviation may occur.

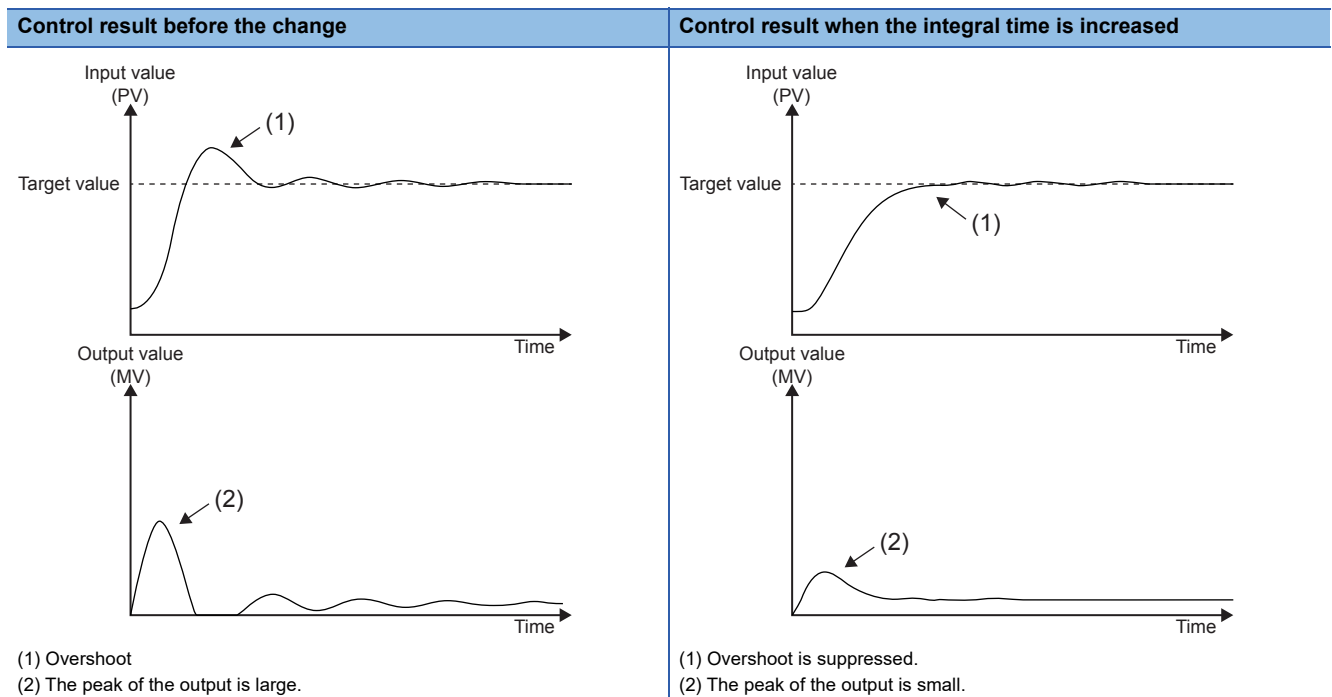

Point

When the first output value is large, use the overshoot suppression setting first.

- Overshoot suppression by using sampling time

When the response speed of the control target is high, shorten the sampling time ((S3)+0) to control finely. Overshoot may be suppressed. However, if the sampling time is too short, it is easily affected by momentary fluctuation of noise.

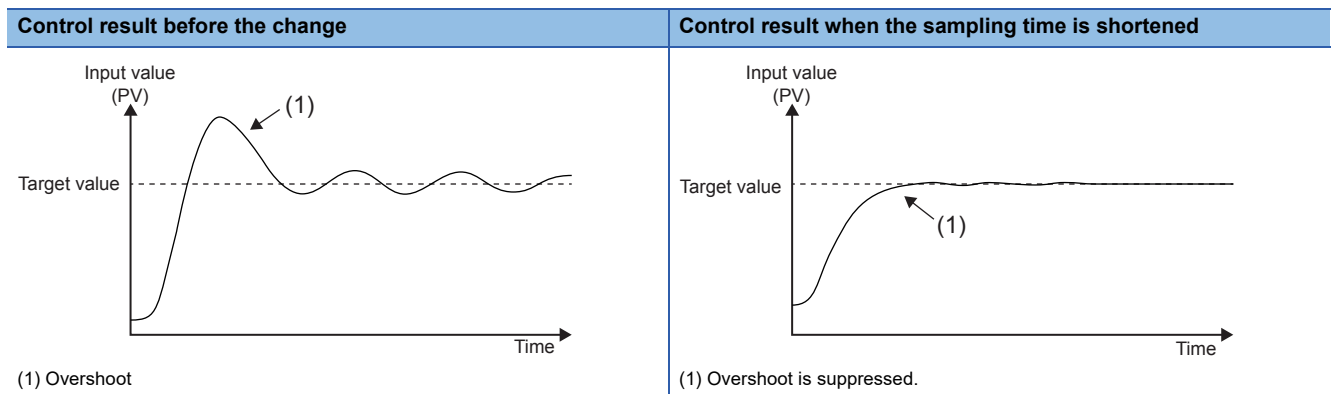

Hunting suppression

When suppressing hunting, the operation is as follows.

■When auto-tuning is executed

When hunting occurs or the output is too large during the PID control using parameters obtained by the step response method, the parameter may be not appropriate because auto tuning is completed before the maximum ramp value that describes characteristics of the control target is obtained correctly.

Change the following setting. The correct maximum ramp value will be obtained and the result may improve.

- Hunting suppression setting

When the maximum ramp value cannot be obtained even if the settings of the sampling time and filter input value are changed, use the hunting suppression setting (turn ON b8 of (S3)+1). Timeout time setting value after maximum ramp detection ((S3)+25) is set so that auto tuning completion caused by a temporary ramp decrease can be avoided. Also, the timeout time (R) after maximum ramp detection setting value varies depending on the response speed of the control target.

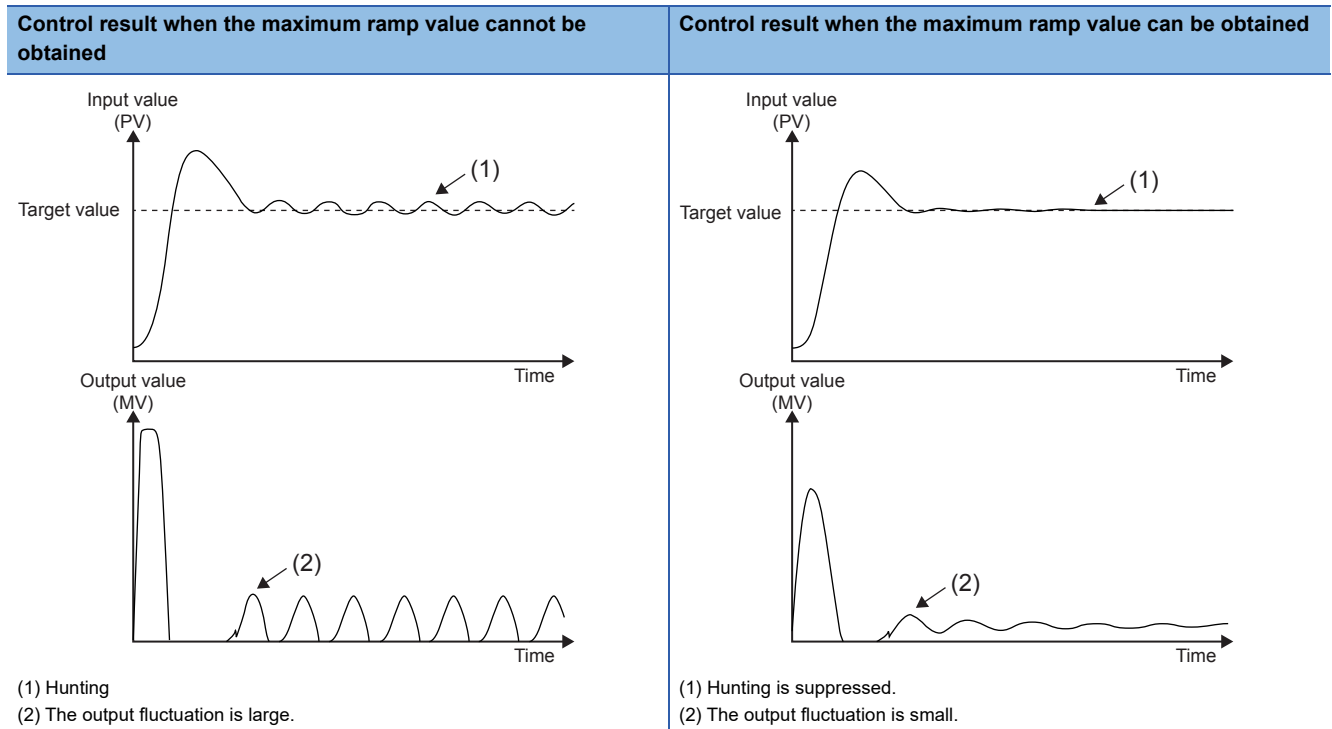

- Sampling time

When the sampling time ((S3)+0) is short, it may be determined that the ramp does not increase because of the difference of the variation between the ON part and OFF part of the output period. Set the sampling time to be not less than the time of output period.

- Input filter value

When the filter input value ((S3)+2) is small, it is easily affected by a temporary ramp decrease caused by noise. Increase the filter input value.

■Auto-tuning is not executed

- Hunting suppression by decreasing the proportional gain

In the following control result case, decrease the proportional gain ((S3)+3). Hunting may be suppressed. However, if the proportional gain is too small, it takes time to reach the target value.

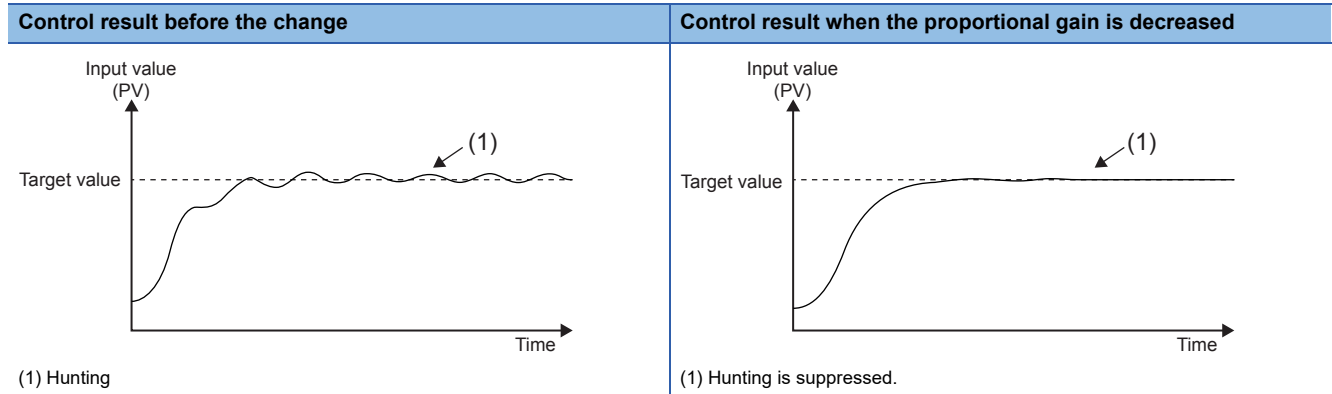

- Hunting suppression by increasing the differential time

In the following control result case, increase the differential time ((S3)+6). Hunting may be suppressed. However, if the differential time is too large, it is easily affected by momentary fluctuation of noise, and the control may be unstable.

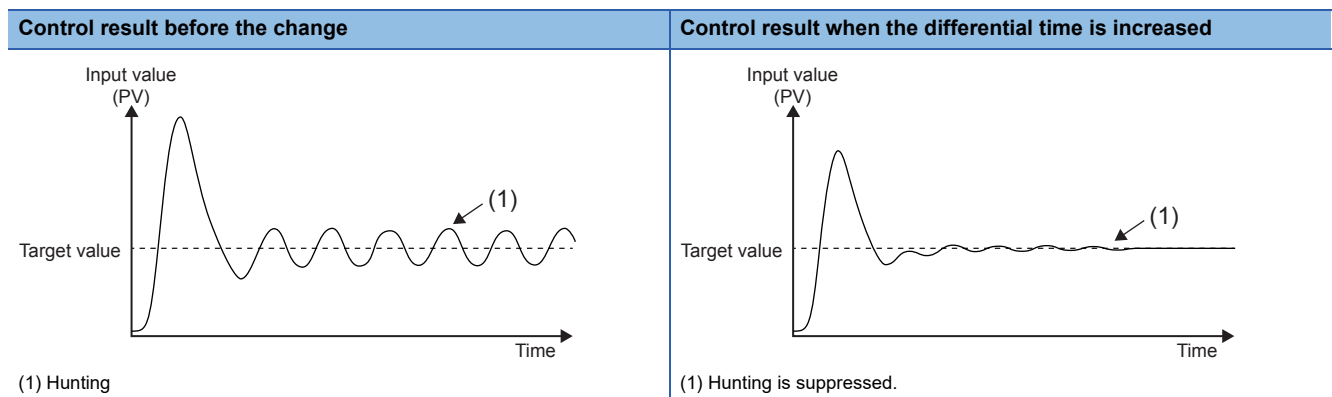

- Hunting suppression time by using the sampling time

When the response speed of the control target is high, shorten the sampling time ((S3)+0) to control finely. Hunting may be suppressed. However, if the sampling time is too short, it is easily affected by momentary fluctuation of noise, and the control may be unstable.

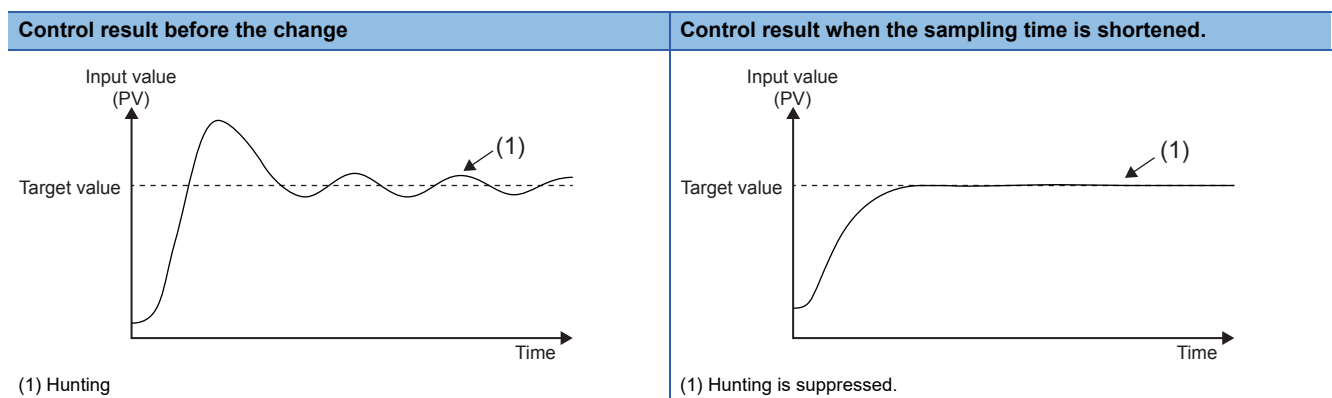

Reduction of remaining deviation

When reducing the remaining deviation, the operation is as follows.

- Remaining deviation according to the input value

When the control result is stable around the target value and the required output value is small, the control result may not converge to the target value because of the influence of noise. In that case, increase the input filter constant $((s+2))$ to suppress the influence of noise. The control result may converge to the target value.

10

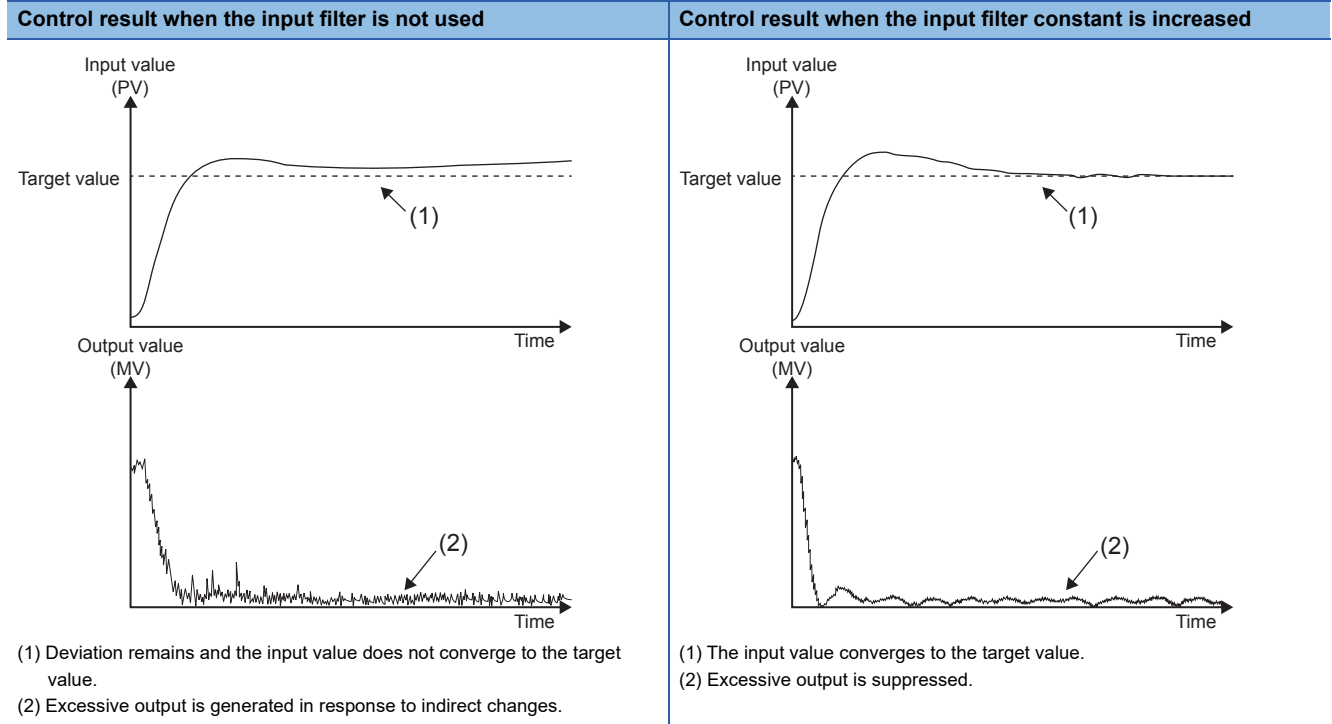

11 CONSTANT SCAN

Since the processing time differs as per the execution/non-execution of command used in the program, the scan timer changes with every scan. By setting the constant scan, because a program can be repeatedly executed while keeping scan time at a specified amount of time, even when the execution time of the program changes, the I/O refresh interval can be constant.

- When constant scan is set (Settings value=10 ms)

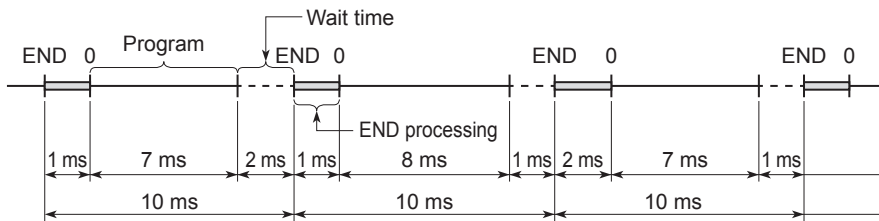

- When constant scan time is not set

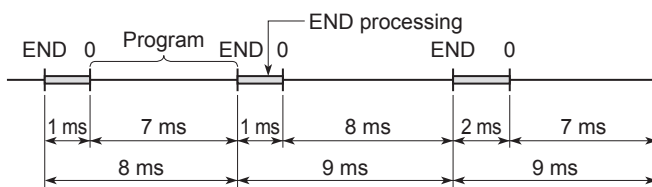

11.1 Constant scan settings

Sets the constant scan setting.

Navigation window ⇒ [Parameter] ⇒ [FX5UJCPU] or [FX5UCPU] ⇒ [CPU Parameter] ⇒ "RAS Setting" ⇒ "Constant Scan Setting"

Window

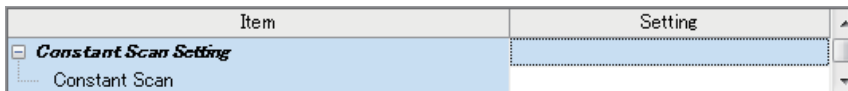

Displayed items

Item	Description	Setting range	Default
Constant Scan	Sets the constant scan time.	<ul style="list-style-type: none"> ■FX5UJ CPU module 0.5 to 2000 ms (0.1 ms units) ■FX5U/FX5UC CPU module 0.2 to 2000 ms (0.1 ms units) 	—

Conditions of setting time

Set a value that meets the following relational equation for the setting time of the constant scan.

"WDT setting time" > "Constant scan setting time" > "Maximum scan time of the program"

When the maximum scan time of the program is longer than the setting time of the constant scan, it results in error. The constant scan time is ignored and it is executed with the scan time of the program.

Ex.

When the constant scan time is set to 4 ms

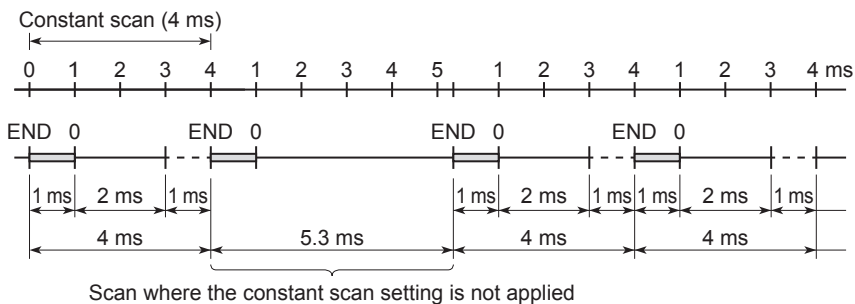

Wait time from the execution of END process until the beginning of the next scan

When there is a processing mentioned below requested during wait time, the processing of the program is interrupted and the corresponding process is carried out.

- Interrupt program
- Event execution type program which triggers the generation of interruption
- Device/label access service processing

12 REMOTE OPERATION

A remote operation is an operation to externally change the operation status of the CPU module with the RUN/STOP/RESET switch of the CPU module set to the RUN position.

The following items show the types of remote operation.

- Remote RUN/STOP
- Remote PAUSE
- Remote RESET

12.1 Remote RUN/STOP

This operation externally changes the CPU module to RUN/STOP status with the RUN/STOP/RESET switch of the CPU module set to the RUN position. It is used to reach a CPU module in an inaccessible place or in case of changing the status of the CPU module in the control box to RUN/STOP status with an external signal.

Applications of remote RUN/STOP

It is usable in the following cases.

- When the CPU module is in an inaccessible place
- When changing the status of the CPU module in the control box to RUN/STOP from outside

Operation during remote RUN/STOP

In case of remote RUN/STOP, the operation of the program is as shown below.

At remote STOP

A program is executed up-to END instruction and changes to STOP status.

At remote RUN

When remote RUN is executed in the STOP status, once again the CPU module turns to RUN status and the program is executed from step 0.

Method of execution of remote RUN/STOP

The following are the methods of execution of remote RUN/STOP.

Contact method

Set the RUN contact in the parameter. The allowable device range is X0 to X17.

Execute remote RUN/STOP by contact ON/OFF. Set the correspondence of ON/OFF and RUN/STOP operation of the contact in CPU parameters.

- When set to RUN at contacts ON

When contact is set to OFF, the CPU module is in the STOP status.

When contact is set to ON, the CPU module is in the RUN status.

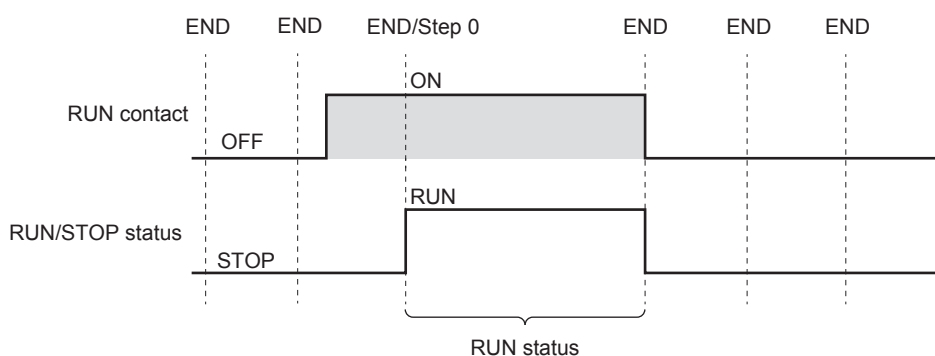

- When set to RUN at contacts OFF

When contact is set to OFF, the CPU module is in the RUN status.

When contact is set to ON, the CPU module is in the STOP status.

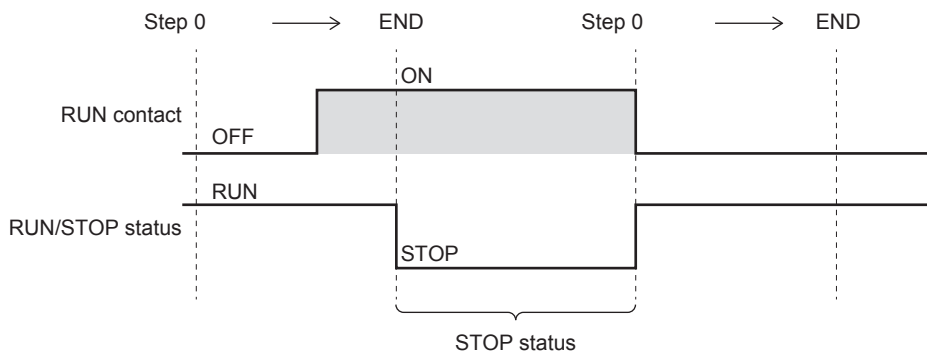

Engineering tool method

Refer to the following.

📖 GX Works3 Operating Manual

Method using external devices that use SLMP or MC protocol

Execute by SLMP or MC protocol 1C/3C/4C frame command. For details on commands, refer to the following manual.

📖 MELSEC iQ-F FX5 User's Manual (SLMP)

📖 MELSEC iQ-F FX5 User's Manual (MELSEC Communication Protocol)

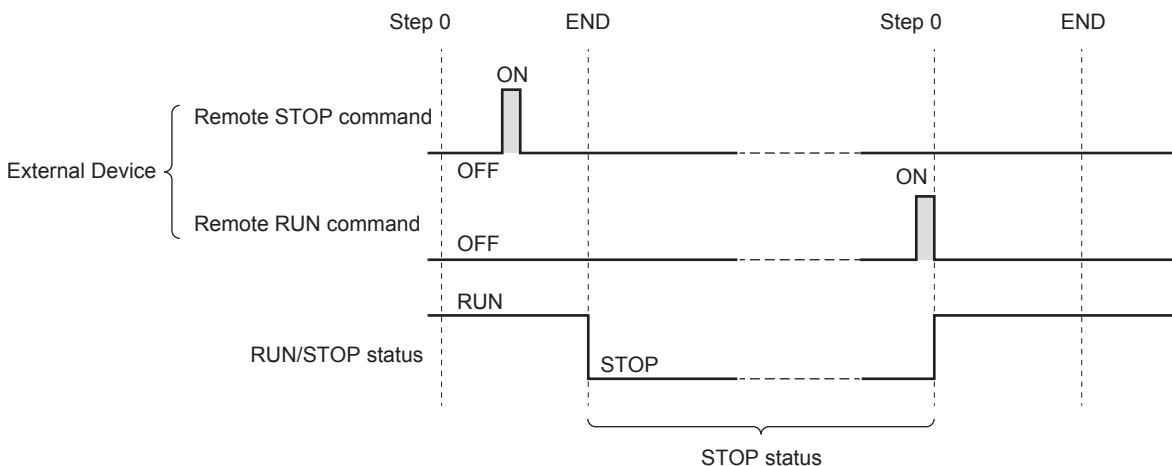

Precautions

Describes the precautions on using remote RUN/STOP.

- When remote RUN is performed during execution of the data logging function, it may fail. In that case, wait for a while and retry remote RUN. If remote RUN still cannot be executed, check whether remote RUN is acceptable and retry remote RUN. (📖 Page 175 About remote operation)
- When remote STOP to RUN operation of the RUN contact during execution of the data logging function, it may take time to return to the RUN state.

12.2 Remote PAUSE

With the RUN/STOP/RESET switch set to the RUN position of the CPU module, the operation status is changed to PAUSE status from outside. The PAUSE status is a status in which operation of the CPU module is stopped by holding the ON/OFF status of all output (Y).

Application of remote PAUSE

Remote PAUSE can be used to hold the output (Y) turned ON when the CPU module is in the RUN status, in the same ON status, even when the CPU module is changed to STOP status.

Method of execution of remote PAUSE

The following are the methods of execution of remote PAUSE.

Engineering tool method

Refer to the following.

📖 GX Works3 Operating Manual

Method using external devices that use SLMP or MC protocol

Execute by SLMP or MC protocol 3C/4C frame command. For details on commands, refer to the following manual.

📖 MELSEC iQ-F FX5 User's Manual (SLMP)

📖 MELSEC iQ-F FX5 User's Manual (MELSEC Communication Protocol)

- Turns ON the PAUSE contact (SM204) when executing the END process of the scan that has received the remote PAUSE command. When a PAUSE contact is turned ON and the next scan is executed up-to the END process, the CPU module enters the PAUSE status and operation is stopped.
- When a remote RUN command is received, once again an operation of the sequence program is executed from step 0.

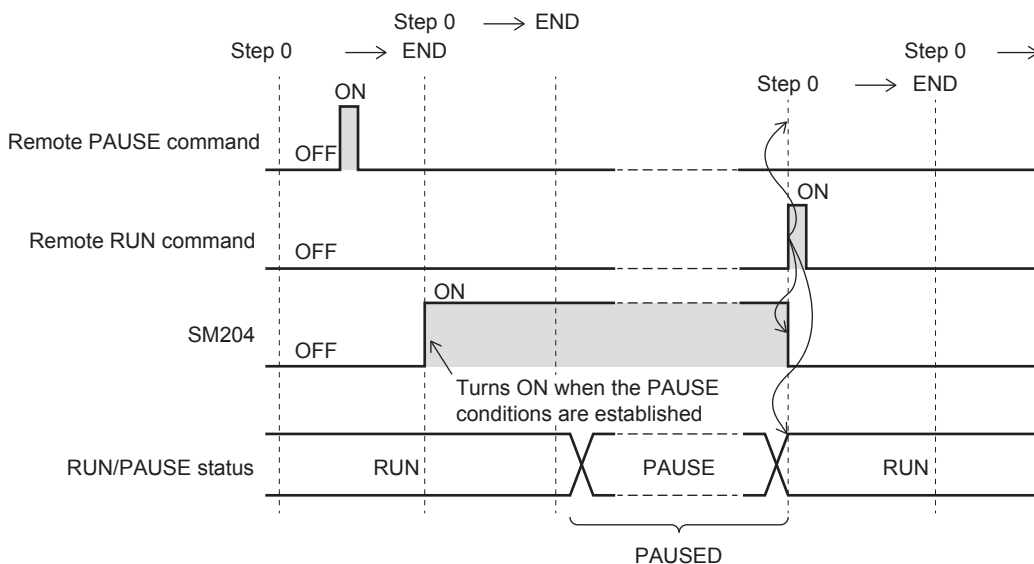

Precautions

■When keeping in forced ON or OFF status in advance

When keeping in forced ON or OFF status in advance, interlock using the PAUSE contact (SM204).

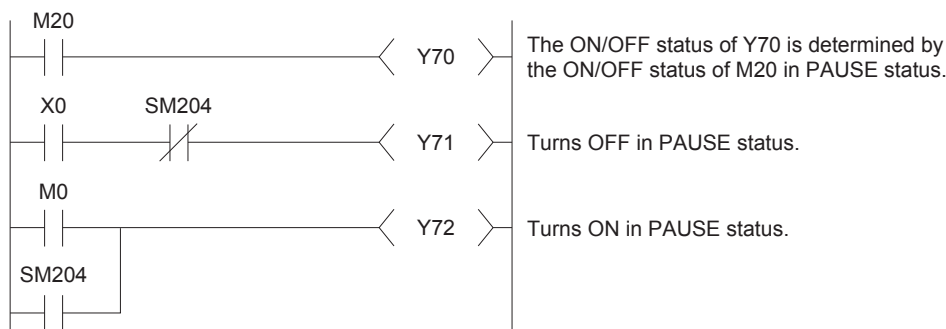

12.3 Remote RESET

This is an operation to reset the CPU module by an external operation when the CPU module is in the STOP status. In addition, even if the RUN/STOP/RESET switch of the CPU module is set to RUN position, reset is possible when the CPU module has stopped due to occurrence of an error that can be detected by self-diagnosis function.

Application of remote RESET

When a CPU module is in an inaccessible place and an error has occurred, CPU module can be reset by a remote operation.

Enabling remote RESET

To remotely RESET, remote RESET must be enabled.

Navigation window ⇒ [Parameter] ⇒ [FX5UJCPU] or [FX5UCPU] ⇒ [CPU Parameter] ⇒ "Operation Related Setting" ⇒ "Remote Reset Setting"

Window

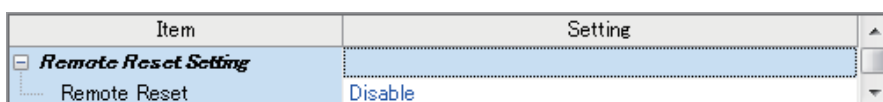

Displayed items

Item	Description	Setting range	Default
Remote Reset	Set whether or not to enable remote RESET.	<ul style="list-style-type: none"> Disable Enable 	Disable

Method of execution of remote RESET

The following are the methods of execution of remote RESET.

Engineering tool method

Refer to the following.

📖 GX Works3 Operating Manual

Method using external devices that use SLMP or MC protocol

Execute by SLMP or MC protocol 3C/4C frame command. For details on commands, refer to the following manual.

📖 MELSEC iQ-F FX5 User's Manual (SLMP)

📖 MELSEC iQ-F FX5 User's Manual (MELSEC Communication Protocol)

Point

When executing remote RESET, the settings that allow the remote reset of the CPU parameter must be written to CPU module beforehand. In the case that they are not set, remote RESET will not be possible.

Precautions

■ Remote RESET in RUN status

When the CPU module is in RUN status, it cannot be reset by remote RESET. Change the CPU module to STOP status by operations like remote STOP and then execute remote RESET.

■ State after completion of the reset process

When the reset process is completed on a CPU module on which remote RESET was executed, the CPU module will change to an operation status set by the RUN/STOP/RESET switch. Setting the RUN/STOP/RESET switch to the STOP position, will change the status to STOP and setting the switch to the RUN position will change the status to RUN.

Point

- Note that if a remote RESET is executed when the CPU module has stopped due to an error, the CPU module will change to an operation status set by the RUN/STOP/RESET switch, by reset process completion.
- If status of CPU module does not change even after executing remote RESET by engineering tool, check the remote reset settings in the CPU parameter. If it is not set, even after completion of the remote process of engineering tool, reset process of the CPU module will not be carried out.

■ When an error occurs due to noise

When there an error due to noise, exercise caution as there is a possibility that PLC cannot be reset by remote RESET. When reset by remote RESET is not possible, either execute reset by RUN/STOP/RESET switch or once again start up the power of CPU module.

12.4 Relationship Between Remote Operation and CPU Module

Relationship between remote operation and RUN/STOP status of the CPU module

The following table shows operation status of the CPU module by the combination of remote operation and RUN/STOP status of the CPU module.

Switch RUN/STOP status	Remote operation			
	RUN ^{*1}	STOP	PAUSE	RESET ^{*2}
RUN	RUN	STOP	PAUSE	Operation not possible ^{*3}
STOP	STOP	STOP	STOP	RESET ^{*4}

*1 When executing by the RUN contact, setting of RUN contact is required in the CPU parameter.

*2 Remote reset setting is required in the CPU parameter.

*3 When a CPU module is changed to STOP status by a remote operation, remote reset is possible.

*4 Includes even the cases where CPU module has stopped due to an error.

13 DEVICE/LABEL MEMORY AREA SETTING

The capacity of each area in device/label memory can be specified.

Only FX5U/FX5UC CPU module is supported.

For FX5UJ CPU module, the setting cannot be changed but the content can be checked.

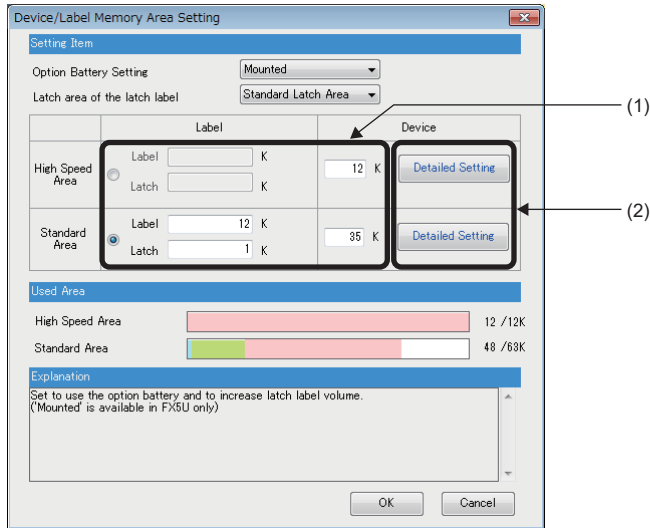

Item	Symbol	Device		Latch (1)	Latch (2)
		Points	Range		
Input	X	1024	0 to 1777		
Output	Y	1024	0 to 1777		
Internal Relay	M	7680	0 to 7679	Setting	No Setting
Link Relay	B	256	0 to FF	No Setting	No Setting
Link Special Relay	SB	512	0 to 1FF		
Annunciator	F	128	0 to 127	No Setting	No Setting
Step Relay	S	4096	0 to 4095	Setting	
Timer	T	512	0 to 511	No Setting	No Setting
Retentive Timer	ST	16	0 to 15	Setting	No Setting
Counter	C	256	0 to 255	Setting	No Setting
Long Counter	LC	64	0 to 63	Setting	No Setting
Data Register	D	8000	0 to 7999	Setting	No Setting
Latch Relay	L	7680	0 to 7679		
Area Capacity			12.0K Word		11.0K Word
Total Device			11.9K Word		9.6K Word
Total Word Device			10.2K Word		8.1K Word
Total Bit Device			27.9K Bit		25.1K Bit

(1) The capacity of each area can be changed. (☞ Page 123 Device/Label Memory Area Setting)

(2) The number of points of user devices can be changed. (☞ Page 124 Device Setting)

13.1 Default Capacity of Each Area

The default capacity of each area is as follows.

Item	Capacity
Device (high speed) Area Capacity	12 K words
Device (standard) Area Capacity	35 K words
Label Area Capacity	12 K words
Latch Label Area Capacity	1 K words

13.2 The Setting Range of the Capacity of Each Area

The setting range of the capacity of each area on the device/label memory is as follows.

Item	Setting range of capacity of each area
Device (high speed) Area Capacity	0 to 12 K words
Device (standard) Area Capacity	0 to 63 K ^{*1} words
Label Area Capacity	0 to 63 K ^{*1} words
Latch Label Area Capacity	0 to 63 K ^{*1} words

*1 For supported version, refer to  Page 566 Added and Enhanced Functions.

Restriction of a label/latch label area capacity

■When device area setting using by label/latch label is standard area

Label Area Capacity + Latch Label Area Capacity + Device (standard) Area Capacity \leq 63 K^{*1} Word (1 K word unit)

■When device area setting using by label/latch label is high speed area

Label Area Capacity + Latch Label Area Capacity + Device (high speed) Area Capacity \leq 12 K Word (1 K word unit)

■When FB is used

When using FB, the reserved area for adding labels other than the labels defined for FB will be used.

The following capacities are consumed per FB instance.

Label area: 48 words

Latch area: 16 words

*1 For supported version, refer to  Page 566 Added and Enhanced Functions.

13.3 Device/Label Memory Area Setting

The capacity of each data area allocated within the device/label memory can be changed.

Navigation window ⇒ [Parameter] ⇒ [FX5UCPU] ⇒ [CPU Parameter] ⇒ "Memory/Device Setting" ⇒ "Detailed Setting" ⇒ "Device/Label Memory Area Setting" screen

Operating procedure

"Device/Label Memory Area Setting" window

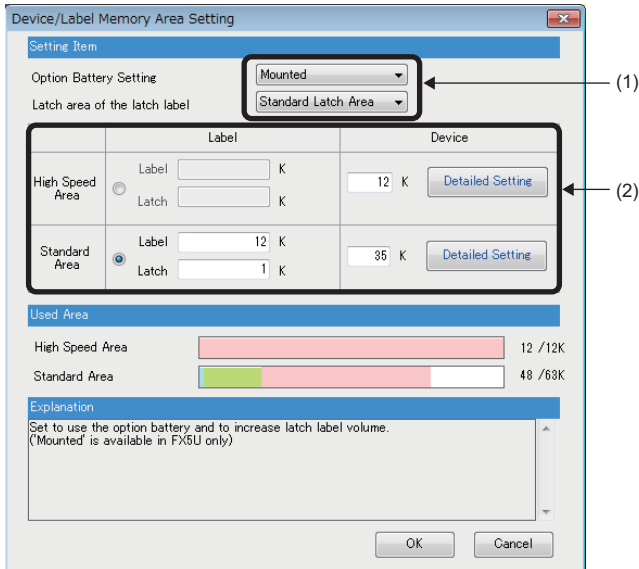

1. In "Option Battery Setting", select whether or not to use a option battery.
2. In "Device/Label Memory Area Setting" screen, set the capacity of each area.

Displayed items

(1) Whether or not to use an option battery, and latch area setting for the latch type label can be changed.

Items	Description	Setting range	Default
Option Battery Setting	Set when using option battery. The points which can be held can be increased by this setup.	<ul style="list-style-type: none"> • Not Mounted • Mounted 	Not Mounted
Latch area of the latch label	The latch device of standard area can be held with a battery. The latch area of latch label can be changed to battery latch area from standard latch area (nonvolatile memory).	<ul style="list-style-type: none"> • Standard Latch Area • Battery Latch Area 	Standard Latch Area

(2) The device/label memory area capacity can be set.

Items	Label	Device
High-speed Area	Label: Set label area capacity used in the global label, local label.*1	Set the capacity of device (standard) area. The number of device points in the detail settings, and the latch settings can be changed. For details, refer to Page 124 Device Setting.
Standard Area	Latch: Set the latch label area capacity used for the latch type label.*1	

*1 For details on the setting range for each area capacity, refer to Page 122 The Setting Range of the Capacity of Each Area.

Point

High-speed area: Area which can be accessed at high speed. Latch is always held by nonvolatile memory.
 Standard area: Area which can be held when option battery is used. In addition, about a latched type label, when a latch area is set as a standard latch area, latch type label is held by nonvolatile memory.

13.4 Device Setting

The number of points of each user device can be changed.

Navigation window ⇒ [Parameter] ⇒ [FX5UCPU] ⇒ [CPU Parameter] ⇒ "Memory/Device Setting" ⇒ "Device/Label Memory Area Setting" ⇒ "Device/Label Memory Area Detailed Setting" ⇒ "Device (high speed) Setting/Device (standard) Setting"

Window

"Device (high speed) Setting" details window

Item	Symbol	Device		Latch (1)	Latch (2)
		Points	Range		
Input	X	1024	0 to 1777		
Output	Y	1024	0 to 1777		
Internal Relay	M	7680	0 to 7679	Setting	No Setting
Link Relay	B	256	0 to FF	No Setting	No Setting
Link Special Relay	SB	512	0 to 1FF		
Annunciator	F	128	0 to 127	No Setting	No Setting
Step Relay	S	4096	0 to 4095	Setting	
Timer	T	512	0 to 511	No Setting	No Setting
Retentive Timer	ST	16	0 to 15	Setting	No Setting
Counter	C	256	0 to 255	Setting	No Setting
Long Counter	LC	64	0 to 63	Setting	No Setting
Data Register	D	8000	0 to 7999	Setting	No Setting
Latch Relay	L	7680	0 to 7679		
Area Capacity		12.0K Word		11.0K Word	
Total Device		11.9K Word		9.6K Word	
Total Word Device		10.2K Word		8.1K Word	
Total Bit Device		27.9K Bit		25.1K Bit	

"Device (standard) Setting" details window

Item	Symbol	Device		Latch (1)	Latch (2)
		Points	Range		
File Register	R	32768	0 to 32767	No Setting	No Setting
Link Register	W	512	0 to 1FF	No Setting	No Setting
Link Special Register	SW	512	0 to 1FF		
Area Capacity		35.0K Word		----	
Total Device		33.0K Word		0.0K Word	
Total Word Device		33.0K Word		0.0K Word	
Total Bit Device		0.0K Bit		0.0K Bit	

Point

Specify each item so that the total number of points for each user device does not exceed the capacity of the device area. (☞ Page 123 Device/Label Memory Area Setting)

Range of use of device points

The following table lists the range of use of device points to be set in the device setting.

Device (high speed) Setting

■FX5UJ CPU module

Type	Device name	Symbol	Range of use	Increment of setting
Bit	Input	X	X0 to X1777	—
Bit	Output	Y	Y0 to Y1777	—
Bit	Internal relay	M	M0 to M7679	—
Bit	Link relay	B	B0 to B7FF	—
Bit	Link special relay	SB	SB0 to SB7FF	—
Bit	Annunciator	F	F0 to F127	—
Bit	Step relay	S	S0 to S4095	—
Word	Timer	T	T0 to T511	—
Word	Retentive timer	ST	ST0 to ST15	—
Word	Counter	C	C0 to C255	—
Word	Long counter	LC	LC0 to LC63	—
Word	Data register	D	D0 to D7999	—
Bit	Latch relay	L	L0 to L7679	—

■FX5U/FX5UC CPU module

Type	Device name	Symbol	Range of use	Increment of setting
Bit	Input	X	X0 to X1777	—
Bit	Output	Y	Y0 to Y1777	—
Bit	Internal relay	M	M0 to M32767	64 points
Bit	Link relay	B	B0 to B7FFF	64 points
Bit	Link special relay	SB	SB0 to SB7FFF	64 points
Bit	Annunciator	F	F0 to F32767	64 points
Bit	Step relay	S	S0 to S4095	—
Word	Timer	T	T0 to T1023	16 points
Word	Retentive timer	ST	ST0 to ST1023	16 points
Word	Counter	C	C0 to C1023	16 points
Word	Long counter	LC	LC0 to LC1023	16 points
Word	Data register	D	D0 to D7999	4 points
Bit	Latch relay	L	L0 to L32767	64 points

Device (standard) Setting

■FX5UJ CPU module

Type	Device name	Symbol	Range of use	Increment of setting
Word	File registers	R	R0 to R32767	—
Word	Link register	W	W0 to W3FF	—
Word	Link special register	SW	SW0 to SW3FF	—

■FX5U/FX5UC CPU module

Type	Device name	Symbol	Range of use	Increment of setting
Word	File registers	R	R0 to R32767	4 points
Word	Link register	W	W0 to W7FFF	4 points
Word	Link special register	SW	SW0 to SW7FFF	4 points



Extended file register (ER) is the device held only in the SD memory card. The device setting is not required for a extended file register (ER), and range of use is ER0 to ER32767.

14 PROGRAM CAPACITY SETTING

Set to change program capacity.

Only FX5U/FX5UC CPU module is supported. For supported version of program capacity setting, refer to  Page 566 Added and Enhanced Functions.

 Navigation window ⇒ [Parameter] ⇒ [FX5UCPU] ⇒ [CPU Parameter] ⇒ "Program Setting" ⇒ "Program Capacity Setting"

Window

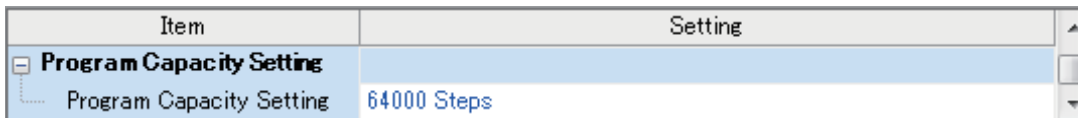

Item	Setting
Program Capacity Setting	
Program Capacity Setting	64000 Steps

Displayed items

Item	Description	Setting range	Default
Program Capacity Setting	Set to change program capacity.	<ul style="list-style-type: none">• 64000 Steps• 128000 Steps	64000 Steps

14

Precautions

If 128000 steps is selected, the operation is changed as follows.

- Signal flow^{*1} area for FB is expanded from 16K bytes to 32K bytes.
- Temporary area capacity is expanded from 700 words to 32767 words.
- Execution time for each instruction is prolonged.

Do not write a program with more than 64000 steps to the CPU module firmware version earlier than "1.100". The program does not operate normally.

*1 Signal flow: The execution status that the last time an operation of a program or an FB is executed in each step.

15 INTERNAL BUFFER CAPACITY SETTING

Configure the capacity of an area (internal buffer) that the system consumes to temporarily store the result of data logging and the collection result of memory dump. When using the data logging function, adjusting the internal buffer capacity allows an increase in the number of collected data and reduces the risk of processing overflow.

Navigation window ⇒ [Parameter] ⇒ [FX5UJCPU] or [FX5UCPU] ⇒ [CPU Parameter] ⇒ "Memory/Device Setting" ⇒ "Internal Buffer Capacity Setting"

Window

Item	Setting
Internal Buffer Capacity Setting	
Total Capacity	320 K Byte
Function to Use Internal Buffer	Data Logging Function
Data Logging Function	
Total Capacity	320 K Byte
Setting No.1	80 K Byte
Setting No.2	80 K Byte
Setting No.3	80 K Byte
Setting No.4	80 K Byte
Memory Dump Function	0 K Byte

Displayed items

Item	Description	Setting range	Default
Total Capacity	Shows the total of the internal buffer capacity set in the data logging function or the memory dump function.	<ul style="list-style-type: none"> ■FX5UJ CPU module <ul style="list-style-type: none"> • 320K bytes (fixed) ■FX5U/FX5UC CPU module <ul style="list-style-type: none"> • 0 to 320K bytes 	320K bytes
Function to Use Internal Buffer	Set the function to use the internal buffer.	<ul style="list-style-type: none"> • Data Logging Function • Memory Dump Function 	Data Logging Function
Data Logging Function	Total Capacity	—	320K bytes
	Setting No. 1 to 4	<ul style="list-style-type: none"> ■FX5UJ CPU module <ul style="list-style-type: none"> • Each setting range: 80K bytes (fixed) • Total setting range: 320K bytes (fixed) ■FX5U/FX5UC CPU module <ul style="list-style-type: none"> • Each setting range: 32 to 320K bytes (in 1K bytes)^{*1*2} • Total setting range: 32 to 320K bytes 	80K bytes
Memory Dump Function	Set the internal buffer capacity used for the memory dump function.	192K bytes (fixed) ^{*2}	192K bytes

*1 0 K byte (fixed) when using memory dump function.

*2 0 K byte (fixed) when using data logging function.

Point

The internal buffer is also consumed by the real-time monitor function. The internal buffer capacity consumed by the real-time monitor function is 64 K byte (fixed).

Restriction

For supported version of FX5U/FX5UC CPU module internal buffer capacity setting, refer to  Page 566 Added and Enhanced Functions.

16 INITIAL DEVICE VALUE SETTING

Directly sets the initial value of a device used by the program (i.e., not via the program).

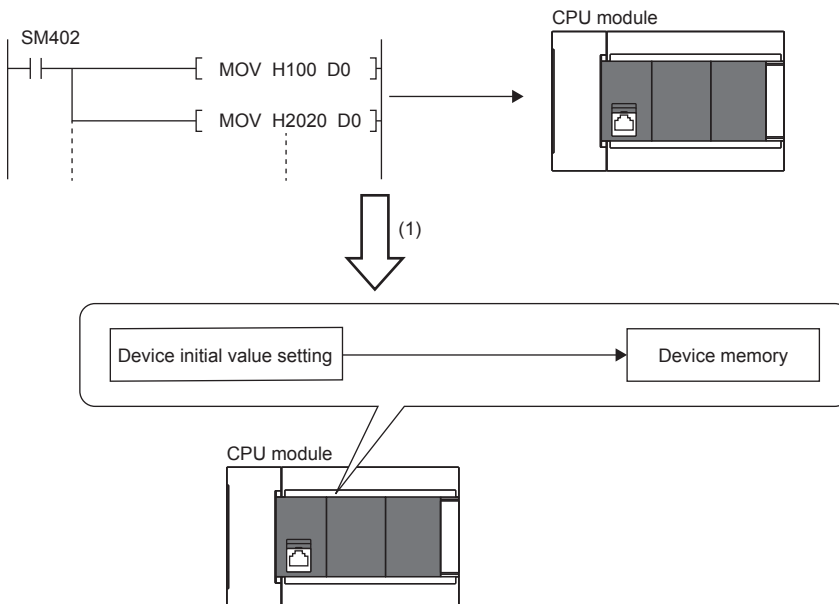

(1) If initial device values are used, a program to set data to the devices becomes unnecessary.

16.1 Setting Initial Device Values

This section describes the settings required to use initial device values.

Setting initial device values

This section describes the settings of initial device values.

Setting procedure

The procedure for using initial device values is as follows.

1. First, the user must create an initial device value file. To set initial values to a global device, create an initial device value file (with any name) which sets these initial values, and specify the range of the values.
2. On the device memory, set up initial device value data within the range specified in the initial device value file.
📖 GX Works3 Operating Manual
3. In the "Device Memory Register Diversion", select the device memory which was set up in Step 2. Setting "Device Memory Register Diversion" enables data set up on the device memory to be used as initial device values for the device which is specified in the initial device value file.
📖 GX Works3 Operating Manual
4. Configure CPU parameters. (📖 Page 131 Initial value setting)
5. Write the set initial device value file and the CPU parameters to the CPU module.
📖 GX Works3 Operating Manual
6. The data in the specified initial device value file is automatically set to the specified device when the CPU module is powered off and on, reset, or the status changes from STOP to RUN.

Initial value setting

Configure the initial value setting.

Navigation window ⇒ [Parameter] ⇒ [FX5UJCPU] or [FX5UCPU] ⇒ [CPU Parameter] ⇒ "File Setting" ⇒ "Initial Value Setting"

Window

Item	Setting
Initial Value Setting	
Setting of Device Initial Value Use Or Not	Not Use
Target Memory	Data Memory
Global Device Initial Value File Name	

Displayed items

Item	Description	Setting range	Default
Setting of Device Initial Value Use Or Not	Sets whether or not to use initial device values.	<ul style="list-style-type: none">Not UseUse	Not Use
Target Memory	Sets the storage memory for the initial device value file.	<ul style="list-style-type: none">Memory cardData Memory	Data Memory
Global Device Initial Value File Name	Sets the name of the initial global device value file.*1	60 characters or less	—

*1 If nothing is specified, initial global device values are not applied.

Number of initial device value settings and maximum range of one range

Up to 1000 ranges can be set in one initial device value file. Up to 8000 data points can be set in one range.

16.2 Applicable Devices

For details on devices to which initial device/label values can be set, refer to the following.

 GX Works3 Operating Manual

17 LATCH FUNCTION

The contents of each device/label of the CPU module is cleared in the cases described below and changed to its default value.

- At power OFF→ON of the CPU module
- At reset
- A power failure that exceeded allowable momentary power interruption

The contents of each device/label with latch setting will be maintained in case of power failure even in the above-mentioned cases. Therefore, when the data is managed by continuous control, even if power of the CPU is turned OFF or there is a power failure that exceeds the allowable momentary power interruption, all data can be maintained and control can be continued.

17.1 Types of Latch

There are two types of latches, latch (1) and latch (2).

Latch clear range can be set by selecting latch (1) or latch (2).

For latch clearing, refer to  Page 135 Clearing of Data of the Latch Range.

17.2 Device/label that can be Latched

The devices and labels that can be latched are described below.

The devices that can be latched

The devices that can be latched are described below.

■FX5UJ CPU module

Device	Specification Method	Applicable latch type
Internal relay (M)	The latch range is fixed. The latch range cannot be changed.	Latch (1) only
Latch relay (L)	The latch range is fixed. The latch range cannot be changed.	Latch (1) only
Annunciator (F)	The latch range is fixed. The latch range cannot be changed.	Latch (1) only
Step relay (S)	The latch range is fixed. The latch range cannot be changed.	Latch (1) only
Accumulation timer (ST)	The latch range is fixed. The latch range cannot be changed.	Latch (1) only
Counter (C)/Long counter (LC)	The latch range is fixed. The latch range cannot be changed.	Latch (1) only
Data register (D)	The latch range is fixed. The latch range cannot be changed.	Latch (1) only
Extended file register (ER)	The latch setting is not required because extended file register (ER) is the device held only in the SD memory card. (All latch points fixed)	—

■FX5U/FX5UC CPU module

Device	Specification Method	Applicable latch type
Internal relay (M)	Specify the latch range	Latch (1) or Latch (2)
Latch relay (L)	Specify the number of points	Latch (1) or Latch (2)
Link relay (B)	Specify the latch range	Latch (1) or Latch (2)
Annunciator (F)	Specify the latch range	Latch (1) or Latch (2)
Step relay (S)	Specify the latch range	Latch (1) only
Timer (T)/Accumulation timer (ST)	Specify the latch range	Latch (1) or Latch (2)
Counter (C)/Long counter (LC)	Specify the latch range	Latch (1) or Latch (2)
Data register (D)	Specify the latch range	Latch (1) or Latch (2)
Link register (W) ^{*1}	Specify the latch range	Latch (1) or Latch (2)
File register (R) ^{*1}	Specify the latch range	Latch (1) or Latch (2)
Extended file register (ER)	The latch setting is not required because extended file register (ER) is the device held only in the SD memory card. (All latch points fixed)	—

*1 Link register (W) and file register (R) can be latched only when an optional battery is used.

Labels that can be latched

The labels that can be latched are described below.

Label	Type	Attribute	Data type
Global label	VAR_GLOBAL	RETAIN	Basic data type, array, structure
Local label of the program block	VAR		
Local label of the Function Block	VAR		
	VAR_OUTPUT		
	VAR_PUBLIC		

17.3 Latch Settings

Latch settings

This subsection describes the latch setting.
Only FX5U/FX5UC CPU module is supported.

Setting latch on devices

A range of multiple latches can be set for 1 type of device. Two latch ranges, latch (1) and latch (2), can be set. However, make sure that the range of latch (1) and latch (2) is not overlapping.

■Latch range setting

Set the device to latch, its range, and the latch type.

Operating procedure

"Device Setting" window

Item	Symbol	Device		Latch (1)	Latch (2)
		Points	Range		
Input	X	1024	0 to 1777		
Output	Y	1024	0 to 1777		
Internal Relay	M	7680	0 to 7679	Setting	No Setting
Link Relay	B	256	0 to FF	No Setting	No Setting
Special Link Rela	SB	256	0 to FF		
Annunciator	F	128	0 to 127	No Setting	No Setting
Step Relay	S	4096	0 to 4095	Setting	
Timer	T	512	0 to 511	No Setting	No Setting
Retentive Timer	ST	16	0 to 15	Setting	No Setting
Counter	C	256	0 to 255	Setting	No Setting
Long Counter	LC	64	0 to 63	Setting	No Setting
Data Register	D	8000	0 to 7999	Setting	No Setting
Latch Relay	L	7680	0 to 7679		
Total Device			11.1K Word		9.6K Word
Total Word Device			10.2K Word		8.1K Word
Total Bit Device			15.7K Bit		25.1K Bit

"Latch Range Setting" window

Latch (1)		Latch (2)		
No.	Device	Points (Decimal)	Start	End
1	M	7180	500	7679
2	S	3596	500	4095
3	ST	16	0	15
4	C	100	100	199
5	LC	44	20	63
6	D	7800	200	7999
7				
8				
9				
10				
11				
12				
13				

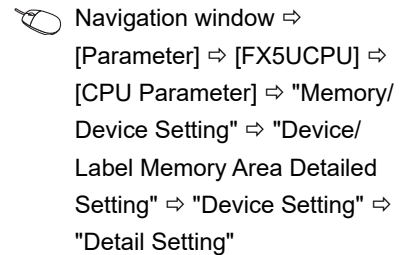
1. Click "Detailed Setting" on the "Device Setting".
2. On the "Device Setting" window, select the type of latch for the target device. Then, the "Latch Range Setting" window is displayed.

3. Check the tab for the latch type, select the device to set and set the latch range (Start, End).

Setting latch on labels

This subsection describes latch setting on labels.

Operating procedure

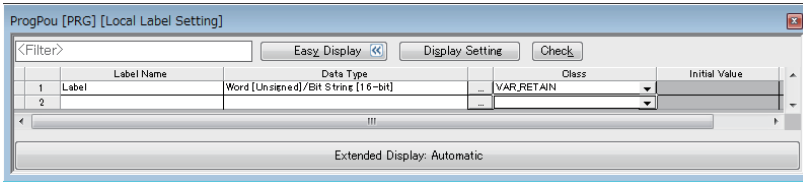
Label edit window



"Device/Label Memory Area Detailed Setting" window

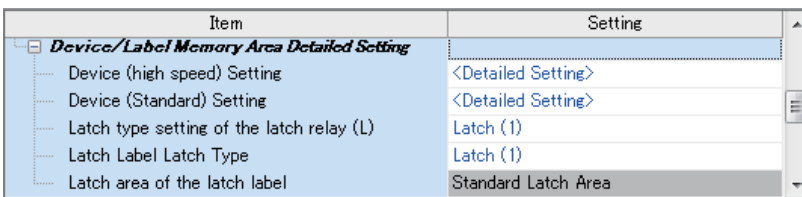

1. In the label edit window, specify "RETAIN" for label attribute.
2. There are two types of latch for labels: latch (1) and latch (2). Select one. The selected latch type is applied to all labels of with latch attribute.
 - Navigation window ⇒ [Parameter] ⇒ [FX5UCPU] ⇒ [CPU Parameter] ⇒ "Memory/Device Setting" ⇒ "Device/Label Memory Area Detailed Setting" ⇒ "Latch Label Latch Type"

17.4 Clearing of Data of the Latch Range

The data of the latch range can be cleared by the following ways.

Method of latch clearing

By using engineering tools. (GX Works3 Operating Manual)

[Online] ⇒ [CPU memory operation]

The range cleared can be selected by performing CPU memory operation.

- Clear the devices outside the latch range.
- Clear the devices outside the latch range and the devices within the range of latch (1).
- Clear the devices outside the latch range, the devices within the range of latch (1) and the devices within the range of latch (2).

Method of clearing by program

■ Clearing by program

Execute an RST command to a latched device or clear by sending K0 in MOV/FMOV instructions.

■ Clearing by special relay (SM8031 or SM8032)

- SM8031: Clear the devices outside the latch range.
- SM8032: Clear the range of latch (1) and the range of latch (2).

17.5 Precautions

The precaution to be taken when using a latch function is described below.

- When latch range and device no. of points are changed in the parameter, the latching for devices other than link register (W) and latch label will be the same as the latch settings before the change. Also, if the latch range setting parameter at the time of previous operation is different from that at the time of the current operation after the CPU module is powered OFF and ON or reset, the latch data is recovered only in the overlapping part of the latch ranges.
- When latch range and the number of devices are changed in the parameter, all latch labels are cleared to "0".
- When the CPU parameter, program file, FB file, and global label setting file are changed, all latch labels are cleared to "0". However, when SM9353 (clear/keep of latch labels during PC write) is ON, even if the program file, FB file, and global label setting file are changed, latch labels are not cleared.*1
- Special relays and special registers are not cleared even by performing CPU memory operation or special relay clearing.
- Extended file register (ER) cannot be cleared by special relays (SM8031, SM8032). Use ERINIT instruction, and data batch initialization (clearing values/memory initialization) function of GX Works3 when you clear an extended file register (ER).

(☞ Page 364 Extended file register (ER) function)

- *1 To keep the data of latch label, turn on SM9353 before changing the files. Note that SM9353 can back up the setting in the event of a power interruption, and the setting can be backed up once SM9353 is turned on.
For supported version of SM9353 (clear/keep of latch labels during PC write), refer to (☞ Page 566 Added and Enhanced Functions).

18 MEMORY CARD FUNCTION

The following explains the functions that use SD memory card.

18.1 SD Memory Card Forced Stop

18

SD memory card can be disabled without turning power ON→OFF, even when a function that uses SD memory card is being executed, such as when the data logging function is running.

Methods of SD memory card forced stop

The methods of SD memory card forced stop are as described below.

■Operation by SD memory card disable switch

1. Press the SD memory card disable switch for 1 second or longer.
2. The CARD LED will flash on→turn off.*1
3. Remove the SD card.

*1 If there is a function accessing the SD memory card, the CARD LED will flash off after the access of that function is complete. Therefore, the time from flash on to flash off will be different depending on the function.

■Operation by special relay

1. Turn ON SM606 (SD memory card forcibly disable command).

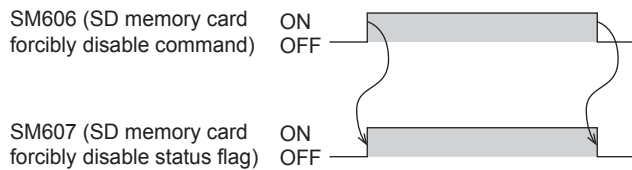

2. Check if CARD LED has turned off or SM607 (SD memory card forcibly disable status flag) has turned ON.
3. Remove the SD card.

Operation of function accessing SD memory card

The following table shows the operation when the main function is executed while SD memory card is being accessed and when SD memory card is accessed after SD memory card is disabled.

Function under execution		When main function is executed while SD memory card is being accessed	When SD memory card is accessed after SD memory card is disabled
Boot operation		After completing execution function, SD memory card turns to disabled status.	—
<ul style="list-style-type: none"> • Access to the label/device comment in the SD memory card • Device/label initialization operation at STOP→RUN 			CPU module error occurs.*1
Access to the SD memory card by engineering tool/SLMP/file transfer function (FTP server, FTP client)		Error handling occurs.	Error handling occurs.
Data logging function		This function works by disabling data writes to the SD memory card while allowing data collection to continue. ( Page 177 SD memory card replacement)	—
Memory dump function		Error handling occurs.	—
Event history function (Save destination: SD memory card)	Logging of the event history	After the event history in the internal memory is stored in the SD memory card, the SD memory card turns to disabled status.	—*2
	Viewing/clearing the event history	Error handling occurs.	Error handling occurs.
Data backup/restoration function		At completion of the backup/restoration processing of a file, the SD memory card is disabled, the backup/restoration function is completed with an error, and then the cause of error is stored in a special register.	The cause of error is stored in a special register.
Extended file register (ER) function		Extended file register (ER) function is completed with an error, and SD memory card turns to disabled status. Also, a operation error 3586H occurs.	A operation error 3586H occurs.

*1 Operation is same as when the SD memory card is not attached.

*2 While being removed, the SD memory card is not accessed. ( Page 197 When files are created)

Releasing the SD memory card forced stop status

After the SD memory card has turned to disable status, release the SD memory card forced stop status by the operation shown below.

1. Load SD card again.*1
2. When a forced stop operation is carried out by SM606, stop SM606.

*1 The CARD LED will blink→light up.

Precautions

The precaution regarding SD memory card forced stop is described below.

- When a forced stop operation is carried out by SD memory card disable switch and forced stop operation by SM606, operation carried out earlier becomes valid, and the operation that is carried out later becomes invalid. For example, after the forced stop by SD memory card disable switch, when SM606 is turned ON→OFF without removing the SD memory card, the disable status of the SD memory card can be released. After the forced stop by SD memory card disable switch, when SD memory card is removed and then SM606 is turned ON, SM606 operation is ignored.

18.2 Boot Operation

At the time of power OFF→ON or reset of the CPU module, a file which is stored on the SD memory card is transferred to the memory of the transfer destination which the CPU module judged automatically.

Boot operation procedure

The selectable files for boot operation are listed below.

1. Carry out the boot file settings.
2. Load SD memory card.
3. Write the boot file settings and boot file to the SD memory card.*1
4. Turn OFF→ON the power or reset the CPU module.

*1 There are two types of writing method to the SD memory card: Online Data Operation (via the CPU module) and Memory Card Operation (direct from the personal computer). For details, refer to the following.

GX Works3 Operating Manual

Specifiable file types

The procedure of boot operation is explained below.

- Parameter files (system parameters, CPU parameters, module parameters, module extension parameters)
- Remote password
- Global labels (global label setting files)
- Program files (programs, restored information)
- FB files (FB, restored information)
- Device comments
- Initial device values

Configuring the boot setting

Carry out the settings required for the boot operation.

Navigation window ⇒ [Parameter] ⇒ [FX5UJCPU] or [FX5UCPU] ⇒ [Memory Card Parameter] ⇒ [Boot Setting]

Operating procedure

"Boot Setting" window

Item	Setting
<input type="checkbox"/> Boot Setting	
<input type="checkbox"/> Clear the CPU built-in memory before boot.	Do Not Clear
<input type="checkbox"/> Boot File Setting	<Detailed Setting>

"Boot File Setting" window

No.	Type	Data Name
1		
2		
3		

"Add Type" window

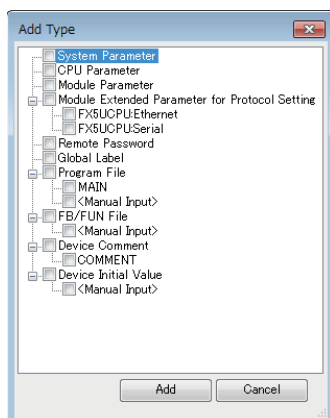

1. Click "Detailed Setting" on the "Boot File Setting".
2. Click the "Type" column. The maximum number of boot files that can be specified is the same as the number of files that can be stored in the storage memory.
3. Select type for the boot file. (Multiple selection possible)

"Boot File Setting" window

No.	Type	Data Name
1	System Parameter	SYSTEM
2	CPU Parameter	CPU
3	Module Parameter	UNIT
4	Module Extended Parameter for Protocol Setting(FX5UCPU/Ethernet)	UEX3FF00
5	Module Extended Parameter for Protocol Setting(FX5UCPU/Serial)	UEX3FF01
6	Remote Password	00000001
7	Global Label	GLBLINF
8	Program File	MAIN
9	Program File	
10	FB/FUN File	
11	Device Comment	COMMENT
12	Device Initial Value	

4. Set the data name (file name).

Displayed items

Item	Description	Setting range	Default
Clear the CPU built-in memory before boot	Sets whether or not to clear the CPU built-in memory upon file transfer from the SD memory card.	<ul style="list-style-type: none"> Do Not Clear Clear 	Do Not Clear
Boot File Setting	Sets the files used for boot operation from the SD memory card.	—	—

Maximum number of boot files that can be specified

It is the same as the number of files that can be stored in transfer destination memory.

Operation when security functions are enabled

This section describes the operation when security functions are enabled.

■When a security key is set

When a security key is set to the boot target program file and the security of the program file does not match with that of the CPU module, a boot error occurs. Also, when no security key is written to the CPU module, a boot error occurs as well.

Security key of boot target program file	Security key of CPU module	Security key match/mismatch	Boot program execution
Set	Written	Match	Execute
	Written	Mismatch	Not execute (boot error)
	Not written	—	Not execute (boot error)

■When a file password is set

If a file password is set on both the source boot file and destination file, the file can be transferred only when the passwords match. Furthermore, the file transfer does not work if a file password is set only on either one.

Transferring boot file		Transferred boot file		Password match/mismatch	Transfer
File	File password setting	File	File password setting		
Existing	Set	Existing	Set	Match	Yes
			Mismatch	No	
		Not set	—	No	
	Not set	Existing	Set	—	Yes
			Not set	—	No
		Not set	—	Yes	

Precautions

The precautions on the boot operation are explained below.

- The parameter file existing on the module of the transfer destination is overwritten, when a parameter file is set to the boot file. Further, if a parameter file is stored in the SD memory card, but not set to the boot file, the operation will follow the parameter file on the module.
- Note that the model of the program written on the SD memory card (program specified in the boot file settings) and the model of the CPU module must be the same.

19 DEVICE/LABEL ACCESS SERVICE PROCESSING SETTING

This is a function to optionally designate the frequency of execution of the service process that is carried out by the END process in the parameter.

Improvement of communication response with peripheral equipment and extension of scan time by the service process can be controlled by service process setting function. With this, building an optimal service process environment on the system is possible.

About device/label access service processing

Device/label access service processing is a response process for the request statement from peripheral equipment that occurs asynchronously with the scan process. (A process of "Interpretation of Request statement→Internal processing based on the request→Creating response statement" for 1 request statement)

The execution timing of the service process is during the END process.

Point 

When every request statement from all connected peripheral equipment is executed in each END process, depending on the number of request statements arriving during 1 scan, the impact on scan time (delay, scattering) may be big. Therefore, by setting the frequency (number of ports) of device/label access service processing to be executed in 1 END processing and regulating the frequency of device/label access service processing according to the system built, ensuring balance between scan time and response time to the peripheral equipment can be achieved.

Compatibility of service process setting

The compatibility of service process setting is described below.

Communication type	Function	Compatibility	
		FX5UJ CPU module	FX5U/FX5UC CPU module
Serial communication	MELSOFT connection	○	○
	MC protocol communication	○	○
	MODBUS communication (slave)	○	○
	N:N Network	—	—
	MODBUS communication (master)	—	—
	Non-protocol communication	—	—
	Inverter communication	—	—
	Predefined protocol support	—	—
	Parallel link	—	—
Ethernet communication	MELSOFT connection	○	○
	SLMP communication	○	○
	Simple CPU communication function (slave)	○	○
	Socket communication	—	—
	Predefined protocol support	—	—
	Simple CPU communication function (master)	—	—
USB communication	MELSOFT connection	○	—

○: Compatible, —: Not compatible

Operation details of service process

The operation details of service process are described below.

The following table shows the methods for service process with their respective features.

Device/label access service processing setting	Scan performance		Service process performance		Device splitting ^{*5}	Features
	Extension ^{*1}	Stability ^{*2}	Response time ^{*3}	Stability ^{*4}		
None	Large	Medium	Fast	High	None	Effective when service process is given precedence.
Set the frequency of service process	Medium	High	Medium	Medium	None	Effective when scan process is given precedence.

*1 Shows the maximum a scan time is extended by the service process.

*2 Shows the extent of fluctuation of scan time or the degree of scattering by the service process.

*3 Shows the time between receiving a service process request from the peripheral equipment to returning a response.

*4 Shows the extent of fluctuation of time until returning the response or the degree of scattering due to the contents of service process request from the peripheral equipment.

*5 Shows if device splitting will occur.

■Device/label access service processing setting "No Setting"

Since all service processes can be executed normally for every scan time, steady communication is possible even on a system that uses multiple peripheral equipment.



Wait for request process will not be executed when there is no request data.

■Device/label access service processing setting "Set Processing Counts"

Because a frequency of service process executed in 1 scan time can be set, the scan time is stabilized even on a system that uses multiple peripheral equipment.

Operation during STOP/PAUSE

Regardless of the service process settings during STOP/PAUSE, execute all requests in scan 1.

However, a request from the identical port will be processed only 1 time in 1 scan.

For example, after serial communication CH1 process, even if serial communication CH1 receives a new command request again when Ethernet connection 1 is in process, the 2nd request is not executed in this scan and will be carried over to the next scan.

Setting method

The device/label access service processing can be configured as follows.

Navigation window ⇒ [Parameter] ⇒ [FX5UJCPU] or [FX5UCPU] ⇒ [CPU Parameter] ⇒ "Service Processing Setting" ⇒ "Device/Label Access Service Processing Setting"

Window

Item	Setting
Device/Label Access Service Processing Setting	
Specifying Method	No Setting
Counts	1 Times

Displayed items

Item	Description	Setting range	Default
Specifying Method	Set the method of device/label access service processing.	<ul style="list-style-type: none"> Set Processing Counts No Setting 	No Setting
Counts	Set the number of executions of device/label access service processing.	1 to 10 [Time] (1 time Unit)	—

Precautions

If "Set Processing Counts" is selected and many service process frequencies are set, when multiple requests are received at the same time, scan time may be prolonged to a large extent, so please exercise caution.

20 DATA LOGGING FUNCTION

This function collects data at a specified interval or a desired timing and stores them as a CSV file or binary file in the SD memory card.

The data logging function can be easily configured by using the CPU Module Logging Configuration Tool.

Collected data can be checked graphically by using GX LogViewer.

The data can be stored in the CSV file format and used also by general-purpose applications such as Excel and Notepad.

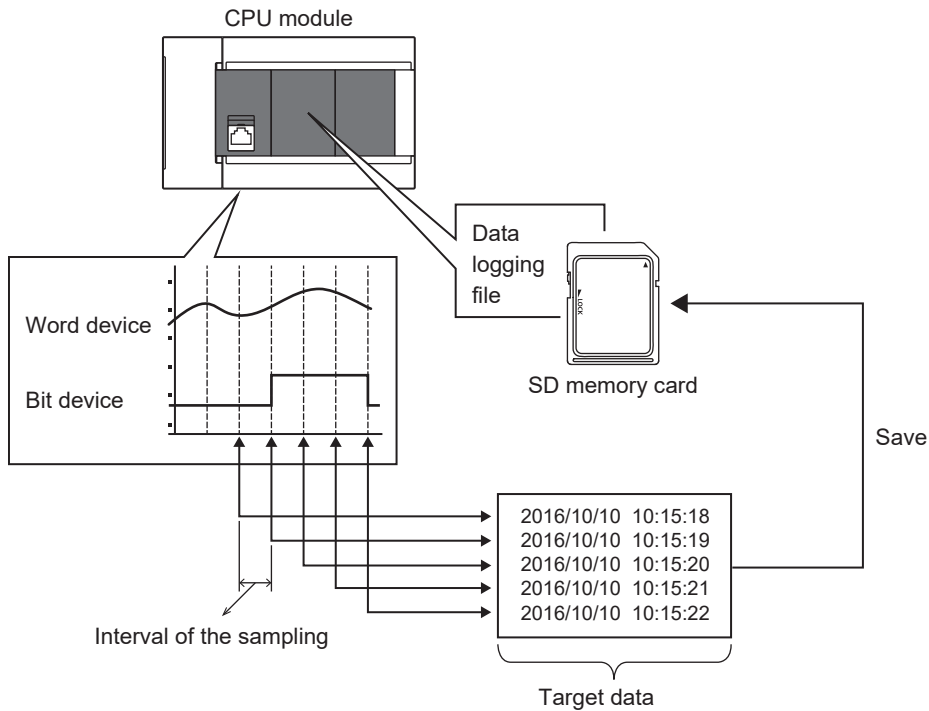

When using the data logging function on the FX5U/FX5UC CPU module, check the version of the module.

([Page 566 Added and Enhanced Functions](#))

For the procedure for using the data logging function, refer to the following page.

([Page 166 Procedure for Using](#))



For the operation of the CPU Module Logging Configuration Tool and the setting method, refer to the following page. ([Page 540 How to Use CPU Module Logging Configuration Tool](#))

20.1 Specifications List

Describes the specifications of the data logging function.

Item			Specifications	Reference
Number of data logging settings			4	—
Data storage location			<ul style="list-style-type: none"> Data memory (only data logging configuration file) SD memory card 	—
Logging type			<ul style="list-style-type: none"> Continuous logging Trigger logging 	Page 146 Logging type
Data collection	Collection interval		<ul style="list-style-type: none"> Each scanning cycle Time specification Condition specification (device specification) 	Page 148 Data collection conditions
	Target data	Number of points for collection	Maximum of 512 (128 per setting)	Page 151 Number of data points
		Data type	<ul style="list-style-type: none"> Bit Word (signed) Double word (signed) Word (unsigned) Double word (unsigned) Single-precision real number String Numeric string Time 	Page 151 Data type
Data processing	Trigger logging	Trigger condition	<ul style="list-style-type: none"> Condition specification (device change specification) When trigger instruction executed 	Page 152 Trigger condition
		Trigger logging range	Number of records specified before and after the trigger establishment	Page 147 Number of records
		Number of trigger establishments (number of events that can be handled as trigger)	one	—
		Number of records	Maximum of 100000	—
File output	File name		Add date + file number	Page 560 Save
	File storage format		<ul style="list-style-type: none"> CSV file^{*1} Binary file 	Page 153 Data logging file
	Data output format	CSV file ^{*1}	<ul style="list-style-type: none"> Decimal format Hexadecimal format Decimal fraction format Exponential format 	Page 153 CSV file format
		Binary file	<ul style="list-style-type: none"> Word (signed) Double word (signed) Word (unsigned) Double word (unsigned) Single-precision real number 	Page 157 Binary file format
Output file handling	Storage file switching	File switching timing	<ul style="list-style-type: none"> Number of records File size Condition specification^{*1} 	Page 162 File switching condition
		Maximum number of storage files	1 to 65535	Page 163 Storage file
Setting Behavior at the Time of Transition to RUN			This function sets data logging operations when entering into RUN mode after the data logging setting is registered.	Page 165 Setting the operation at the time of transition to RUN

*1 Only FX5U/FX5UC CPU module is supported.

20.2 Details of Specifications

Logging type

The following table describes available methods of data collection.

Logging type	Data collection method	Application
Continuous logging	Continuously collects specified data at specified interval or timing.	Allows the user to continuously monitor the content of specified data.
Trigger logging	Collects specified data at specified interval or timing and extracts a specified number of data records before and after the satisfaction of a trigger condition.	Allows the user to monitor the content of specified data before and after the satisfaction of a trigger condition.

Continuous logging

In continuous logging, the CPU module stores specified data in its internal buffer at a specified collection interval or timing and, at the time of a file save operation, it saves the data in a data logging file residing in the storage memory.

In continuous logging, data logging files are constantly created, and the data logging results can be read even if data collection is not finished.

If the “Stop” has been set for “Operation when exceeds the number of files” on the setting screen of the CPU Module Logging Configuration Tool, the collection will be finished when the number of saved files reaches the set “number of files to be saved”.

■To stop continuous logging

The user can completely stop data logging by instructing the CPU Module Logging Configuration Tool or special relay^{*1} to stop data logging and unregister the data logging settings stored in the CPU module. (The special relay (data logging start) turns off.)

*1 This setting is valid only when the data logging setting file is written in the SD memory card. (☞ Page 171 Data Logging Execution by Special Relay)

■To suspend/resume continuous logging

The user can suspend data logging with the data logging settings remaining intact by doing either of the following:

- Instruct the CPU Module Logging Configuration Tool or special relay^{*1} to suspend data logging (the special relay (data logging start) turns off).
- Turn off to on the special relay (Data logging suspend/resume flag).

To resume continuous logging from suspension, do either of the following:

- Instruct the CPU Module Logging Configuration Tool or special relay^{*1} to resume data logging (the special relay (data logging start) turns on).
- Turn on to off the special relay (Data logging suspend/resume flag).

*1 This setting is valid only when the data logging setting file is written in the SD memory card. (☞ Page 171 Data Logging Execution by Special Relay)

Trigger logging

In trigger logging, the CPU module stores specified data in its internal buffer at a specified collection interval or timing; it extracts a specified number of data records before and after the satisfaction of a trigger condition and saves the extracted data in a data logging file residing in the storage memory. Note that data collection is performed not only at the specified collection interval or timing but also when a trigger condition is met. In addition, once a trigger condition is met, any subsequent trigger conditions are ignored.

When the data for the number of records specified by the CPU Module Logging Configuration Tool is collected and written to the storage memory, the collection will be finished.

■To stop trigger logging

The user can completely stop data logging by instructing the CPU Module Logging Configuration Tool or special relay^{*1} to stop data logging and unregister the data logging settings stored in the CPU module. (The special relay (data logging start) turns off.)

*1 This setting is valid only when the data logging setting file is written in the SD memory card. (☞ Page 171 Data Logging Execution by Special Relay)

■To suspend/resume trigger logging

The user can suspend data logging with the data logging settings remaining intact by doing either of the following:

- Instruct the CPU Module Logging Configuration Tool or special relay^{*1} to suspend data logging (the special relay (data logging start) turnsoff).
- Turn off to on the special relay (Data logging suspend/resume flag).

To resume trigger logging from suspension, do either of the following:

- Instruct the CPU Module Logging Configuration Tool or special relay^{*1} to resume data logging (the special relay (data logging start) turns on).
- Turn on to off the special relay (Data logging suspend/resume flag).

*1 This setting is valid only when the data logging setting file is written in the SD memory card. (☞ Page 171 Data Logging Execution by Special Relay)

Precautions

If data logging is stopped or data collection is suspended before completion of trigger logging and then data logging is resumed, data collection will be started not from the last logging, but from the initial state before the trigger logging.

■Number of records

Specify the number of records to be collected before and after the satisfaction of a trigger condition. (☞ Page 558 Number of records)

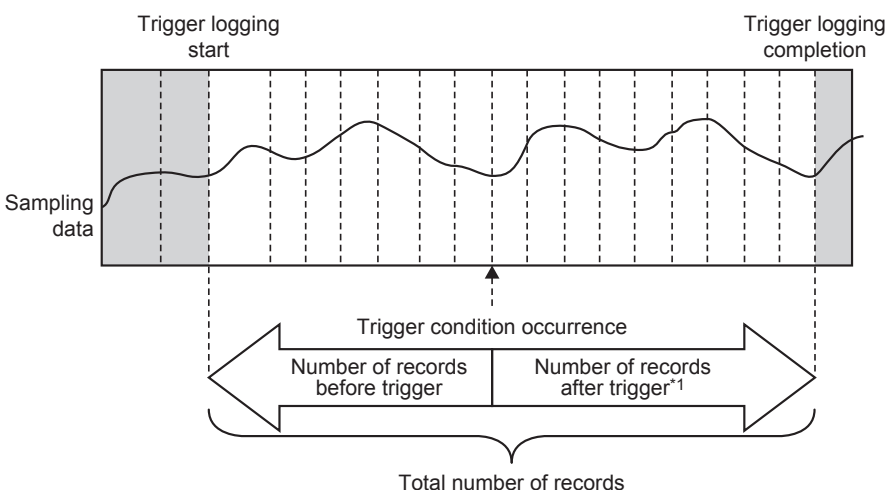

*1 This number includes the record exactly at the time when the trigger condition is met.

Point

After starting data logging, if the trigger condition is met before data collection of the specified number of records (before trigger) is completed, the number of sampled records will be less than that specified.

Data collection conditions

This section describes the timing when data is collected and the conditions under which data is collected.

Data collection conditions	Description
Each scanning cycle	Collects data during the END processing of each scan.
Time specification	Collects data during the END processing after specified time interval.
Condition specification	Collects data when the monitored data meets the specified condition during the END processing.

Each scanning cycle

Collects data during the END processing of each scan.

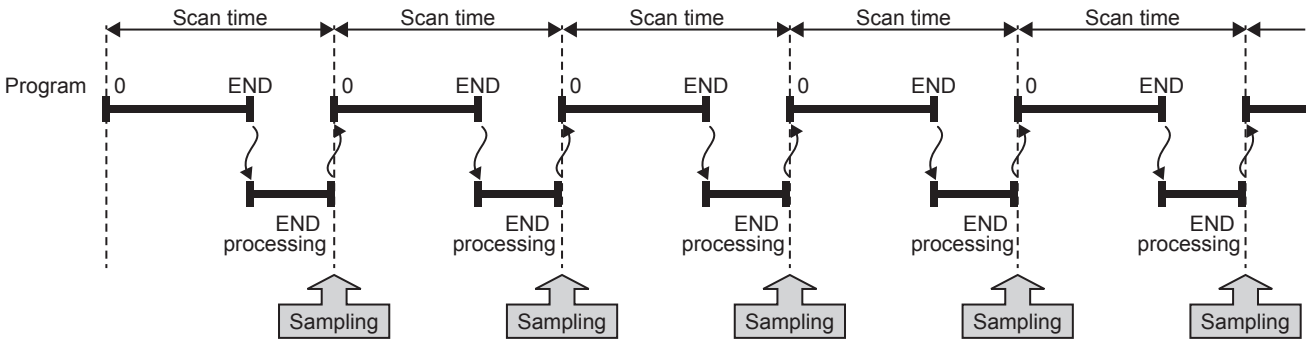

Precautions

When specifying each scanning cycle, make only one data logging setting.

Time specification

Allows the user to specify the collection time interval.

The CPU module starts collecting data at the time of the following END process after the specified time has elapsed. Ensure that the "Scan time" is less than "Time specification." If the scan time is longer than the specified time and the collection interval or the collection timing occurs more than once during the same scan, data is collected only once during the END processing. Data collection is performed on a scan by scan basis, which is the same operation as when "Each scanning cycle" is used.

Ex.

When the time interval is set to 10 milliseconds

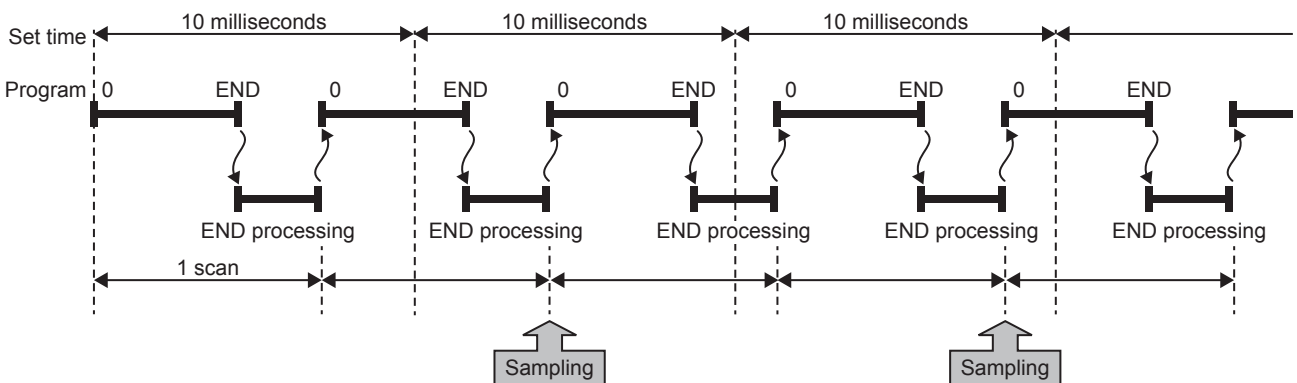

Condition specification

This option allows the user to set the data collection timing by specifying the device data conditions. Collects data when the monitored data meets the specified condition during the END processing.

■ To collect data continuously while the conditions are met

The following conditional formula causes the data logging function to collect data continuously while the conditions are met:

- =: When the current value of the monitored data is equal to the comparison value
- ≠: When the current value of the monitored data is not equal to the comparison value
- ≥: When the current value of the monitored data is equal to or larger than the comparison value
- >: When the current value of the monitored data is larger than the comparison value
- ≤: When the current value of the monitored data is equal to or smaller than the comparison value
- <: When the current value of the monitored data is smaller than the comparison value

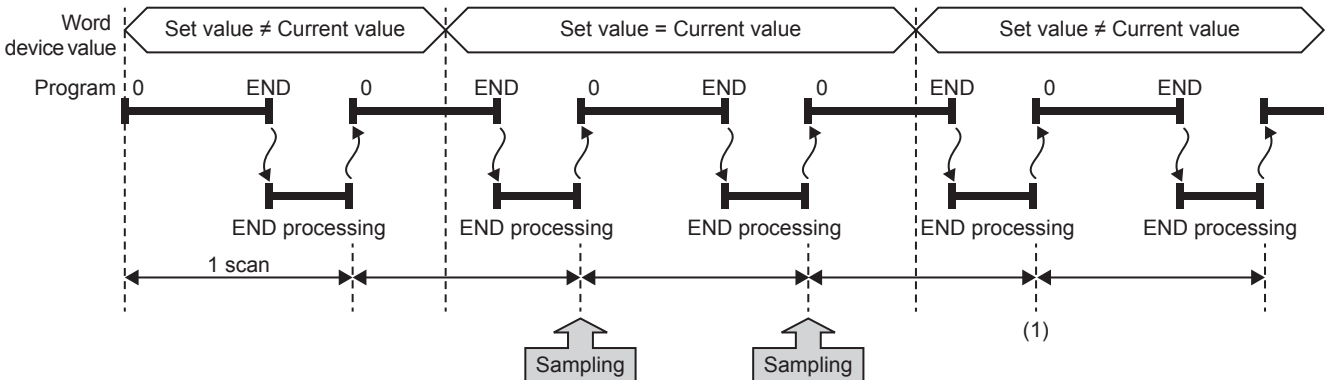

(1) During the END processing, the data logging function does not collect data because the conditions are not met.

■ To collect data only when the state changes

The following conditional formula causes the data logging function to collect data only during the END processing for the scans where the conditional formula is met. It does not collect data for any single scan where the conditional formula is not met during the END processing (even if the conditional formula is met before the END processing is initiated).

- ↑: When the specified data turns from off to on
- ↓: When the specified data turns from on to off
- At change: When the current value of the specified data changes

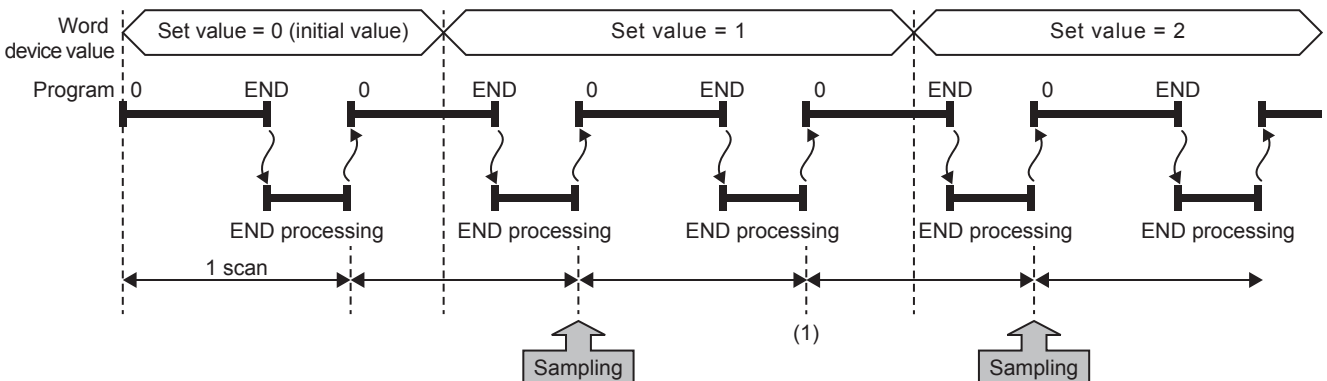

(1) The data logging function does not collect data because there has been no change in state since the last scan.

■Specifying the monitored data

For monitored data, the following devices can be specified. The data types that can be selected include bit/word (unsigned), word (signed), double word (unsigned), and double word (signed).

Type	Device ^{*1}
Bit device ^{*2}	X, Y, M, SM, L, B, F, SB, T (contact) ^{*4} , ST (contact) ^{*4} , C (contact) ^{*4} , LC (contact) ^{*4} , BL□\S□ ^{*5}
Word device ^{*3}	T (current value) ^{*6} , ST (current value) ^{*6} , C (current value) ^{*6} , D, SD, W, SW, R, U□\G□
Double-word device	LC (current value) ^{*6}

*1 Index modification, and indirect specification cannot be specified.

*2 For bit devices, bit specification of word cannot be specified.

*3 For word devices, nibble specification of bit devices cannot be specified.

*4 To specify these devices with the CPU Module Logging Configuration Tool, use T (contact): TS, ST (contact): STS, C (contact): CS, LC (contact): LCS.

*5 Only FX5U/FX5UC CPU module is supported.

*6 To specify these devices with the CPU Module Logging Configuration Tool, use T (current value): T or TN, ST (current value): ST or STN, C (current value): C or CN, and LC (current value): LC or LCN.

Target data

This section describes the data to be collected by data logging.

Number of data points

The data logging function can collect up to 512 data records. (4 settings × 128 records)^{*1}

*1 Duplicate data records are counted as unique records.

Data to be collected

The data for the following devices can be specified to be collected.

Type	Device ^{*1}
Bit device ^{*2}	X, Y, M, SM, L, B, F, SB, T (contact) ^{*4} , T (coil) ^{*4} , ST (contact) ^{*4} , ST (coil) ^{*4} , C (contact) ^{*4} , C (coil) ^{*4} , LC (contact) ^{*4} , LC (coil) ^{*4} , BL□\S□ ^{*5}
Word device ^{*3}	T (current value) ^{*6} , ST (current value) ^{*6} , C (current value) ^{*6} , D, SD, W, SW, R, U□\G□
Double-word device	LC (current value) ^{*6}

*1 Index modification, and indirect specification cannot be specified.

*2 For bit devices, bit specification of word cannot be specified.

*3 For word devices, nibble specification of bit devices cannot be specified.

*4 To specify these devices with the CPU Module Logging Configuration Tool, use T (contact): TS, T (coil): TC, ST (contact): STS, ST (coil): STC, C (contact): CS, C (coil): CC, LC (contact): LCS, and LC (coil): LCC.

*5 Only FX5U/FX5UC CPU module is supported.

*6 To specify these devices with the CPU Module Logging Configuration Tool, use T (current value): T or TN, ST (current value): ST or STN, C (current value): C or CN, and LC (current value): LC or LCN.

Data type

The following table shows the number of data records for each data type.

Data type	Data number of points
Bit	1
Word (signed)	1
Double word (signed)	2
Word (unsigned)	1
Double word (unsigned)	2
Single-precision real number	2
Time	2
String ^{*1*2}	Specified size/2 ^{*3}
Numeric string ^{*2}	Specified size/2 ^{*3}

*1 Outputs the entered character code.

*2 Collected as binary data.

*3 The specified size can be 1 to 256. If the specified size is an odd number, the number of data records is rounded to the next higher integer. Example: The number of data records is 3 if the specified size is 5.

Trigger condition

The following table lists the conditions to be used as a trigger.

Trigger condition	Description
Condition specification	A trigger occurs when the monitored data meets the specified condition.
When trigger instruction executed	A trigger occurs when the LOGTRG instruction is executed.

Precautions

- When registering the data logging settings, ensure that the trigger conditions are not met. If the trigger conditions are met, the data logging settings cannot be registered.
- After the trigger condition is established in the trigger logging operation, if the trigger condition is met again, the CPU module does not recognize a new trigger condition.

Condition specification

Configure the trigger condition based on the device data value. A trigger occurs when the monitored data meets the specified condition.

- ↑: When the specified data turns from off to on
- ↓: When the specified data turns from on to off
- =: When the monitored data is equal to the comparison value, regardless of whether or not its current value is equal.
- ≠: When the monitored data is not equal to the comparison value, regardless of whether or not its current value is equal.
- ≥: When the monitored data is equal to or larger than the comparison value, regardless of whether or not its current value is equal.
- >: When the monitored data is larger than the comparison value, regardless of whether or not its current value is equal.
- ≤: When the monitored data is equal to or smaller than the comparison value, regardless of whether or not its current value is equal.
- <: When the monitored data is smaller than the comparison value, regardless of whether or not its current value is equal.
- At change: When the current value of the specified data changes

■ Specifying the monitored data

For the device change specification, monitored data can be configured to be collected from the devices listed in the following table. The data types that can be selected include bit/word (unsigned), word (signed), double word (unsigned), and double word (signed). If double word (unsigned) or double word (signed) is specified, a trigger occurs only when data equal to one double word is written. No trigger occurs when only the upper or lower word of a double word is written.

Type	Device ^{*1}
Bit device ^{*2}	X, Y, M, SM, L, B, F, SB, T (contact) ^{*4} , ST (contact) ^{*4} , C (contact) ^{*4} , LC (contact) ^{*4}
Word device ^{*3}	T (Current value) ^{*5} , ST (Current value) ^{*5} , C (Current value) ^{*5} , D, SD, W, SW, R, U□\G□
Double-word device	LC (Current value) ^{*5}

*1 Index modification, and indirect specification cannot be specified.

*2 For bit devices, bit specification of word cannot be specified.

*3 For word devices, nibble specification of bit devices cannot be specified.

*4 To specify these devices with the CPU Module Logging Configuration Tool, use T (contact): TS, ST (contact): STS, C (contact): CS, LC (contact): LCS.

*5 To specify these devices with the CPU Module Logging Configuration Tool, use T (current value): T or TN, ST (current value): ST or STN, C (current value): C or CN, and LC (current value): LC or LCN.

When trigger instruction executed

A trigger occurs when the LOGTRG instruction is executed. (MELSEC iQ-F FX5 Programming Manual (Instructions, Standard Functions/Function Blocks))

Data logging file

This section describes data logging files.

The following storage formats are available for data logging files.

File format	Application
CSV file format*1	This is a file format which can be open in generic-purpose application programs such as Excel and Notepad. GX LogViewer is also available for displaying data.
Binary file format	Comparing the CSV file format, the size of files is small and therefore quicker access to files is provided. GX LogViewer is also available for displaying data.

*1 Only FX5U/FX5UC CPU module is supported. For supported version, refer to  Page 566 Added and Enhanced Functions.

Data output specifications

The output specifications for each file format are shown below.

■CSV file format

The specifications for the CSV file format and the details of the output data are shown below.

- Format specifications

Item	Description
Delimiter	Commas (,)
Return code	CRLF (0x0D, 0x0A)
Character code	ASCII code or Shift-JIS code
Field data	Not enclosed by double quotation marks (" ") Double quotation marks (" ") and commas (,) cannot be used in each data.

- File format example

Output items can be specified ( Page 559 Output)

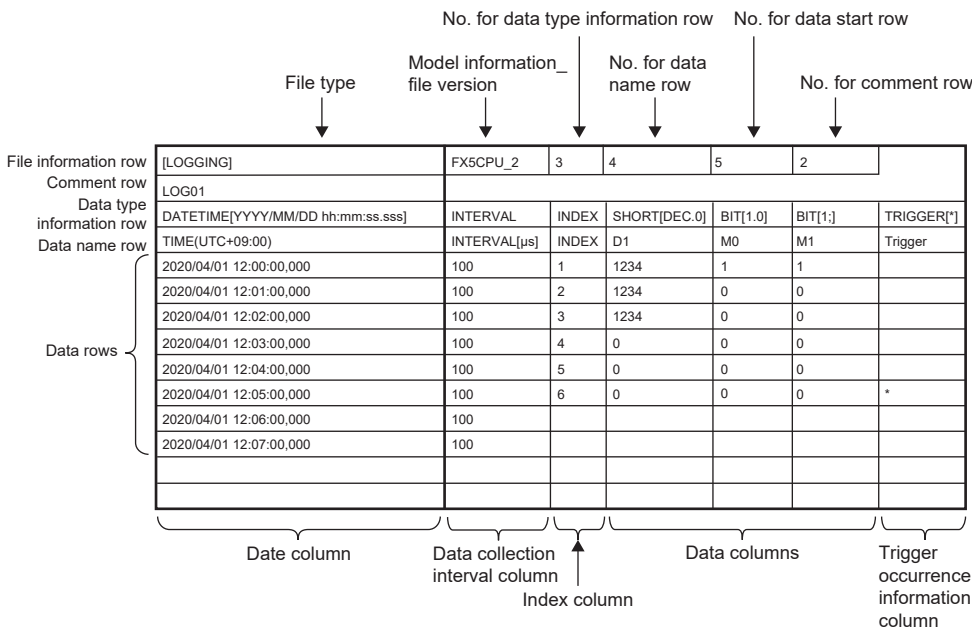

The diagram illustrates the structure of a CSV file output. It shows a grid of rows and columns with various annotations:

- File type:** [LOGGING]
- Model information_ file version:** FX5CPU_2
- No. for data type information row:** 3
- No. for data name row:** 4
- No. for data start row:** 5
- No. for comment row:** 2

The rows are categorized as follows:

- File information row:** [LOGGING]
- Comment row:** LOG01
- Data type information row:** DATETIME[YYYY/MM/DD hh:mm:ss.sss]
- Data name row:** TIME(UTC+09:00)
- Data rows:** Multiple rows containing data such as 2020/04/01 12:00:00,000, 100, 1, 1234, 1, 1, and Trigger.

The columns are categorized as follows:

- Date column:** TIME(UTC+09:00)
- Data collection interval column:** INTERVAL[μs]
- Index column:** INDEX
- Data columns:** SHORT[DEC.0], BIT[1.0], BIT[1:], TRIGGER[*]
- Trigger occurrence information column:** Trigger

- Output content for each data

<File information row>

File-related information is displayed.

Item	Description	Size
File type	[LOGGING] is output.	9 bytes
Model information_file version	"FX5CPU_2" is displayed in the file version which describes the model information.	8 bytes
No. for data type information row	Numerical value indicating the position of the data type information row from the top of the file is placed.	1 byte
No. for data name row	Numerical value indicating the position of the data name row from the top of the file is placed.	1 byte
No. for data start row	Numerical value indicating the starting position of the data row from the top of the file is placed.	1 byte
No. for comment row	Numerical value indicating the position of the comment row from the top of the file is placed. When the comment row is not output, this field is blank.	0 to 1 byte

Ex.

The total size of the file information row can be obtained by the following equation: (when comment is output)

9 (file type) + 8 (model information_file version) + 1 (data type information row number) + 1 (data name row number) + 1 (data start row number) + 1 (comment row number) + 5 (the number of commas) + 2 (CR + LF)

= 28 bytes

<Comment row>

Comments are displayed.

Item	Description	Size
Comment	Comment specified in CPU Module Logging Configuration Tool is output (Up to 256 double-byte characters can be used.*1 When no comment is set, a blank row is output).	0 to 512 bytes

*1 Double quotation marks (" "), commas (,), and semicolons (;) cannot be used.

Ex.

The total size of the comment row can be obtained by the following equation:

Character size of the specified comment (depending on the specified character string. (A single-byte character is calculated as one byte and a double-byte character is calculated as two bytes.) + 2 (CR + LF)

<Data type information row>

The data type for each column is displayed. This information is output in the following format: (Data type)[(Additional information)].

Item	"Data type" output content	Size	"Additional information" output content	Size
Date column	DATETIME	8 bytes	Format is output. [YYYY/MM/DD hh:mm:ss.sss]	4 to 29 bytes
Data collection interval column	INTERVAL	8 bytes	No additional information	0 byte
Index column	INDEX	5 bytes	No additional information	0 byte
Data column	Bit type: BIT	3 bytes	Bit type: [1;0]	5 bytes
	16-bit integer (signed): SHORT	5 bytes	For decimal format: [DEC.0]	7 bytes
	16-bit integer (unsigned): USHORT	6 bytes	For hexadecimal format: [HEX]	5 bytes
	32-bit integer (signed): LONG	4 bytes	When the decimal fraction format is specified: [DEC. (number of digits of decimal part)]	7 to 8 bytes
	32-bit integer (unsigned): ULONG	5 bytes		
	Single-precision floating point (32-bit): FLOAT	5 bytes	When the exponential format is specified: [EXP. (number of digits of decimal part)]	7 to 8 bytes
	Character string type: STRING	6 bytes	Character string type, numeric string type: the specified data length value (unit: bytes) is output.	3 to 5 bytes
	Numeric string type: RAW	3 bytes		
Time: TIME	4 bytes	No additional information	0 byte	
Trigger occurrence information column	TRIGGER	7 bytes	[(string occurred)] is output (semicolons (;), double quotation marks (" "), and commas (,) cannot be used).	3 to 514 bytes

Ex.

The size of the data type information row is determined by the following equation when data logging of 128 points of data (signed 16-bit integer, decimal format) is performed (The following sections in the "Output" window are set to be output: "Date" (the output format is YYYY/MM/DD hh:mm:ss.sss), "Data sampling interval", and "Index").

$$(8 + 25) \text{ (date column)} + 8 \text{ (data collection interval column)} + 5 \text{ (index column)} + (5 + 7) \times 128 \text{ (data column)} + 135 \text{ (the number of commas)} + 2 \text{ (CR + LF)}$$

$$= 1716 \text{ bytes}$$

<Data name row>

The data name for each column is displayed.

Item	Description	Size
Date column	TIME (time zone) is output.	4 bytes
Data collection interval column	INTERVAL[us] is output.	12 bytes
Index column	INDEX is output.	5 bytes
Data column	The specified device name is output.	1 to 32 bytes
Trigger occurrence information column	Trigger is output.	7 bytes

Ex.

The size of the data name row is determined by the following equation when data logging of 128 data points from D100 to D227 is performed (The following sections in the "Output" window are set to be output: "Date", "Data sampling interval", and "Index").

$$4 \text{ (date column)} + 12 \text{ (data collection interval column)} + 10 \text{ (index column)} + (4 \times 128) \text{ (data column)} + 132 \text{ (the number of commas)} + 2 \text{ (CR + LF)}$$

$$= 667 \text{ bytes}$$

<Data row>

The collected data value is displayed. A single row means the data collection interval. The data collected by the trigger at a time is displayed in the single row.

Item	Description	Size
Date column	Information is output according to the date information.	1 to 32 bytes
Data collection interval column	The time interval from the previous collection time to the current collection time is output. If the maximum display range is exceeded, the count returns to 1 and starts again to output a new time interval (unit: μ s, display range: 1 to 100000000000).	1 to 12 bytes
Index column	A value which increments in ascending order from 1 is output. When it exceeds the upper limit, it returns to 1 and increments again (range: 1 to 4294967295).	1 to 10 bytes
Data column	The collected data value is output in a format and size in accordance with each data type.	—
	When bits are specified: bit On = 1 and bit Off = 0 are output.	1 byte
	When signed word type is specified: data value is output according to the specified output type.	<ul style="list-style-type: none"> • Decimal format: 1 to 6 bytes • Decimal fraction format: 1 to 21 bytes^{*1} • Exponential format: 5 to 21 bytes
	When unsigned word type is specified: data value is output according to the specified output type.	<ul style="list-style-type: none"> • Decimal format: 1 to 6 bytes • Hexadecimal format: 1 to 4 bytes • Decimal fraction format: 1 to 21 bytes^{*1} • Exponential format: 5 to 21 bytes
	When signed double word type is specified: data value is output according to the specified output type.	<ul style="list-style-type: none"> • Decimal format: 1 to 11 bytes • Decimal fraction format: 1 to 26 bytes^{*1} • Exponential format: 5 to 22 bytes
	When unsigned double word type is specified: data value is output according to the specified output type.	<ul style="list-style-type: none"> • Decimal format: 1 to 11 bytes • Hexadecimal format: 1 to 8 bytes • Decimal fraction format: 1 to 26 bytes^{*1} • Exponential format: 5 to 22 bytes
	When single-precision real number is specified: data value is output according to the specified output type. ^{*2}	<ul style="list-style-type: none"> • Decimal format: 1 to 11 bytes • Decimal fraction format: 1 to 26 bytes • Exponential format: 5 to 22 bytes
	When character string is specified: the specified character string is output. ^{*3}	1 to 256 bytes
Trigger occurrence information column	When numeric string is specified: the character string which is represented by the hexadecimal in increments of a byte is output without clearance. [Ex.] When the start device is D0 and the numeric string is four bytes, it will be displayed as: D0:0x8A6B, D1:0x41C2 → "6B8AC241"	2 to 512 bytes
	When time is specified: T#-24d20h31m23s648ms to T#24d20h31m23s647ms is displayed.	13 to 20 bytes
Trigger occurrence information column	The specified character string is output when the trigger occurs. In other cases, no character string is output.	0 to 512 bytes

*1 When the numerical value to be output becomes out of the range of -2147483648.0 to 4294967295.0, it will be displayed in an equivalent format to "exponential format and the number of decimal part digits is nine".

*2 When the data value is not the output format specified in the data type, "NaN" will be output in the data row.

*3 When "0" which means the end of a character string is in the data, the subsequent data will not be output. Characters which is out of the range of ASCII or SJIS such as double quotation mark ("), comma (,), semicolon (;) will be replaced with period (.).

Ex.

The size of the data type information row is determined by the following equation when data logging of 128 points of data from D100 to D227 (unsigned word type, decimal format) is performed (The following sections in the "Output" window are set to be output: "Date" (the output format is YYYY/MM/DD hh:mm:ss.sss), "Data sampling interval", and "Index").

$$23 \text{ (date column)} + 12 \text{ (data collection interval column)} + 10 \text{ (index column)} + (6 \times 128) \text{ (data column)} + 132 \text{ (the number of commas)} + 2 \text{ (CR + LF)}$$

$$= 947 \text{ bytes}$$

Binary file format

The following figure shows the configuration of the binary format and details of each data.

- Configuration figure of binary format

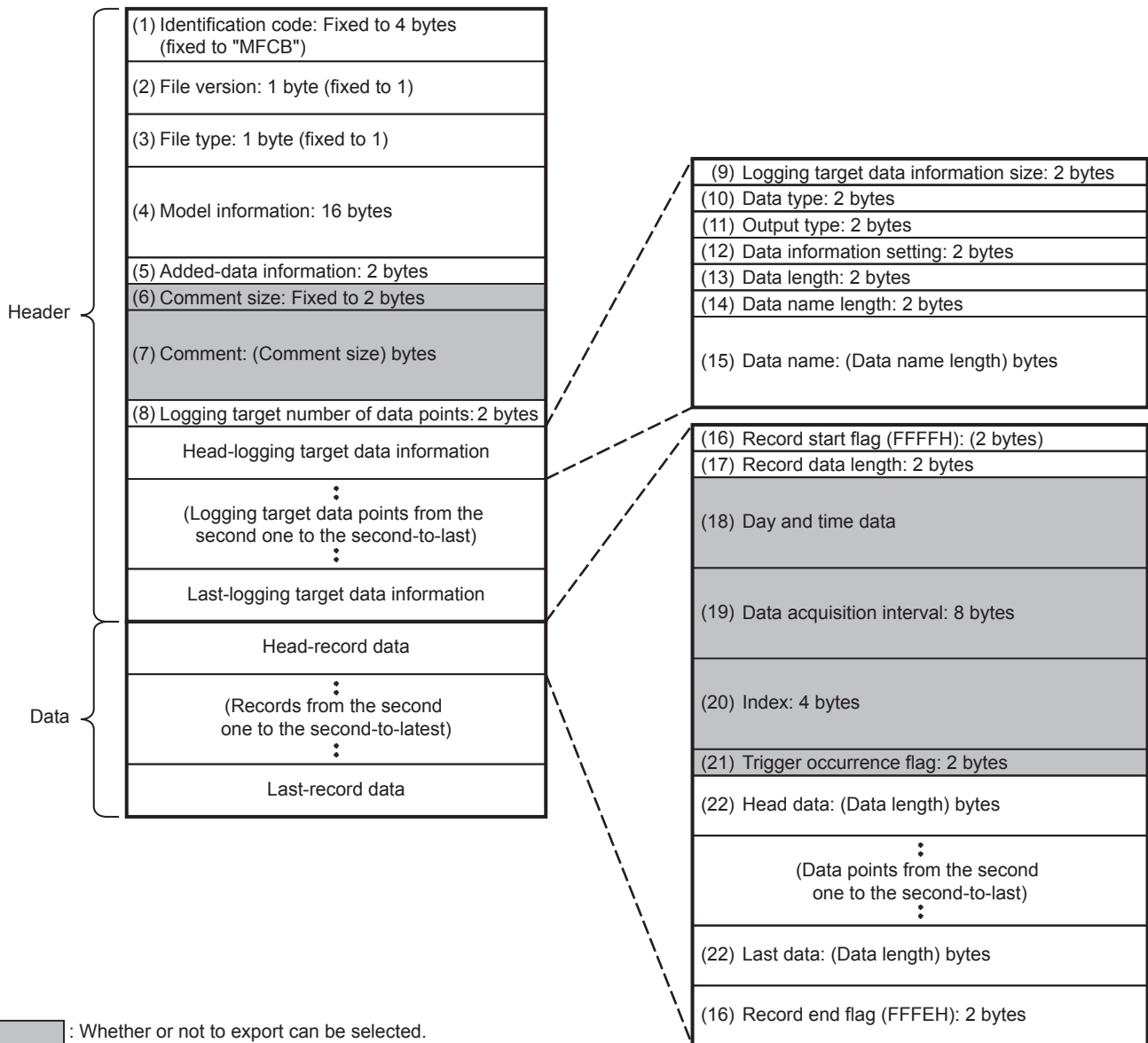

• Details of each data

No.	Item	Description	Size (byte)												
(1)	Identification code	MFCB is always output to identify the file.	4												
(2)	File version	File version 1 is displayed.	1												
(3)	File type	The file type is output. (fixed to 1: Continuous/trigger logging)	1												
(4)	Model information	The module model name that outputted binary file is output. "FX5UJ" or "FX5U" output is generated in ASCII Code while the remaining area is filled with "0H".	16												
(5)	Added-data information	<p>The output selection setting for the data that can be output is output.</p> <p>F E D C B A 9 8 7 6 5 4 3 2 1 0</p> <p>(1) 1: Output date and time data, 0: Do not output date and time data (2) 1: Output a data sampling interval, 0: Do not output a data sampling interval (3) 1: Output a trigger flag, 0: Do not output a trigger flag (4) 1: Output index, 0: Do not output index (5) 1: Output comments, 0: Do not output comments</p>	2												
(6)	Comment size	The comment length of (7) Comment is output.	2												
(7)	Comment	The comment specified in the setting is output in Unicode.	2 to 512												
(8)	Logging target number of logging target data	The number of data points of the data information ((10) to (15)) for data logging is output.	2												
(9)	Logging target data information size	The total size of the data information ((10) to (15)) for data logging is output.	2												
(10)	Data type	<p>The numeric value shown below is output depending on the data type.</p> <p>0000H: Bit 0001H: Word (signed) 0002H: Double word (signed) 0003H: Word (unsigned) 0004H: Double word (unsigned) 0005H: Single-precision real number 0007H: String 0008H: Numeric string 0009H: Time</p>	2												
(11)	Output type	<p>The numeric value shown below is output depending on the set output format.</p> <p>0001H: Word (signed) 0002H: Double word (signed) 0003H: Word (unsigned) 0004H: Double word (unsigned) 0005H: Single-precision real number FFFFH: Bit, String, Numeric string, Time</p>	2												
(12)	Data information setting	The data-related information is output.	2												
(13)	Data length	The data length of data is output. When the data type is the bit type, it will be output as two bytes.	2												
(14)	Data name length	The length of the data name specified in the setting is output.	2												
(15)	Data name	The data name specified in the setting is output in Unicode.	2 to 512												
(16)	Record start Flag, Record end Flag	The flags for identifying the start and end of the record are output. The FFFFH is output for record start while the FFFE H is output for record end as the fixed flag.	2												
(17)	Record data length	The total size of (20) Day and time data to (24) Last data is output.	2												
(18)	Day and time data	<p>The Day and time data is output.</p> <p>b15 to b8 b7 to b0</p> <table border="1"> <tr> <td>Year</td> <td>Month</td> <td>Year: Last 2 digits of the year, Month: 1 to 12</td> </tr> <tr> <td>Day</td> <td>Time</td> <td>Day: 1 to 31, Time: 0 to 23</td> </tr> <tr> <td>Minute</td> <td>Second</td> <td>Minute: 0 to 59, Second: 0 to 59</td> </tr> <tr> <td colspan="2">Millisecond</td> <td>Millisecond: 0 to 999</td> </tr> </table>	Year	Month	Year: Last 2 digits of the year, Month: 1 to 12	Day	Time	Day: 1 to 31, Time: 0 to 23	Minute	Second	Minute: 0 to 59, Second: 0 to 59	Millisecond		Millisecond: 0 to 999	8
Year	Month	Year: Last 2 digits of the year, Month: 1 to 12													
Day	Time	Day: 1 to 31, Time: 0 to 23													
Minute	Second	Minute: 0 to 59, Second: 0 to 59													
Millisecond		Millisecond: 0 to 999													
(19)	Data acquisition interval	The time interval from the previous collection time to the current collection time is output. (Unit: μ s, Display range: 1 to 10000000000 (When it exceeds the maximum value, it returns to "1" and incrementing runs again.)) After logging collection is started, 0 is stored at the first collection.	8												
(20)	Index	The index number ranging from 1 to 4294967295 of data, which was collected by the data logging function, is output. When it exceeds the maximum value, it returns to "1" and incrementing runs again. If missing occurs in processing data, index will be reassigned from 1 again.	4												

No.	Item	Description	Size (byte)
(21)	Trigger occurrence flag	<p>The trigger occurrence information is output.</p> <p>b15 to b1 b0</p>  <p>(1) 1: Trigger occurred, 0: Trigger not occurred</p>	2
(22)	Data	<p>Data collected by the data logging function is output corresponding to (13) Data length and (10) Data type.</p> <ul style="list-style-type: none"> • When bits are specified: bit On = 1 and bit Off = 0 are output. • When word type (signed/unsigned) or double-word type (signed/unsigned) is specified: the data values are output in the specified unit. • When single-precision real number is specified: data value is output in the specified unit. (Page 159 Numerical value range for each output type) • When character string type is specified: the character string with the specified size is output. If the character string terminator "0" exists in the middle of data, NULL is generated on from said point onward until the terminator of the specified size. • When numeric string type is specified: the data value with the specified size is output. • When time is specified: data value is output in the ms unit. 	<ul style="list-style-type: none"> • Bit: 2 • Word (signed/unsigned): 2 • Double word (signed/unsigned): 4 • Single-realnumber: 4 • String/numeric string: 1 to 256 • Time: 4

Numerical value range for each output type

Describes the numerical value ranges that can be output for each output type.

Integer type

The following table lists the numerical value ranges that can be expressed for each integer type.

Output format	Lower limit	Upper limit
Word (unsigned)	0	65535
Word (signed)	-32768	32767
Double word (unsigned)	0	4294967295
Double word (signed)	-2147483648	2147483647

Real number type

The following table lists the numerical value ranges that can be expressed for each real number type.

Output format	Negative value		Positive value	
	Lower limit	Upper limit	Lower limit	Upper limit
Single-precision real number	-3.4028235E+38	-1.401298E-45	1.401298E-45	3.4028235E+38

Saving and file switching

The collected data is temporarily stored in the specified internal buffer. (☞ Page 164 Internal buffer) The data stored in the internal buffer is stored into the SD memory card at the time of a file save operation.

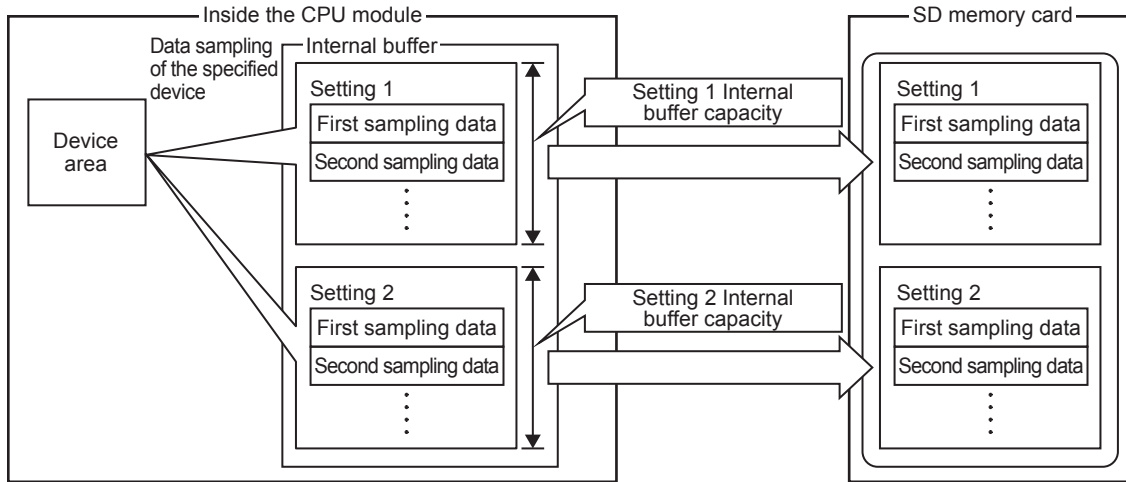

Destinations to save data logging files

The following figure shows the folder configuration of the SD memory card attaching to a CPU module.

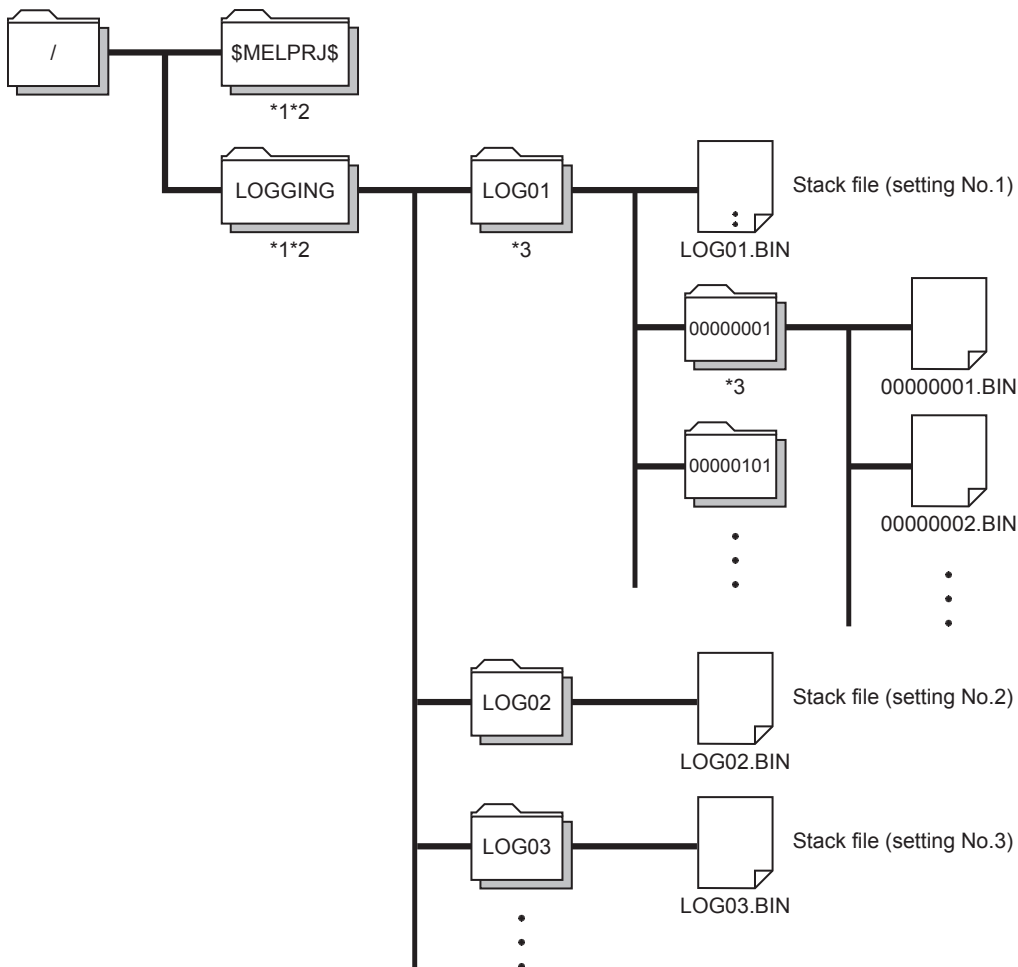

- *1 Folder names cannot be modified.
- *2 Do not create folders/files under the \$MELPRJ\$ and LOGGING folders using a personal computer or other device.
- *3 To remove unnecessary folders, use the following methods:
 - Use a personal computer.
 - Logging file operation (☞ Page 553 Logging file operation)

Switching to a storage file

The data collected by data logging is temporarily stored in a stack file that resides in the SD memory card. The stack file can be switched to a storage file to free the space in the SD memory card.

File switching works as follows:

1. The CPU module writes collected data into a stack file (such as LOG01.BIN).
2. It changes the file name when the storage file switching condition is met.*1
3. It creates a new stack file.
4. It continues to write collected data into the newly created stack file.

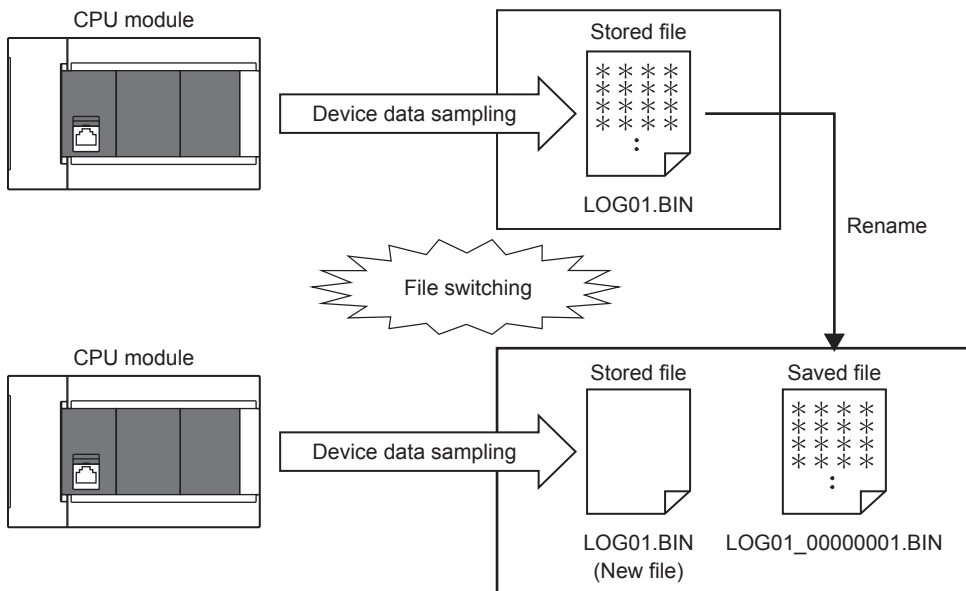

*1 The file name format can be customized. (Page 560 Save)
The file number of the most recent storage file is stored in the special register (Latest storage file number).

File switching condition

The following table lists the setting items that can be used to specify the file switching condition.

Setting item	Description
Number of records	Specify the number of records within the range of 1 to 65500.
File size ^{*1}	Specify the number of kilobytes within the range of 10 to 16384K bytes.
Condition specification ^{*1}	Specify conditions of the device data to be executed for file switching.

^{*1} File switching occurs before the file grows beyond the specified size.

However, file switching occurs regardless of the setting when:

- The number of records has reached 65500;
- The file size has reached 16M bytes;
- The CPU module is stopped or suspended/resumed.
- Data logging is started and there is an existing stack file.

■Condition specification

Configure the trigger condition based on the device data value. A trigger occurs when the monitored data meets the specified condition.

- ↑: When the specified data turns from off to on
- ↓: When the specified data turns from on to off
- =: When the monitored data is equal to the comparison value, regardless of whether or not its current value is equal.
- ≠: When the monitored data is not equal to the comparison value, regardless of whether or not its current value is equal.
- ≥: When the monitored data is equal to or larger than the comparison value, regardless of whether or not its current value is equal.
- >: When the monitored data is larger than the comparison value, regardless of whether or not its current value is equal.
- ≤: When the monitored data is equal to or smaller than the comparison value, regardless of whether or not its current value is equal.
- <: When the monitored data is smaller than the comparison value, regardless of whether or not its current value is equal.
- At change: When the current value of the specified data changes

■Specifying the monitored data

For the device change specification, monitored data can be specified from the devices listed in the following table. The data types that can be selected include bit/word (unsigned), word (signed), double word (unsigned), and double word (signed). If double word (unsigned) or double word (signed) is specified, a trigger occurs only when data equal to one double word is written. No trigger occurs when only the upper or lower word of a double word is written.

Type	Device ^{*1}
Bit device ^{*2}	X, Y, M, SM, L, B, F, SB, T (contact) ^{*4} , ST (contact) ^{*4} , C (contact) ^{*4} , LC (contact) ^{*4}
Word device ^{*3}	T (Current value) ^{*5} , ST (Current value) ^{*5} , C (Current value) ^{*5} , D, SD, W, SW, R, U□\G□
Double-word device	LC (Current value) ^{*5}

^{*1} Index modification, and indirect specification cannot be specified.

^{*2} For bit devices, bit specification of word cannot be specified.

^{*3} For word devices, nibble specification of bit devices cannot be specified.

^{*4} To specify these devices with the CPU Module Logging Configuration Tool, use T (contact): TS, ST (contact): STS, C (contact): CS, LC (contact): LCS.

^{*5} To specify these devices with the CPU Module Logging Configuration Tool, use T (current value): T or TN, ST (current value): ST or STN, C (current value): C or CN, and LC (current value): LC or LCN.

Point

Trigger logging does not require the configuration of these settings because the stack file is automatically switched to a storage file after as much data as the specified number of records is written into the stack file. Special relay (logging data storage file switching in progress) can be used to check if storage file switching is in progress.

Storage file

The CPU module creates a subfolder ("storage file container folder") under the file storage folder and writes storage files to that storage file container folder. One storage file container folder can contain up to 256 storage files. When the files contained in the current storage file container folder reach the maximum number, the CPU module creates a new storage file container folder at the time of next storage file switching and begins writing storage files to that new folder. The number of files that can be contained in one file storage folder is configurable within the range of 1 to 65535.

Point

The base folder name of a storage file container folder is an eight-digit (hexadecimal) number. This number matches the lowest of the serial numbers of the files contained in the directory. Date and time stamps can be appended to the folder name.

Action to take when the maximum number of storage files is exceeded

Either "Overwrite" or "Stop"^{*1} can be selected as the action to take when the maximum number of storage files is exceeded.

*1 This settings is not configurable for trigger logging.

■When "Overwrite" is selected

When the storage file switching condition is met after the specified maximum number of storage files is exceeded, the CPU module deletes the file with the lowest serial number and creates a new file that has a serial number incremented by one from the highest serial number, allowing data logging to continue. In addition, if deleting the file with the lowest serial number results in an empty folder, the CPU module deletes that folder as well.

■When "Stop" is selected

As described in the following table, the action differs depending on when the specified maximum number of storage files is exceeded.

Occurrence timing	Occurrence condition	Operation
When data logging is started	There exist more storage files than the specified maximum number when data logging is started.	<ul style="list-style-type: none"> If an attempt is made to register the data logging settings from within the CPU Module Logging Configuration Tool, an error is generated, resulting in failure to run data logging. If an attempt is made to register^{*1} the data logging settings from outside the CPU Module Logging Configuration Tool, the special relay (data logging error) turns on and the special register (data logging error cause) stores the cause of the error, resulting in failure to run data logging.
While data logging is running	The specified maximum number of storage files is reached due to file switching upon the satisfaction of the storage file switching condition.	Data logging stops and enters into the completion state. The special relay (data logging completed) turns on to indicate that data logging is completed.

*1 When an attempt is made to register the data logging settings again, the CPU module enters into the data logging completed state. The special relay (data logging completed) turns on to indicate that data logging is completed.

Internal buffer

The internal buffer is a system area used to temporarily store collected data.

■Internal buffer capacity setting

FX5U/FX5UC CPU module can change the internal buffer capacity with an engineering tool. (☞ Page 128 INTERNAL BUFFER CAPACITY SETTING) For trigger logging, increasing the internal buffer capacity allows for a larger number of data records collected before a trigger and also helps to prevent processing overflow. If the free space in the internal buffer is still insufficient after increasing the internal buffer capacity, use the following workarounds:

- Increase the data collection interval or timing.
- Reduce the number of data records to be collected.
- Lower the frequency of file switching.

Precautions

When changing the capacity of the internal buffer during execution of the data logging function, pay attention to the followings.

- If the internal buffer capacity field for the running setting No. is left blank so that the internal buffer capacity for the setting No. will not be used, an error will occur when the data logging is resumed after it is stopped. (An error will not occur when data is written to the CPU module.)
- If the internal buffer capacity for the running setting No. is changed to a value smaller than the set value, some data may be lost when the data logging is resumed after it is stopped.

■Amount of internal buffer consumed

This value can be calculated by multiplying "Number of data points" by 2 bytes. Note, however, that additional space is consumed by columns configured for output, as indicated below:

- Date/time column: 10 bytes
- Data collection interval column: 8 bytes
- Index column: 4 bytes

Ex.

When data logging is configured to collect as much data as one setting x 128 records and output all of the columns (i.e., maximum allowable configuration):

$$128 \times 2 + (10 + 8 + 4) = 278 \text{ bytes}$$

Setting the operation at the time of transition to RUN

This function configures the operation of data logging that occurs when the user performs the following operations (transition to RUN) after the data logging setting are registered. (☞ Page 561 Logging operation)

- Turning off and on the CPU module and switching to the RUN mode
- Resetting and running the CPU module
- Stopping and running the CPU module

Point

The operation at the time of transition to RUN can be set individually for each setting number (1 to 4).

Operation at the time of transition to RUN

The operation at the time of transition to RUN can be set to either of the followings.

■Auto start

After the user performs one of the operations listed above, data logging automatically starts when the operating status of the CPU module changes from STOP to RUN.

Point

To first start data logging, the user must instruct the CPU Module Logging Configuration Tool to start data logging.

■Start by user operation

After the user performs one of the operations listed above, the data logging state is switched to "Waiting start Not collected" when the operating status of the CPU module changes from STOP to RUN. To start data logging again, the user must instruct the CPU Module Logging Configuration Tool to start data logging.

Data logging operation that occurs after operating status of CPU module has changed

Data logging does not continue when the operating state of the CPU module changes from RUN to STOP or PAUSE after it has been started. The data logging state changes to "Waiting RUN Not collected" and data collection is stopped.

20.3 Procedure for Using

System configuration

Describes the system configuration when using the data logging function.

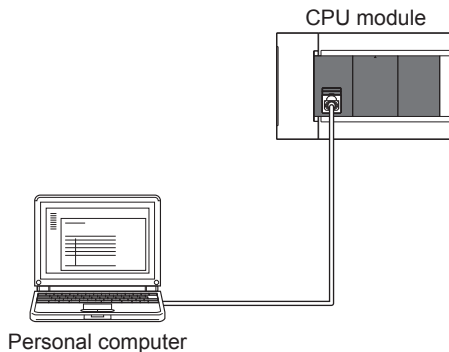

Software

Describes the software used for the data logging function.

Name	Description
GX Works3	Software for PLC system design, programming, debugging, and maintenance.
CPU Module Logging Configuration Tool	This software is used for configuration and maintenance of the data logging.
GX LogViewer	This software graphically displays data collected by the data logging function.

Point

GX LogViewer is not an essential tool for using the data logging function. Use this tool for various objectives, such as graphically displaying data logged by this function. GX LogViewer is beyond the scope of this manual unless it specifically relates to the topic of this manual. For details on GX LogViewer, refer to the following:

GX LogViewer Version 1 Operating Manual

Outline of procedure

The outline of the data logging procedure is shown below.

Procedure	Item	Description
1	Data logging setting	Configure the function with the CPU Module Logging Configuration Tool. To configure with the CPU Module Logging Configuration Tool, select displayed items or enter values.
2	Writing the data logging setting	Write the settings to the CPU module.
3	Executing data logging	Execute data logging. Data logging can be executed by the following methods. <ul style="list-style-type: none">• Execution by CPU Module Logging Configuration Tool• Execution by special relay
4	Checking the data logging file	Check the data logging file.

Data logging setting

1. Confirm that Function to Use Internal Buffer of GX Works3 is “Data Logging Function”.

Navigation window ⇒ [Parameter] ⇒ [The model of the CPU module] ⇒ [CPU Parameter] ⇒ [Memory/Device Setting]

Item	Setting
Internal Buffer Capacity Setting	
Total Capacity	320 K Byte
Function to Use Internal Buffer	Data Logging Function

2. Start the CPU Module Logging Configuration Tool.

[Tool] ⇒ [Logging Configuration Tool]

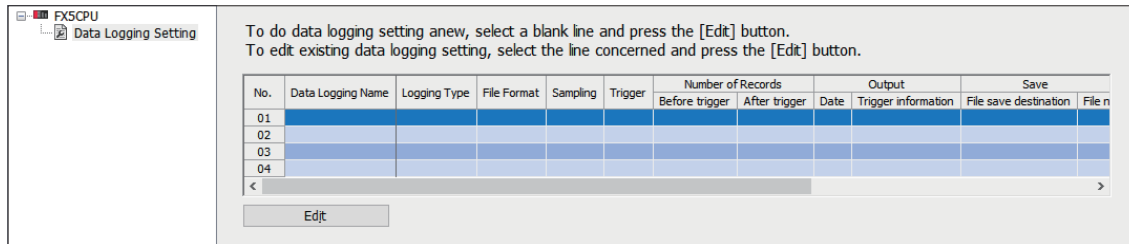

3. Click the [Edit] button to open the data logging setting screen.

Set the items necessary for using the data logging function in the wizard window.

For the details of the setting items, refer to the following table.

Set item		Reference
Logging type	Logging type	Page 146 Logging type
	File format	Page 153 Data logging file
Sampling	Sampling interval	Page 148 Data collection conditions
Data	Device	Page 151 Data to be collected
	Data type	Page 151 Data type
	Output format	For details, refer to the following. Page 153 CSV file format* ² Page 157 Binary file format
Trigger* ¹		Page 152 Trigger condition
Number of records* ¹		Page 147 Logging type
Output		For details, refer to the following. Page 153 CSV file format* ² Page 157 Binary file format
Save	Logging file save setting	Page 560 Save
	File switching setting	Page 161 Switching to a storage file
Movement		Page 165 Setting the operation at the time of transition to RUN
Finish		—

*1 Set these items when the trigger logging is selected for the logging type.

*2 This format is applicable only to the FX5U/FX5UC CPU module.

Writing the data logging setting

1. Insert an SD memory card into the CPU module, and turn on power.
2. Write the settings to the data memory or SD memory card.

 [Online] ⇄ [Write Logging Setting]

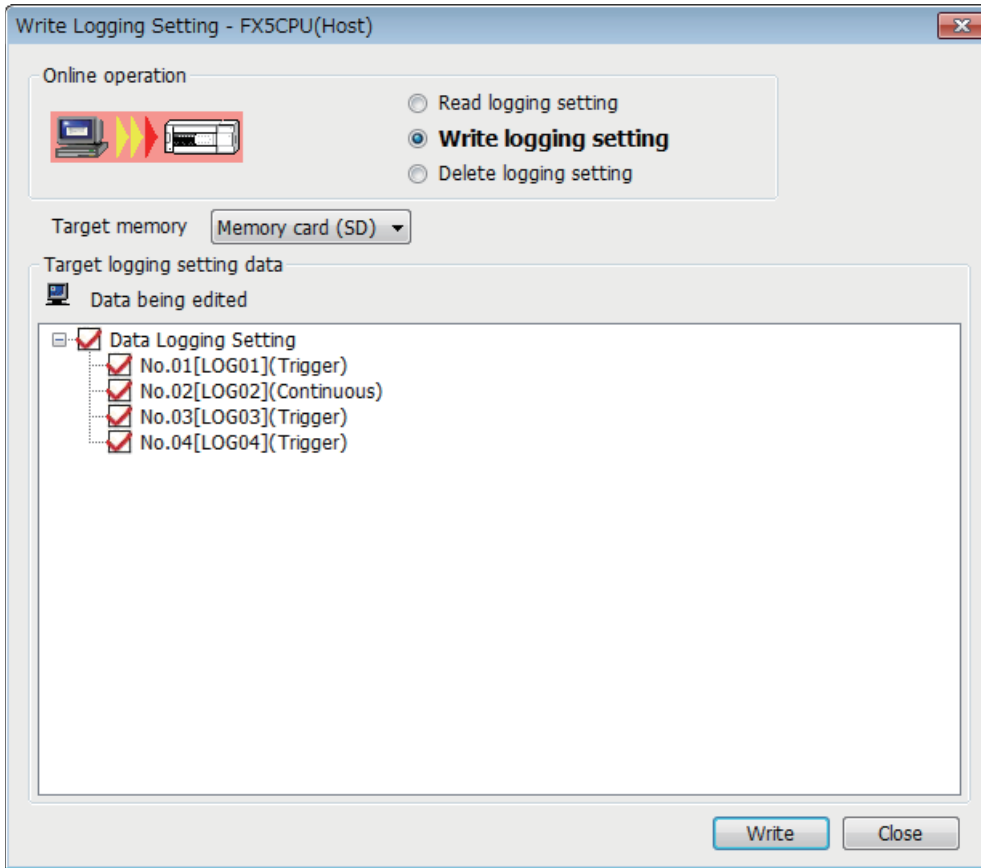

Executing data logging

Point

Data logging can be executed also by using the special relay. For details, refer to the following.

☞ Page 171 Data Logging Execution by Special Relay

1. Set the CPU module to the RUN status.
2. Open the “Logging Status and Operation” window.
🔗 [Online] ⇒ [Logging Status and Operation]
3. Check the target setting No. (Multiple selection possible)

Target	No.
<input type="checkbox"/>	01
<input type="checkbox"/>	02
<input type="checkbox"/>	03
<input type="checkbox"/>	04

4. Start the data logging by clicking the [Start] button. (When multiple items are selected, they are executed simultaneously.)

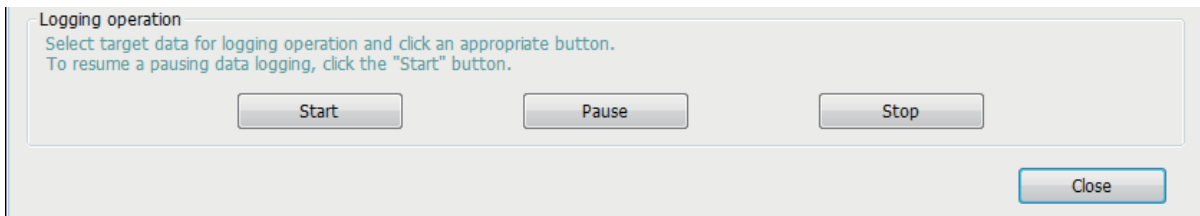

5. The logging status is displayed in “Logging Status”.

Logging Status	
Collection completed	...
Collecting	...
Pause	...
Stop (Normal)	...

For the logging status, refer to the following.

☞ Page 551 Logging status and operation

Checking the data logging file

1. Stop the data logging.

[Online] ⇒ [Logging Status and Operation]

Select the data logging setting to be checked, and click the [Stop] button.

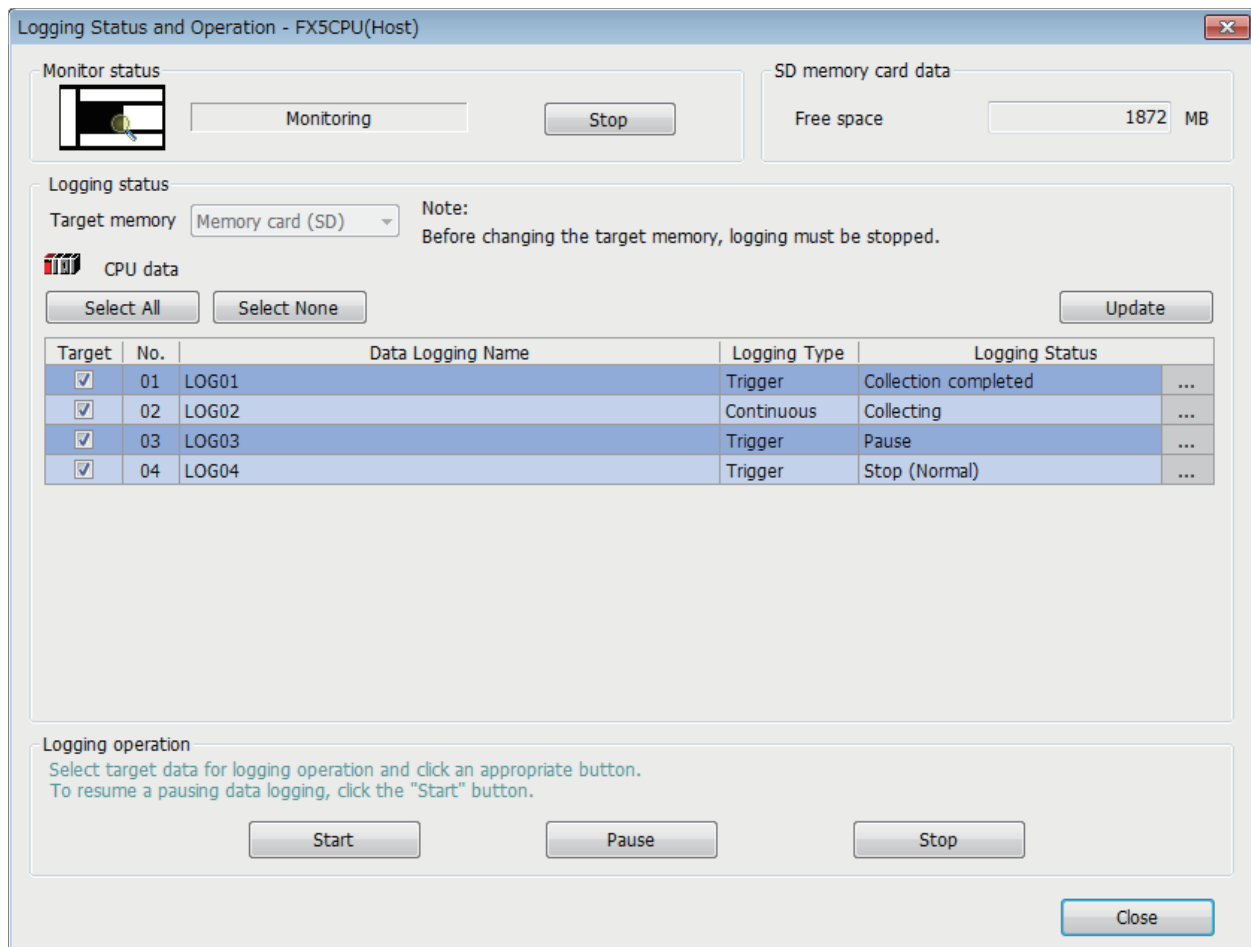

2. Open the “Logging File Operation” window.

[Online] ⇒ [Logging File Operation]

Specify the directory and select the target file.

Click the [Save to PC] button.

3. Check the file saved to the personal computer.

20.4 Data Logging Execution by Special Relay

The data logging setting can be registered by the special relay and be executed on the data logging setting file stored in the SD memory card. Note that this operation can be used together with each operation of the CPU module logging setting tool. (☞ Page 551 Logging status and operation)

Operating procedure

1. Write the effective setting data to the SD memory card with CPU module logging setting tool.
2. If the special relay with the target setting No. (Data logging register/clear flag) to be executed is turned ON, the setting data in the SD memory card will be registered.
3. If the special relay with the target setting No. (Data logging suspend/resume) is turned OFF, the execution of data logging will start. (Multiple execution can be performed simultaneously.)
4. To suspend the data logging, turn ON the special relay with the target setting No. (Data logging suspend/resume). To stop the data logging, turn OFF the special relay with the target setting No. (Data logging register/clear).

Point

- The data logging cannot be started even when writing the setting and turning power off and on or resetting. To start the data logging, make sure to turn ON the special relay (Data logging register/clear flag), and turn OFF the special relay (Data logging suspend/resume).
- With regards to the trigger logging, the data logging setting registration attempt fails if the trigger condition is satisfied.
- It takes a certain amount of time to stop or suspend the data logging after either of these commands is issued by special relay (because the data logging is not stopped or suspended unless the data stored in the internal buffer data has been transferred into the SD memory card in response to these commands).
- There may be a case where a time-out error occurs and the data logging is suspended after special relay starts the logging.

Precautions

The data logging cannot be executed by the special relay on the data logging setting file stored in the data memory.

Data logging resume

When an error occurs during the data logging execution, the following operation is required to resume the data logging from the program, etc.

Operating procedure

1. Clear the cause of error, turn OFF the special relay (Data logging register/clear), and set the data logging status to the disable status.
2. After confirming the special relay (Data logging preparation) is OFF, turn ON the special relay (Data logging register/clear flag).
3. After confirming the special relay (Data logging preparation) is ON, turn OFF the special relay (Data logging suspend/resume).

Special relay and special register used by the data logging function

For details on the special relays and special registers used by the data logging function, refer to the following:

- Special relay: Special relay related with the data logging function (☞ Page 380, Page 408)
- Special register: Special register related with the data logging function (☞ Page 420, Page 456)

20.5 Precautions

This section describes precautions to take when using the data logging function.

Missing data

The term "missing data" means that some of the collected data is missing, resulting in data discontinuity.

Missing data occurs under the following conditions:

Item	Description
Processing overflow	<ul style="list-style-type: none"> When the internal buffer responsible for tentatively storing the logged data is unable to store new logged data because the SD memory card does not store data When you attempt to register the data logging while the CPU module is in the process of logging collecting, collecting before trigger or collecting after trigger
Operations for the CPU module	The CPU module has been stopped and run with "Operation at transition to RUN" set to "Auto Start."
	The CPU module has been turned off and on with "Operation at transition to RUN" set to "Auto Start."
	The CPU module has been reset and run with "Operation at transition to RUN" set to "Auto Start."
Operation from engineering tools, CPU Module Logging Configuration Tool, and external devices via protocols such as SLMP	<ul style="list-style-type: none"> When the CPU module is suspended and restarted, and operation for displaying the logging state is performed from CPU Module Logging Configuration Tool File read^{*1}, write, delete, or verification

*1 The following operation also is included:

- Online operation which displays data by operation such as read from the PLC performed from an engineering tool (retrieval and display of a list of files on the CPU module)
- View of the event history (retrieval of the event history from the CPU module)

■ Processing overflow

In normal cases when the usage of the internal buffer reaches the specified maximum capacity, the CPU module overwrites the data stored in the storage memory on a first-in first-out basis. If the internal buffer becomes full before all of the data stored in it is saved to the storage memory, however, the CPU module does not overwrite the existing data and stops storing data in the internal buffer, thus resulting in missing data. This situation is referred to as processing overflow. Upon the occurrence overflow, the special register (Number of processing overflow occurrences) stores the number of times when processing overflow occurred.

Errors generated during data logging

No diagnostic error occurs if an error occurs during data logging, the SM applicable to the special relay (data logging error) setting No. turns on, and the error cause is stored in the SD applicable to the special register (data logging error cause) setting No. Note that if the data logging with the special relay fails at the time of register/clear, the cause of occurred error is stored in a special register (the data logging register/clear error code) applicable to the setting No.

Mutual exclusion of the data logging function

This section describes the mutual exclusion of the data logging function.

■ When another function is executed during the execution of the data logging function

The following table lists the cases when another function is executed during the execution of the data logging function.

Function that has been already executed	Function to be executed later	Operation
Data logging function	Data logging function	<p>When the data logging is started using the CPU Module Logging Configuration Tool to the same data logging setting number, the data logging to be executed later cannot be executed. However, the data logging to be executed later can be executed to a data logging setting number different from the data logging setting number currently being executed.</p> <p>For the execution of multiple data loggings, the data logging settings stored in different target memory areas cannot be executed at the same time.</p>
	Memory dump function	The data logging function and memory dump function cannot be used simultaneously.
	Data backup function	The data backup function cannot be executed while a logging setting file is being written/ deleted or a logging setting is being registered/cleared.
	Data restoration function	The data restoration function cannot be executed while a logging setting file is being written/ read/deleted or a logging setting is being registered/cleared.

■When the data logging function is executed during the execution of another function

The following table lists the cases when the data logging function is executed during the execution of another function.

Function that has been already executed	Function to be executed later	Operation
Memory dump function	Data logging function	The data logging function and memory dump function cannot be used simultaneously.
Data backup function		While the data backup function is being executed, a logging setting file cannot be written/deleted and a logging setting cannot be registered/cleared.
Data restoration function		While the data restoration function is being executed, a logging setting file cannot be written/read/deleted and a logging setting cannot be registered/cleared.

Locations from which data logging can be performed

Data logging cannot be performed from multiple locations to the same setting number. The CPU module supports data logging performed concurrently at a maximum of 4 locations assigned to setting numbers 1 to 4.

Retention and clearance of data logging settings

The data logging settings registered in the CPU module are latched and thus survive across a power cycle (power off and on) or reset of the CPU module in normal cases. In the following cases, however, the data logging status is cleared to the unregistered state and therefore the setting data must be written again:

- The CPU module is turned off and on or reset without an SD memory card that contains the data logging setting file.
- The replaced SD memory card does not contain the data logging setting file and the CPU module is turned off and on or reset.^{*1}

*1 If the data logging setting file contained in the replacement (new) SD memory card is different from that contained in the replaced (old) SD memory card, the data logging setting file contained in the replacement SD memory card becomes registered.

Stopping/suspending data logging

After data logging is stopped or suspended from within the CPU Module Logging Configuration Tool or special relay, all the data in the internal buffer is written into the target memory. If a small number of records or a small file size is specified as part of the storage file switching condition, writes to the target memory may take a longer time.

Operation against the failure to register data logging setting files

When an attempt to register multiple data logging setting files at the same time is made and fails for some of them, the CPU module runs data logging for the setting files that have been successfully registered.

Numbering of the storage files used during data logging

If one or more numbered storage files already exist in the specified file storage folder and a new file is written, the new file is given a file name that uses a number incremented by one from the highest number among the existing files. If the file storage folder has no storage files but one or more storage file container folders exist, the new file is stored under the folder with the lowest number and it is given the same number as the folder. However, if there are 258 or more folders under the said conditions, a new folder is created and the file is given the same number as the new folder.

Operation that occurs while collected data is stored in the target memory

If one of the following operations is performed while collected data is stored in the target memory, any unsaved data is cleared and not reflected to the results:

- Turning power of the CPU module off and on
- Reset

If one of the following operations is performed, unsaved data continues to be stored in the target memory:

- Stopping the CPU module
- Stopping/suspending data logging from within the CPU Module Logging Configuration Tool
- Issuing the LOGTRGR instruction

Creating files and folders

Under the "LOGGING" folder that contains data logging setting files and data logging files, do not attempt to create files or folders using a personal computer or other device. Doing so may result in deletion of files and folders.

Changing the clock data

Whatever changes, such as advancing or reverting the clock, are made to the clock data of the CPU module during data logging, the CPU module performs data collection at the specified collection interval/timing, but the date/time column in the output file reports the changed clock data.

Access to the SD memory card

If data logging is performed with a small setting of the data collection interval/timing or with a large number of records to be collected, access (read/write) to the SD memory card occurs so frequently that a delay occurs in completing the access. To avoid such a delay, use the following workarounds:

- Increase the data collection interval/timing.
- Reduce the number of data records to be collected.
- Lower the frequency of file switching.

Changing the operating status of the CPU module

The operating state of the CPU module should not be changed until the completion of the following operations and registrations:

- Save of the data in the internal buffer by changing the state of the CPU module from RUN to STOP or instructing the CPU Module Logging Configuration Tool to stop or suspend the CPU module
- Registering multiple data logging sessions' settings^{*1}
- Registering data logging settings with any unused folders remaining in the storage memory^{*1}

^{*1} Data logging settings are also registered when the CPU module is stopped and run.

Point

- To shorten the time required to register multiple data logging sessions' settings, reduce the number of data logging sessions.
- To shorten the time required to register data logging settings with any unused folders remaining in the storage memory, delete the unused folders before registration.

File operation during execution of data logging

Describes file operation during execution of data logging.

Target file	File operation	Operation
Data logging setting file	Write	During execution of data logging, it is not possible to write or the delete data logging setting file being used.
	Delete	
	Initialize	During execution of data logging, it is not possible to initialize the memory storing the data logging setting file being executed.
	Folder delete	Folders cannot be deleted from the \$MELPRJ\$ folder in which the data logging setting file is stored.
Data Logging File	Write	During execution of data logging, it is not possible to write or delete data, or delete folders corresponding to the data logging setting file being used.
	Delete	
	Folder delete	
	Initialize	During execution of data logging, it is not possible to initialize the memory storing the data logging setting file being executed.

About remote operation

When remote RUN is performed while the data logging function is in the following execution status, the remote RUN may fail. In that case, wait for a while and retry remote RUN. If remote RUN still cannot be executed, check whether remote RUN is acceptable and retry remote RUN.

Execution state of data logging function	The situation to accept remote RUN
Data saving into memory card in progress	No special relay (Data logging data saving into memory card in progress) is on.
Registration of the data logging setting from CPU Module Logging Configuration Tool in progress	The special relay (data logging preparation) and the special relay (data logging start) corresponding to the setting number of the data logging setting, which is being registered in the way shown in the left column, are on.

RUN operation through switching operation or the RUN contact

During execution of data logging, when the status of the CPU module is switched from STOP to RUN with the RUN/STOP/RESET switch, or when remote STOP to RUN operation of the RUN contact, it may take time to return to the RUN state.

20.6 SD Memory card Life and Replacement

This section describes the life of the SD memory card used for the data logging function and the replacement procedure.

SD memory card life

An SD memory card has a life (restriction on writing data). The following shows the calculation method of an SD memory card life when the data logging function is used. Note that the actual life of the card varies depending on usage conditions and environment. Therefore, use the calculated life as a rough standard for the replacement of the card.

Calculation formula of SD memory card life

SD memory card life (year) = Total size of data that can be written (G bytes) ÷ Size of data to be written per year (G bytes/year)

Total size of data that can be written

Capacity × Number of writes

For the capacity of applicable SD memory cards and the number of writes, refer to the following.

📖 MELSEC iQ-F FX5UJ User's Manual (Hardware)

📖 MELSEC iQ-F FX5U User's Manual (Hardware)

📖 MELSEC iQ-F FX5UC User's Manual (Hardware)

Size of data to be written per year

The size of data to be written per year is obtained by the following formula.

Size of data to be written per year (G bytes/year) = $((DS1^{*1} + 6144) \times DN1 + \dots + (DSn^{*1} + 6144) \times DNn + (DCS1^{*1} + 6144) \times DCN1 + \dots + (DCSn^{*1} + 6144) \times DCNn) \div 1073741824$

*1 Round up DS_n and DCS_n to a multiple of 512.

DS_n, DN_n, DCS_n, and DCN_n are obtained as follows.

■Data logging data size per record (DS_n)

CSV file output format: Refer to the data. (📖 Page 153 CSV file format)

Binary file output format: Refer to the data. (📖 Page 157 Binary file format)

■Number of records for data logging per year (DN_n)

Continuous logging: $DNn = 60 \times 60 \times 24 \times 365 \div \text{Collection interval and timing (seconds)}^{*1} \times \text{Operating rate}^{*2}$

Trigger logging: $DNn = \text{Total number of records}^{*3}$

*1 The value that is determined depending on the condition set in "Sampling" when "Continuous logging" is selected for the logging type. (When the value is determined in milliseconds, convert the value into seconds.)

*2 Calculate the ratio using the operating time per year of the CPU module. For example, if the operating time per year is 5000 hours, the operating rate is calculated as follows: $5000 \div (24 \times 365) = 0.57$.

*3 The value set in "Number of logging lines" when "Trigger logging" is selected for the logging type.

■Header size of data logging (DCS_n)

CSV file output format: Refer to the header. (📖 Page 153 CSV file format)

Binary file output format: Refer to the header. (📖 Page 157 Binary file format)

■Number of file switching times for the data logging per year (DCN_n)

Calculate this number with an estimated number according to the save setting of the data logging and system operations. For example, when 1000 records are set in "Number of records" of "File switching timing" in the save setting and "Each scanning cycle" is specified for "Sampling interval" in the sampling setting, the time interval of the file switching is obtained by multiplying the scan time by 1000. Therefore, the number of file switching times for the data logging per year is obtained by the following formula: $60 \times 60 \times 24 \times 365 \div (\text{Scan time (second)} \times 1000)$.

SD memory card replacement

SD memory cards can be replaced using the SD memory card forced disable function even while data logging is in progress. (Page 137 SD Memory Card Forced Stop) This function works by disabling data writes to the SD memory card while allowing data collection to continue. (Data collection continues in accordance with the settings registered when data logging is started.)

Point

If SD memory card replacement causes processing overflow, make adjustments by changing the collection interval, internal buffer capacity, or other settings.

Operation during SD memory card replacement

Mounting the replaced SD memory card on the CPU module causes a "LOGGING" folder to be created. When becoming ready for running the logging function, the CPU module resumes the data transfer into the SD memory card.

The CPU module operates differently as follows depending on the folder configuration in the replaced SD memory card.

Folder constitution	Operation of after SD memory card replacement
The folder not exist.	LOGGING folder is made.
Only LOGGING folder	<ul style="list-style-type: none">• LOGGING folder is renamed by LOGGING_OLD.• LOGGING folder is made.
Only LOGGING_OLD folder	LOGGING folder is made.
LOGGING folder LOGGING_OLD folder	Data logging state changes to error state.

Precautions

If the internal buffer becomes full during the time between SD memory card replacement and the resumption of data writes to the SD memory card, processing overflow occurs resulting in missing data.

Storage file numbers after SD memory card replacement

The numbering of the first storage file created after SD memory card replacement differs depending on the storage file switching condition, as described in the following table.

Storage file switching condition	Storage file numbers after SD memory card replacement
Overwrite	Numbering continues from the number of the last storage file contained in the replaced SD memory card.
Stop	Numbering begins at 00000001.

Point

If the new SD memory card contains a "LOGGING" and "LOGGING_OLD" folder, data logging cannot be executed. Ensure that the new SD memory card does not contain a "LOGGING" and "LOGGING_OLD" folder.

Logging state during SD memory card replacement

SD memory cards can be replaced without depending on the current data logging state.

Operations during SD memory card replacement

If one of the following operations is performed during the time between the removal and installation of SD memory cards, any data collected during that time will not be stored in the new SD memory card.

- Stop and run*1
- Power off and on*1
- Reset*1
- Suspend data logging
- Stop data logging

*1 An error is generated if data logging was previously running based on the setting file contained in the replaced SD memory card.

Operations after SD memory card replacement

If the SD memory card was replaced while data logging was running based on the data logging setting file contained in the SD memory card, the data logging setting file contained in the new SD memory card is used when data logging is started next. If the new SD memory card does not contain the data logging setting file, data logging is not started.

Stack file remaining in the replaced SD memory card

Replacing an SD memory card that contains a stack file may result in the stack file remaining in the replaced SD memory card along with storage files. If the stack file is remaining in the replaced SD memory card, recover the latest data contained in the stack file by doing the following:

- Retrieve the data from the stack file and combine the data with a storage file.
- Save the stack file as a storage file.

21 MEMORY DUMP FUNCTION

This function stores device values of the CPU module at any given timing. Checking data at the desired timing through the function facilitates the analysis of problems which occur depending on a particular condition.

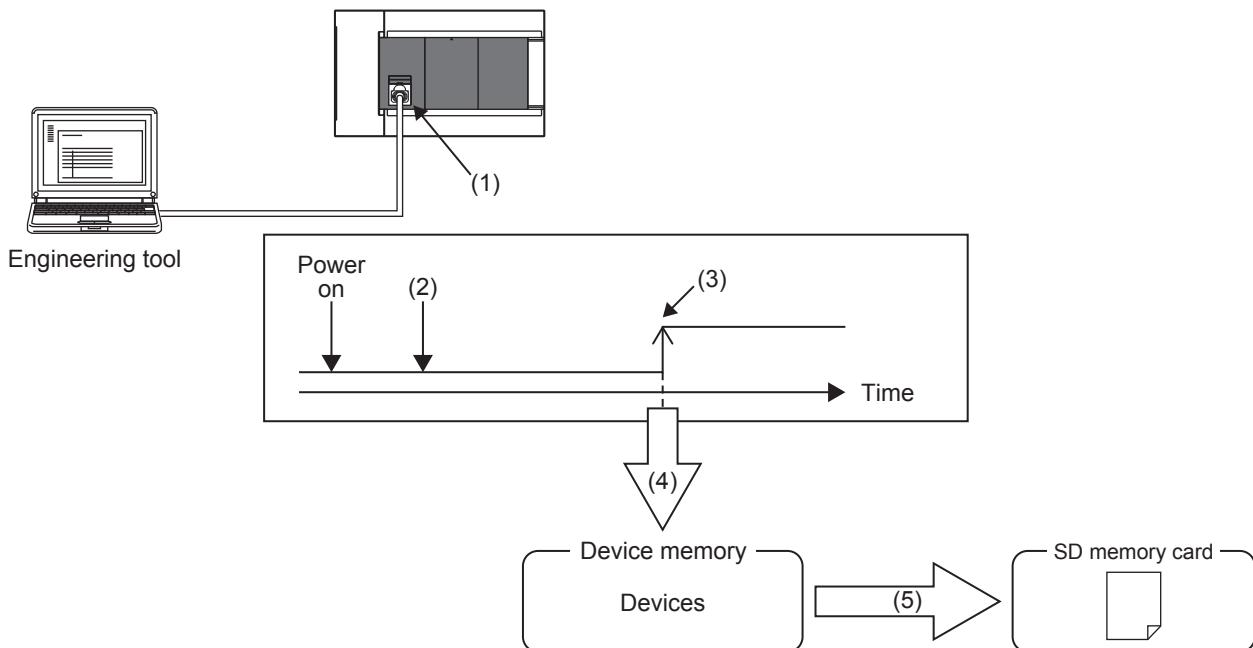

- (1) Perform memory dump settings.
- (2) Enters a wait state for the trigger after the memory dump setting file has been written.
- (3) Establishment of the trigger condition
- (4) Start of data collection
- (5) The memory dump file is stored in the SD memory card. (☞ Page 184 Memory Dump File)

Point

For supported version of memory dump function, refer to ☞ Page 566 Added and Enhanced Functions.

Restriction

- This function can be used only when the internal buffer usage function is set to "memory dump function". (☞ Page 128 INTERNAL BUFFER CAPACITY SETTING)
- Memory dump can be performed only between the same models. (FX5U CPU module and FX5UC CPU module are treated as the same models.)

21.1 Object Data

This section describes the data to be collected by memory dump.

Data to be collected

Of the devices listed below, all devices that are within the range specified in the device settings are subject to the collection.

Type	Device
Bit device	X, Y, M, L, B, F, SB, T (contact), T (coil), ST (contact)*, ST (coil), C (contact), C (coil), LC (contact), LC (coil), S, SM, BL□\S□ ^{*1}
Word device	T (current value), ST (current value), C (current value), D, W, SW, SD, R, Z
Double-word device	LC (current value), LZ

*1 Only FX5U/FX5UC CPU module is supported.

Point

For BL□\S□ (step relay with block specification), data collection is performed only when the SFC program exists. (MELSEC iQ-F FX5 Programming Manual (Program Design))

21.2 Trigger Condition

The following table lists the conditions to be used as a trigger. Set the trigger condition in the memory dump settings. (GX Works3 Operating Manual)

Trigger condition	Description
Device specification	Data are collected when the specified monitoring target data (bit data) turns on during the END processing.
At the occurrence of an error	Data is collected using the SM0 (latest self-diagnosis error) OFF→ON as the trigger.

Precautions

On the occurrence of consecutive triggers, if the status of data save due to the previous occurrence of trigger is "Save complete" of collected data, the next trigger is recognized as a trigger again. Note that events other than the above are not recognized as a trigger condition.

Point

A trigger can be generated with trigger conditions combined. (Page 182 Combining trigger conditions)

Device specification

Data are collected when the specified monitoring target data turns on during the END processing.

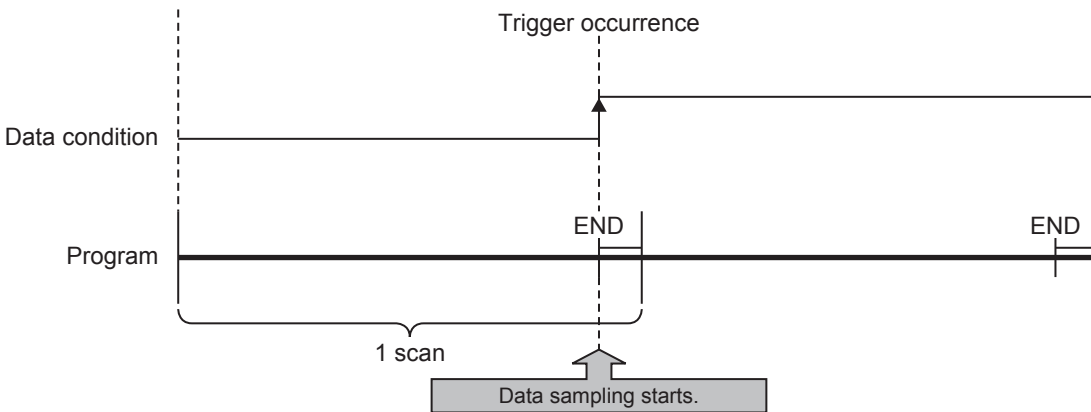

For monitoring data, the following devices can be specified.

Type	Device ^{*1}
Bit device	X, Y, M, L, F, SM, B, SB, T (contact) ^{*2} , ST (contact) ^{*2} , C (contact) ^{*2} , LC (contact) ^{*2}

*1 Index modification, and indirect specification cannot be specified.

*2 To specify these devices with the engineering tool, use T (contact): TS, ST (contact): STS, C (contact): CS, and LC (contact): LCS.

Precautions

Even though the value of the monitoring target data changes during a single scan, if the value during the END processing is same as that during the last END processing, it is not recognized as a trigger.

At the occurrence of an error

Data is collected using the SM0 (latest self-diagnosis error) OFF→ON as the trigger.

The trigger occurs at the END process of the scan in which the error occurred.

At the occurrence of a continuation error

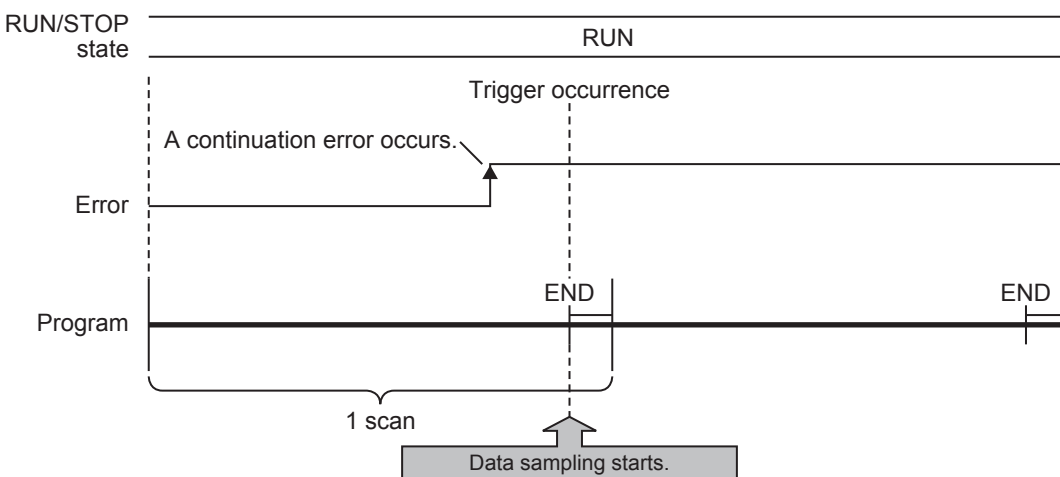

Precautions

If the same continuous error occurs after SM0 turns ON, it will not be recognized as a trigger, so data will not be collected. Being recognized as a trigger requires the error to be cleared.

At the occurrence of a stop error

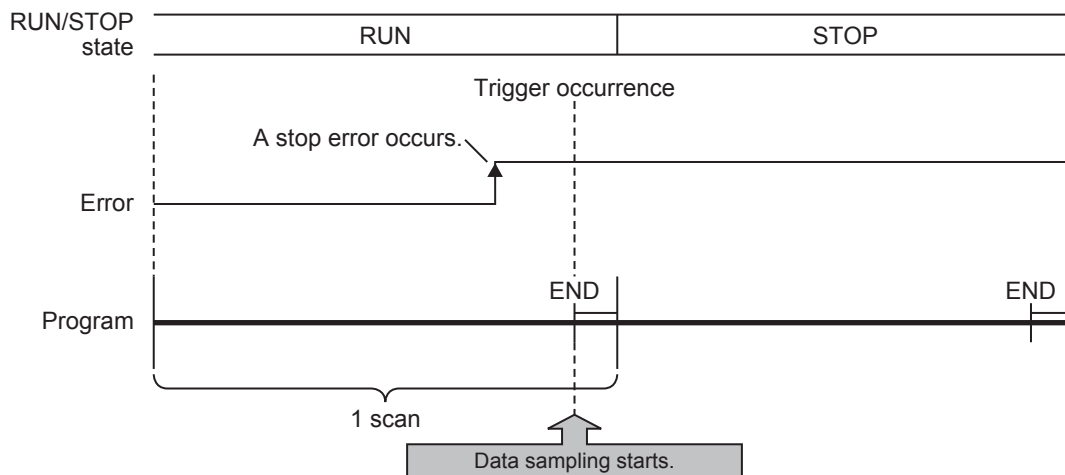

Point

Even if an error occurs, if the function (analog function, etc.) does not cause SM0 to turn ON, memory dump using SM0 as the trigger cannot be executed. By specifying a device for each function's error display with the device specification, memory dump can be executed even when an error occurs in a function that does not cause SM0 to turn ON.

Combining trigger conditions

A trigger can be generated with trigger conditions combined. This combination is based on an OR condition. The establishment of a condition, either device specification or error code specification, results in data collection.

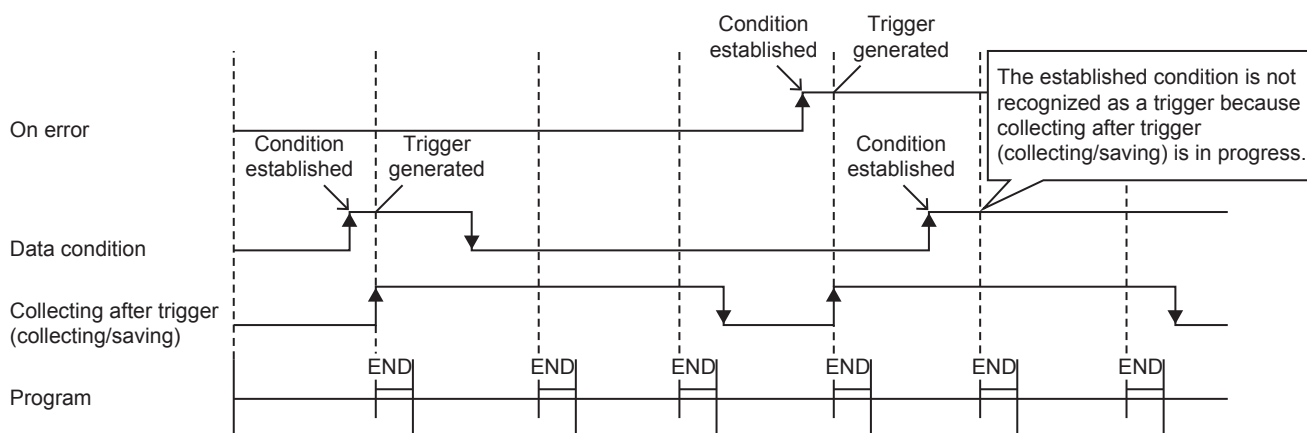

Precautions

If the trigger conditions are established again during data collection, the state will not be recognized as a trigger so data will not be collected.

Point

If the trigger conditions for both device specification and error occurrence are established within the same scan, the trigger conditions for error occurrence will have priority.

21.3 Procedure for Memory Dump

This section describes the procedure for memory dump. Note that each operation of the memory dump function is performed with the engineering tool.

 [Debug] ⇄ [Memory Dump]

For how to view and operate the window, refer to the following.

 GX Works3 Operating Manual

1. Configure the memory dump settings by the menu operation in the engineering tool.
2. Writing the memory dump setting file results in a wait state for the trigger. Whether the CPU module is in a RUN state, STOP state (including stop error^{*1}), or PAUSE state, a wait state for the trigger results.

*1 Limited to where the trigger condition is device specification.

Point

- If the memory dump setting file is stored, the memory dump will be executed when the CPU module power is turned OFF→ON or reset.
- The engineering tool allows the memory dump status to be checked.

3. Establishment of the trigger condition initiates data collection, saving the memory dump file to the SD memory card.
4. The contents of the memory dump file (collected device data) can be checked with the engineering tool.

21.4 Flow of Data Collection

Collected data is stored in the internal buffer, where the data is partitioned at END processing and saved in the SD memory card. When a trigger is generated, the END process will take longer than usual.

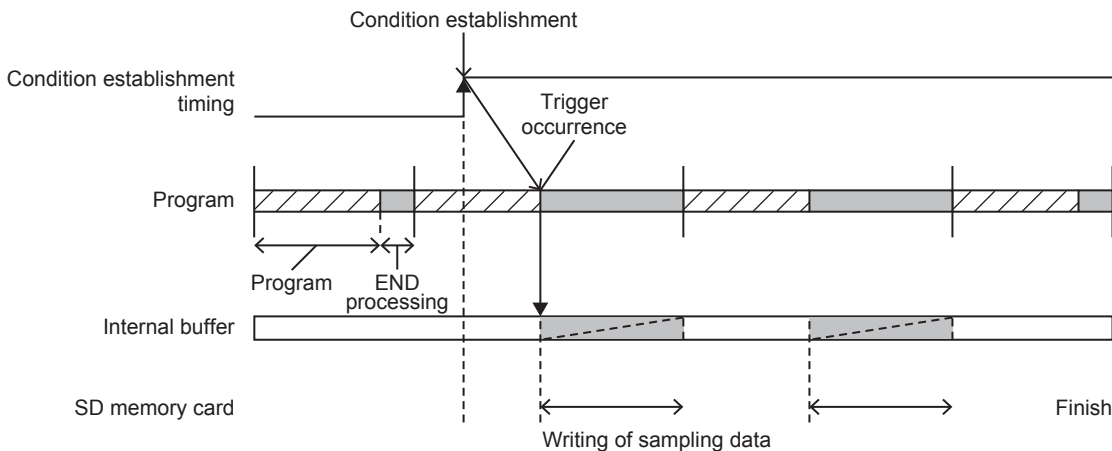

Precautions

- If a user interrupt occurs while transferring the device data to the internal buffer, a data inconsistency will occur.
- If a user interrupt occurs while transferring double-word devices, an inconsistency will occur in the high-order and low-order word devices.

Effect on the scan time

If the memory dump function detects a trigger, the scan time will increase as follows when collecting the data.

- FX5UJ CPU module: Approx. 25 ms
- FX5U/FX5UC CPU module: Approx. 15 ms (Approx. 16 ms if SFC program exists)

21.5 Memory Dump File

This file stores data that is collected through memory dump (collection result by memory dump). Data collected by one execution is saved in one file. The memory dump file is saved in a binary format and stored under the "MEMDUMP" folder.

Save file name

The file name can be arbitrarily set within a range of 64 characters (extension and period included) together with an autoassigned number (00 to 99). Specify the save file name in the memory dump settings. (GX Works3 Operating Manual)

Ex.
MEMDUMP_00*1

- *1 Between a specified file name (MEMDUMP) and an auto-assigned number (00), the single-byte underbar (_) is added.
If a file name with 5 or less characters is specified, the lowercase characters used in the file name may be handled as uppercase characters.

When the memory dump function is registered, the debug folder (DEBUG (fixed)) and the memory dump folder (MEMDUMP (fixed)) are created in the SD memory card. The memory dump file (result file) is stored in the memory dump folder. One folder can contain a maximum of 100 files. If any file does not exist in creating a save file, the file with the number 00 is created. If any file already exists in creating a save file, the behavior is as follows:

Number of files	Behavior
For less than 100	Creates a file*2 assigning the number obtained by adding 1 to the number of the file where the creation date and time is the latest.
For 100 (maximum)	Deletes the file where the creation date and time is the oldest and creates a new file using the deleted number as it is.

- *2 If the corresponding file number is 99, a file with file number 00 is created.

21.6 States of the Memory Dump Function

The state of the memory dump function is reflected in the memory dump status. The engineering tool allows the memory dump status to be checked. (GX Works3 Operating Manual)

Memory dump status

The following table lists the memory dump status.

Memory dump status	Description
Stop	State in which memory dump is not registered
Trigger-wait not collected	A state in which data is not yet collected and establishment of the trigger condition is being waited
Collecting after trigger	A state in which collection of the data after trigger is in progress (includes a state in which collected data is being saved in the target memory)
Collection completed	A state in which collection of a specified data is completed
Error	A state in which a memory dump error occurs and memory dump fails

21.7 Sizes of Files Used for the Memory Dump Function

This section shows the sizes of files used for the memory dump function.

Capacity of the memory dump setting file

The capacity of the memory dump setting file varies depending on the length of the save file name. The following formula is used for the calculation:

- Capacity of memory dump setting file = $((\text{Number of characters of save file name}^{*1} \times 2 \text{ bytes} + 1201 \text{ bytes (fixed)}) + 3) \div 4$
 $^{*2} \times 4$

*1 Except for the period and extension.

*2 The remainder is discarded.

Capacity of the memory dump file

The capacity of the memory dump file is given by the total of the following items:

- Capacity of memory dump file = Volume of header + Volume of data of program file name^{*1} + Volume of device data + Volume of local device data^{*1}

*1 Only when BL□\S□ (step relay with block specification) is collected.

Volume of header

The volume of header is given by:

- Volume of header = 1088 bytes (fixed)

Volume of data of program file name

Volume of data of program file name is given by the total of the following items. Only when BL□\S□ (step relay with block specification) is collected, this data is created in the memory dump file.

- Volume of data of program file name = 16 bytes (fixed) + (Number of programs \times (2 bytes (length of program file name) + 130 bytes (program file name)))

Volume of device data

The volume of device data is given by the total of the following items. Note that this data is always created in the memory dump file regardless of the settings of CPU parameters.

- Volume of device data = 520 bytes (fixed) + Volume of collected device data

■Volume of collected device data

[FX5UJ CPU module]

The volume of collected device data is 116702 bytes (fixed).

[FX5U/FX5UC CPU module]

The volume of collected device data is given by the following:

- Volume of collected device data = (Total number of points of bit devices \div 8) + (Total number of points of word devices \times 2) + (Total number of points of word devices \times 4)

Volume of local device data

The volume of local device data is given by the total of the following items. Only when BL□\S□ (step relay with block specification) is collected, this data is created in the memory dump file.



- Volume of local device data = 16 bytes (fixed) + (Number of programs \times 4 bytes) + Volume of local device contents
- Volume of local device contents = 580 bytes (fixed) + Volume of collected local device data^{*1}

*1 The total of volume which is given by calculating the number of points of S (step relay) which is assigned to each block of BL0 to BL31 of the SFC program by the following volume of block data.

Volume of block data = ((the number of points of S (step relay) which is assigned to block + 15) / 16) \times 2

21.8 Special Relay and Special Register Used in the Memory Dump Function

For details on the special relay and special register used in the memory dump function, refer to the following:

- Special relay: Special relay relating to the memory dump function ( Page 381 Memory dump function)
- Special register: Special register relating to the memory dump function ( Page 421 Memory dump function)

21.9 Precautions for the Memory Dump Function

This section describes precautions to take when using the memory dump function

Mutual exclusion of the memory dump function

The mutual exclusion of the memory dump function is as follows.

■When another function is executed

The following table lists the cases when another function is executed during the execution of the memory dump function*¹.

Function that has been already executed	Function to be executed later	Operation
Memory dump function	Data logging function	The memory dump function and data logging function cannot be used simultaneously.
	Data backup function	The data backup function cannot be executed while memory dump is being registered/cleared.
	Data restoration function	The data restoration function cannot be executed while a memory dump file or memory dump setting file is being read or memory dump is being registered/cleared.

*¹ Indicates the state in which the memory dump status is "Collecting after trigger" or the save status is "Saving in progress".

■When the memory dump function is executed during the execution of another function

The following table lists the cases when the memory dump function is executed during the execution of another function.

Function that has been already executed	Function to be executed later	Operation
Data logging function	Memory dump function	The memory dump function and data logging function cannot be used simultaneously.
Data backup function		While the data backup function is being executed, memory dump cannot be registered/cleared.
Data restoration function		While the data restoration function is being executed, a memory dump file or memory dump setting file cannot be read or memory dump cannot be registered/cleared.

■When the memory dump function is executed

The following table shows the cases where the file operation related to the memory dump function is executed while the memory dump function is in execution.*¹

Target file	File operation	Operation
Memory dump setting file	Write	Settings that are subsequently written during the execution of the memory dump function are reflected after the completion of save, not reflected immediately.
	Delete	If the memory dump setting file is subsequently deleted during the execution of the memory dump function, the memory dump settings are cleared after the completion of save.
	Initialize	Initialization fails on the memory dump setting file during the execution of the memory dump function.
Memory dump file	Write, read, delete, and initialize	Write, read, delete, and initialize on the memory dump file cannot be performed during the execution of the memory dump function.

*¹ Indicates the state in which the memory dump status is "Collecting after trigger" or the save status is "Saving in progress".

Operation on each individual file

Write, read, delete, and initialize are possible on each file. The following table shows whether each operation is possible or not depending on the execution status of memory dump.

○: Operation possible, ×: Operation not possible

File type	Operation to be performed					
	Read		Write/delete		Initialize	
	Not during execution ^{*1}	During execution ^{*1}	Not during execution ^{*1}	During execution ^{*1}	Not during execution ^{*1}	During execution ^{*1}
Memory dump setting file	○	○	○	○	○ ^{*2}	×
Memory dump file	○	×	○	×	○	×

*1 Indicates the state in which the memory dump status is "Collecting after trigger".

*2 The memory dump function is canceled when the memory dump setting file is initialized (when data memory is initialized).

Where to carry out memory dump

Concurrent execution from multiple sources is not allowed. In the CPU module, execution at a time from only one source is possible.

Creating files and folders

Under the "MEMDUMP" folder containing memory dump files, do not create any files or folders using a personal computer or other device. Doing so may result in deletion of files and folders.

Access to the SD memory card

The SD memory card is so frequently accessed that a delay occurs in completing the access to the SD memory card (read/write).

Operation when creating memory dump file

Do not turn the CPU module power OFF, reset, or eject the SD memory card while creating the memory dump file. An error such as failure to create file or failure to read created file may occur.

Simultaneous execution with the file transfer function (FTP client)

Do not transfer the file during writing with the memory dump function by the SP.FTPPUT instruction.

Event history function

If the memory dump trigger conditions are established when saving the event information in the SD memory card by generating an event with the event history function, only data collection will be executed with the memory dump function. Transfer to the SD memory card will be executed when the event history function has completed file access. In the same manner, if an event is generated with the event history function that saves during memory dump execution, the event history function data will be transferred to the SD memory card after memory dump transfer to the SD memory card is completed.

22 REAL-TIME MONITOR FUNCTION

This function monitors the contents of a specified device of the CPU module in real time with a specified interval or a desired timing. The function can be set with GX LogViewer, where the value changes of a specified device can be shown graphically. Saving the set data and displayed graphs makes it possible to simplify the settings and check the graphs at a later time. For details on the function, refer to  GX LogViewer Version 1 Operating Manual.

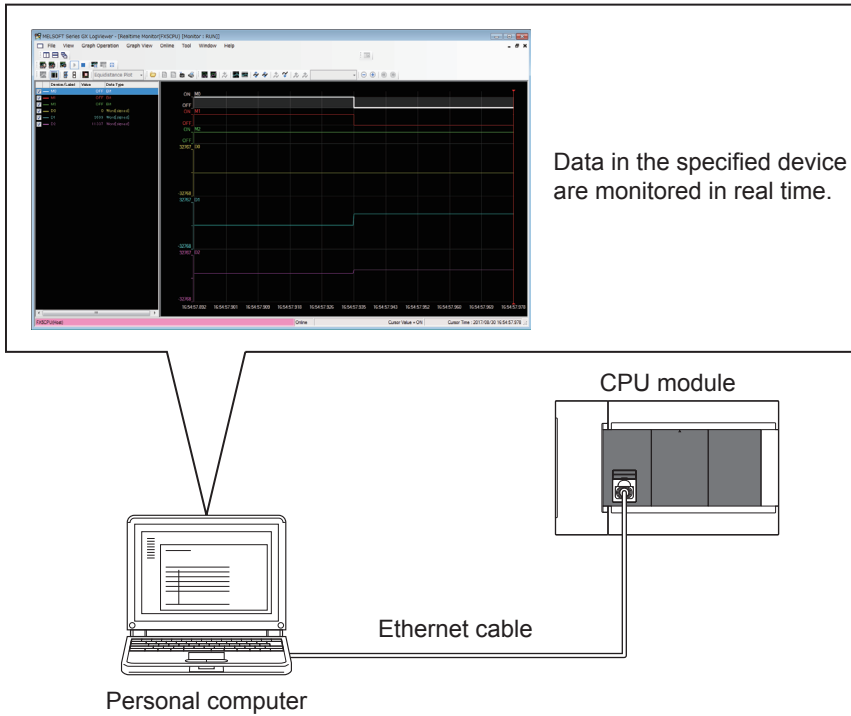

Point

For supported version of real-time monitor function, refer to  Page 566 Added and Enhanced Functions.

23 RAS FUNCTIONS

23.1 Self-Diagnostics Function

Checks if a problem exists with the CPU module.

Self-diagnostics timing

If an error occurs when the CPU module is powered on or while it is in the RUN/STOP state, the CPU module detects, and displays it, and stops operation. However, depending on the error occurrence status or the instruction to execute, the CPU module may not be able to detect the error. Configure safety circuits external to the PLC to ensure that the entire system operates safely even in such a case.

Check method of error

This section describes the check methods when error occurs.

Check method using special relay and special register

When the CPU module detects an error, it turns SM0 (Latest Self-diagnostics error (annunciator on included)) and SM1 (Latest Self-diagnostics error (annunciator on not included)) on and stores the error code corresponding to the error definition in SD0 (diagnostics error). If multiple errors are detected, the latest error code is stored in SD0. Use SM0, SM1, and SD0 on the program for the CPU module or mechanical interlock. Besides, the error code up to 16 pieces for the error contents being currently generated will be stored into SD10 (Self-diagnostics error code) to SD25 (Self-diagnostics error code). (The error code for the error content of 17th piece on and after will not be stored.)

Check method using LED

The error occurrence conditions can be checked through the lighting conditions of ERR LED. For details, refer to the following manual.

 MELSEC iQ-F FX5UJ User's Manual (Hardware)

 MELSEC iQ-F FX5U User's Manual (Hardware)

 MELSEC iQ-F FX5UC User's Manual (Hardware)

Check method using the engineering tool

The error or event history being currently generated can be checked in the Module diagnostics window. ( GX Works3 Operating Manual)

■ Existing errors

Up to 16 errors (description of errors) currently existing in the CPU module can be displayed. However, even when an additional error occurs after a stop error, the error information is not refreshed.

Point

The maximum number of displayable errors is 15 for continuation errors and 1 for stop errors. When 15 continuation errors are displayed and another one occurs, description of the new error is not displayed. Also, when an error with the same code has already been displayed, the date and time of occurrence and detailed information of the relevant error are not updated.

■ Error history

Occurred errors is logged in the event history ( Page 194 Event History Function)

The event history is updated only when a battery error occurs, independent of the operating status of the CPU module. Also, when a battery error is detected after the occurrence of an stop error, the information on existing errors is not refreshed, and only the event history is updated.

CPU Module Operation Upon Error Detection Setting

Configure each CPU Module Operation setting when an error is detected.

Error Detection Setting

Sets whether or not to detect errors.

Navigation window ⇒ [Parameter] ⇒ [FX5UJCPU] or [FX5UCPU] ⇒ [CPU Parameter] ⇒ "RAS Setting" ⇒ "Error Detections Setting"

Window

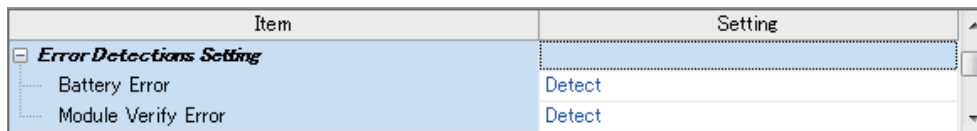

Displayed items

Item	Description	Setting range	Default
Battery Error*1	Sets whether or not to detect the battery error.	<ul style="list-style-type: none"> • Detect • Not Detected 	Detect
Module Verify Error	Sets whether or not to detect the module verification error.	<ul style="list-style-type: none"> • Detect • Not Detected 	Detect

*1 Only FX5U/FX5UC CPU module is supported.

CPU Module Operation Upon Error Detection Setting

Sets the CPU module operation upon error detection.

Navigation window ⇒ [Parameter] ⇒ [FX5UJCPU] or [FX5UCPU] ⇒ [CPU Parameter] ⇒ "RAS Setting" ⇒ "CPU Module Operation Setting at Error Detected"

Window

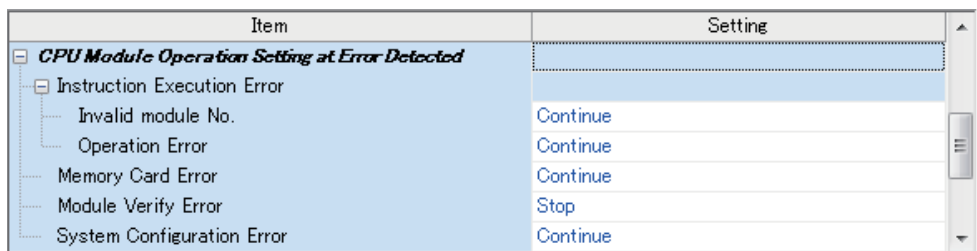

Displayed items

Item	Description	Setting range	Default
Instruction Execution Error	Invalid module No.	<ul style="list-style-type: none"> • Continue • Stop 	Continue
	Operation Error	<ul style="list-style-type: none"> • Continue • Stop 	Continue
Memory Card Error	Sets the CPU module operation upon a memory card error.	<ul style="list-style-type: none"> • Continue • Stop 	Continue
Module Verify Error	Sets the CPU module operation upon a module verification error.	<ul style="list-style-type: none"> • Continue • Stop 	Stop
System Configuration Error	Sets the CPU module operation upon a system configuration error.	<ul style="list-style-type: none"> • Continue • Stop 	Continue

LED display setting

Set whether or not to display the ERROR LED and BATTERY LED.

Navigation window ⇒ [Parameter] ⇒ [FX5UJCPU] or [FX5UCPU] ⇒ [CPU Parameter] ⇒ "RAS Setting" ⇒ "LED Display Setting"

Window

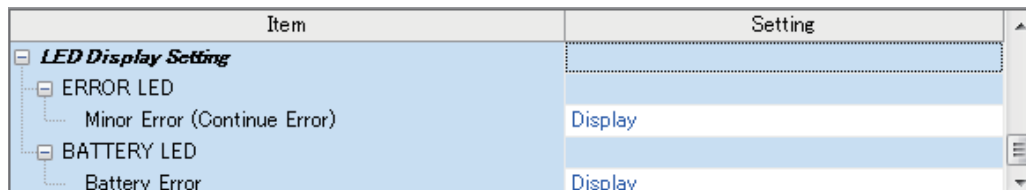

The screenshot shows a software window titled "LED Display Setting". It features a tree view on the left and a corresponding settings table on the right. The tree view is expanded to show the following items:

- LED Display Setting
 - ERROR LED
 - Minor Error (Continue Error)
 - BATTERY LED
 - Battery Error

The settings table on the right has two columns: "Item" and "Setting". The "Setting" column contains the value "Display" for both the "Minor Error (Continue Error)" and "Battery Error" items.

Displayed items

Item		Description	Setting range	Default
ERROR LED	Minor Error (Continue Error)	Sets whether or not the ERROR LED is displayed when a minor error occurs.	<ul style="list-style-type: none">• Display• Do Not Display	Display
BATTERY LED	Battery Error ^{*1}	Sets whether or not the BATTERY LED is displayed when a battery error occurs.	<ul style="list-style-type: none">• Display• Do Not Display	Display

*1 Only FX5U/FX5UC CPU module is supported.

Error Clear

This function clears all the existing continuation errors at once.

Errors that can be cleared

Error code	Error name
1080H	ROM write count error
1090H	Battery error
1120H	SNTP clock setting error
1200H	Module moderate error detected
1800H	Annunciator ON
1810H, 1811H	Operation error
1900H	Constant scan time error
1920H	IP address setting error
1921H	IP address writing/clear request simultaneous detection
1FE0 to 1FE6H, 2008H	Module configuration error
2120H, 2121H	Memory card error
2400H	Module verification error
2440H, 2441H	Module major error
2450H	Module major error detected
2522H	Invalid interrupt
2801H	Module specification error
2820H, 2821H, 2822H, 2823H	Device specification error
2840H	File name specification error
3360H to 3362H	Nesting depth error
3380H	Pointer execution error
3400H to 3406H, 3420H, 3500H, 3502H to 3506H, 350AH, 350C to 350FH, 3510H to 351EH, 3580H, 3581H, 3583H to 3588H, 3600H, 3611H to 361CH, 3621H to 362CH, 3631H to 363CH, 3641H to 364CH, 3651H to 365CH, 3661H to 366CH, 3671H to 367CH, 3681H to 368CH, 3691H to 369CH, 36A1H to 36ACH, 36B1H to 36BCH, 36F0H	Operation error
3780H	High-speed comparison table maximum excess error
3781H	Preset value range outside error

How to clear errors

Errors can be cleared in two ways:

■Using the engineering tool

Clear errors with the module diagnostics function of engineering tool. (📖GX Works3 Operating Manual)

■Using SM/SD

Clear errors by operating SM/SD.

1. Check SD0 (Latest self-diagnostics error code) to identify what errors are detected.
2. Clear the cause of each of the currently detected continuation errors.
3. Turn off and on SM50 (error reset).

Point 🔍

When clearing the error with the error code (2400H), set "Continue" to Module verification error of Operation Setting at Error Detected. (👉 Page 191 CPU Module Operation Upon Error Detection Setting) However, SM61 (I/O module verify error) which is turned ON when the error code (2400H) occurs is not turned OFF. To turn OFF SM61, the CPU module must be turned ON or reset.

Precautions

This section describes some precautions to take when using the error clear function:

- Since the function clears all of the currently detected continuation errors at once, errors that should not yet be cleared may be cleared.
- Use the RST instruction to reset each annunciator individually.

23.2 Event History Function

Information including errors detected in the CPU module, expansion board, expansion adapter and intelligent module, and errors that occur in the network is collected and saved by the CPU module. Once errors are stored, they can be checked chronologically. This function can be used to pinpoint the cause of faults that occur in the system or device.

For supported version of event history function, refer to 👉 Page 566 Added and Enhanced Functions.

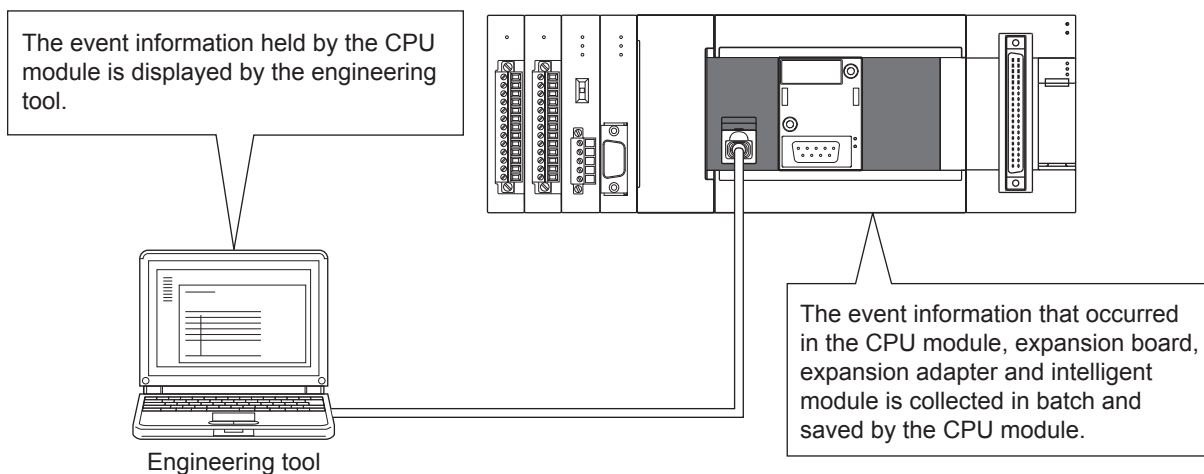

Point 🔍

The event history information is constantly collected regardless of the operating state of the CPU module. There are occasions, however, when the event history information cannot be collected due to a major error in a module, a cable failure, or some other cause.

Event history settings

Under normal circumstances, the event history function can be used with its default settings and need not be manually configured. The storage memory and size settings for event history files can be changed as needed. (📖 Page 196 Event history file)

🔍 Navigation window ⇒ [Parameter] ⇒ [FX5UJCPU] or [FX5UCPU] ⇒ [CPU Parameter] ⇒ "RAS Setting" ⇒ "Event History Setting"

Window

Item	Setting
Event History Setting	
Save Destination	Data Memory
Storage Capacity Setting per File	1.5 K Byte

Displayed items

Item	Description	Setting range	Default
Save Destination	Specify the storage location of event history files.	<ul style="list-style-type: none"> Memory Card Data Memory Built-in RAM Battery Keeping^{*1} 	Data Memory
Storage Capacity Setting per File	Specify the storage capacity per event history file.	<ul style="list-style-type: none"> 1 to 2048K bytes (Save Destination: Memory Card)^{*2} 1.5K bytes (fixed) (Save Destination: Data Memory) 1 to 64K bytes (Save Destination: Built-in RAM Battery Keeping)^{*1} Unit: 1K bytes	1.5 K Byte

*1 Only FX5U/FX5UC CPU module is supported.
 *2 FX5UJ CPU module is 2048K bytes (fixed).

Point 🔍 An optional battery is required to use the built-in RAM battery keeping. Refer to the User's Manual (Hardware) for the CPU module in use for details.

Logging of the event history

This section describes events saving for the event history.

Which event history information is collected

■Target modules

The events collected for the event history are those that occur in the CPU module and in the expansion board, expansion adapter and intelligent module connected to the CPU module.

Point 🔍 The bus access errors that occur in the CPU module when the intelligent function module is connected are also collected to the event history.

■Target networks

Collection of event history for devices on a network supports only the built-in Ethernet board communication. The communication status is a target for the event history.

Events logged by the CPU module

Information logged in the event history includes errors initiator and other detailed information for troubleshooting purposes. For events that are logged in the event history on the CPU module, refer to 📖 Page 533 Event List.

Event history file

The storage memory and file size for event history files can be changed in event history setting. ( Page 195 Event history settings)

■Storage memory

The following storage memory can be used.

- Data memory
- Built-in RAM battery keeping *1
- Memory card (SD memory card)

*1 Only FX5U/FX5UC CPU module is supported.

Point

For a system where the communication conditions are unstable and frequently change, the event history file size should be made large enough to accommodate a greater number of events.

Precautions

- If the storage memory is the built-in RAM battery keep: when the battery is not loaded or the battery voltage is low, if an operation such as power is turned OFF → ON or RESET operation is made, the generated error will not be stored into the event history.
- If the storage memory is a memory card (SD memory card), the event history will not be stored when the SD memory card's write protect switch is enabled. (The event history file in the SD memory card can be read with the engineering tool.) Thus, if the SD memory card's write protect switch is changed from disabled to enabled during operation, and an event that saves to the event history occurs, a write to SD memory card error will occur. (Immediately after the error occurs, it can be checked with the engineering tool's module diagnosis. However, the occurring error will not be saved in the event history after the power has been turned OFF and ON or the module reset, etc.)
- If the storage memory is the memory card (SD memory card): when the SD memory card is not loaded, after power is turned OFF→ ON or after resetting operation, errors will not be stored into the event history.

■File size

The size for event history files can be changed in event history setting ( Page 195 Event history settings). If the storage size exceeds the specified size, records are deleted in order from the oldest one and the latest one is stored. An event history file size is obtained from the following calculation formula.

Event history file size = File header size + Event history management information size + (Number of records × Size per event history record)

Element	Size
File header size	20 bytes
Event history management information size	12 bytes
Size per event history record*1	40 to 1112bytes (variable)

*1 Because the contents of detailed information may differ depending on the event to be saved or the detailed information may include a variable-length file name, the size per event history record is variable.

The number of events to be saved in the event history file differs depending on the event type to be saved.

■ When files are created

An event history file is created when:

- The CPU module is turned off and on (if there is no event history file or after the event history settings are changed).
- The CPU module is reset (if there is no event history file or after the event history settings are changed).
- Initialization of the SD memory card (when no event history file exists)^{*1}

*1 When a parameter is stored in the data memory, the event history file is created on the SD memory card, according to the event history setting.

The following table shows how the event history is treated depending on operation.

Operation	Operation for the event history
Memory initialization	When this event occurs, the event history is stored into the internal memory. If the internal memory reaches the maximum number of event history records it can store, all subsequent events are lost (☞ Page 197 Loss of event history information).
Event history creation	The event history, which has been stored in the internal memory during absence of the event history file, is stored into the data memory or the SD memory card (If any event was lost, it is logged as "**HST.LOSS**").

Indicates the operation of the event history for the SD memory which was removed and mounted in case that the save destination memory is the memory card (SD memory card).

Operation	Operation for the event history
Removal of the SD memory card	When this event occurs, the event history is stored into the internal memory. If the internal memory reaches the maximum number of event history records it can store, all subsequent events are lost (☞ Page 197 Loss of event history information).
Installation of the SD memory card	The event history, which have been stored in the internal memory during absence of the SD memory card, is stored to the SD memory card. If the re-inserted SD memory card contains an event history file of the same file size, the CPU module continues to store the event history information. If the file size is different, the CPU module removes the existing event history file and creates a new event history file.

■ When parameters take effect

Any changed parameters take effect when:

- The CPU module is powered on
- The CPU module is reset

Point

Any changed parameters written in the storage memory with the CPU module in the STOP state does not take effect when the CPU module operating state is changed from STOP to RUN. In this case, the changed parameters will take effect the next time when the CPU module is turned off and on or reset.

Loss of event history information

If events are detected frequently, some events may be lost without being collected. When event loss occurs, "**HST.LOSS**" appears in the "Event Code" field of the engineering tool.

Viewing the event history

The event history can be viewed using the menus of the engineering tool. For operating procedures and how to interpret the displayed information, refer to the following:

 GX Works3 Operating Manual

Clearing the event history

The event history can be cleared using the event history window. Once the event history is cleared, the CPU module deletes all the event history information stored in the specified storage memory. For operating procedures and other details, refer to the following:

 GX Works3 Operating Manual

Precautions

Clearing the event history during execution of another function

The event history cannot be cleared while executing the backup/restoration function. ( Page 199 DATA BACKUP/RESTORATION FUNCTION) Confirm that the backup/restoration function is not being executed before executing event history clear.

Reading the event history during execution of another function

The event history cannot be read out while executing the restoration function. ( Page 210 Restoration Function) Confirm that the restoration function is not being executed before reading the event history.

24 DATA BACKUP/RESTORATION FUNCTION

This function backs up the data memory and device/label data*¹ of a CPU module to an SD memory card. The data backed up in the SD memory card can be restored as required.

*1 Module access devices and buffer memory are excluded.

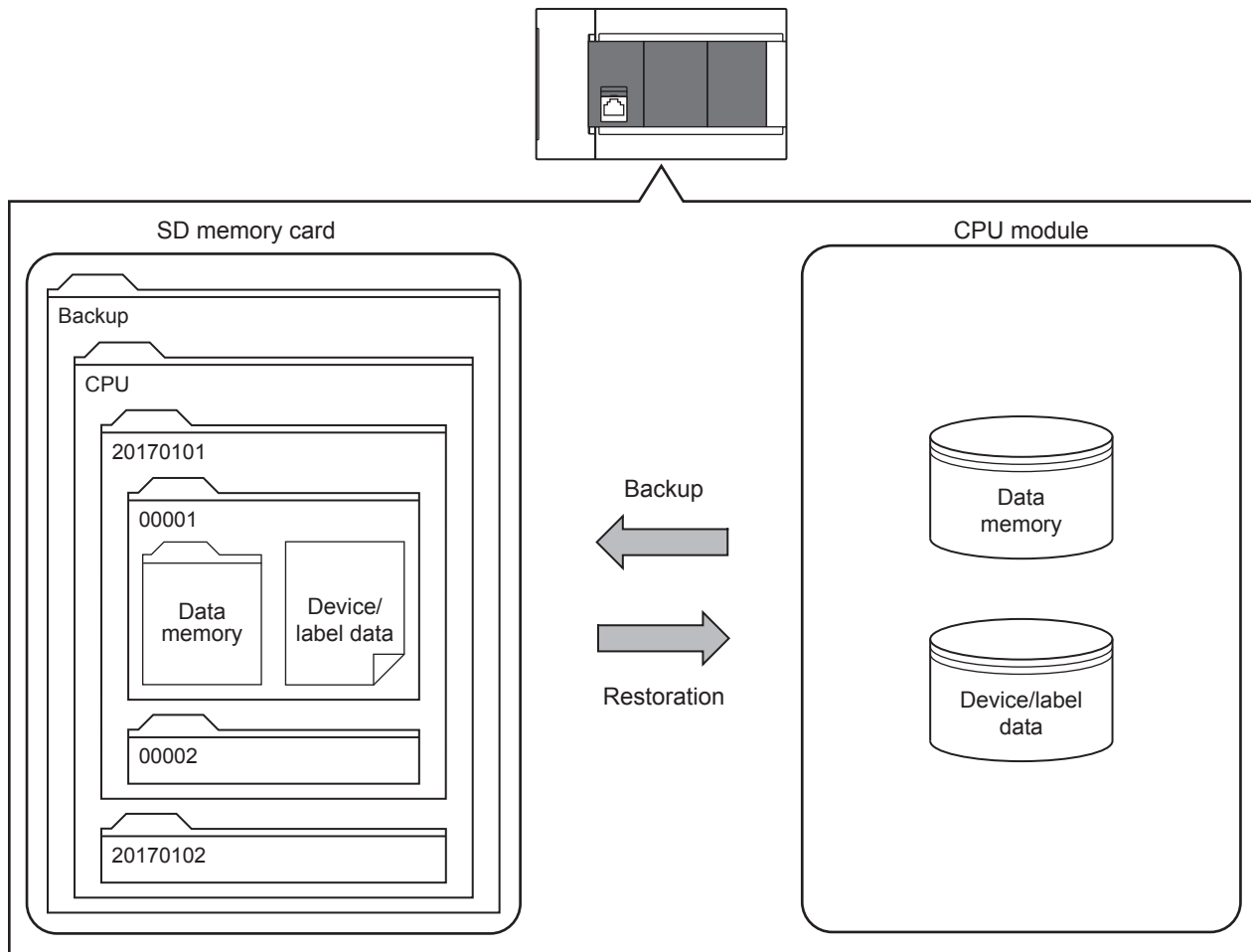

The following table lists the methods of the data backup/restoration.

Function		Reference
Backup function	Backup processing triggered by turning on SM1351 (Normal Mode)	Page 205
	Backup processing triggered by turning on SM1351 (CPU module auto exchange function)	Page 206
Restoration function	Restoration processing triggered by turning on SM1354	Page 212
	Automatic restoration using SD955	Page 213
	Restoration triggered by CPU module auto exchange	Page 214

Point

- For supported version of FX5U/FX5UC CPU module data backup/restoration function, refer to Page 566 Added and Enhanced Functions.
- The CPU module device/label data is changed when restoration is executed. Thus, after restoration, confirm the restored data carefully before using it. (Check the data with GX Works3.)

Backup data

Backup data is saved in an SD memory card. The following shows the folder structure of backup data.

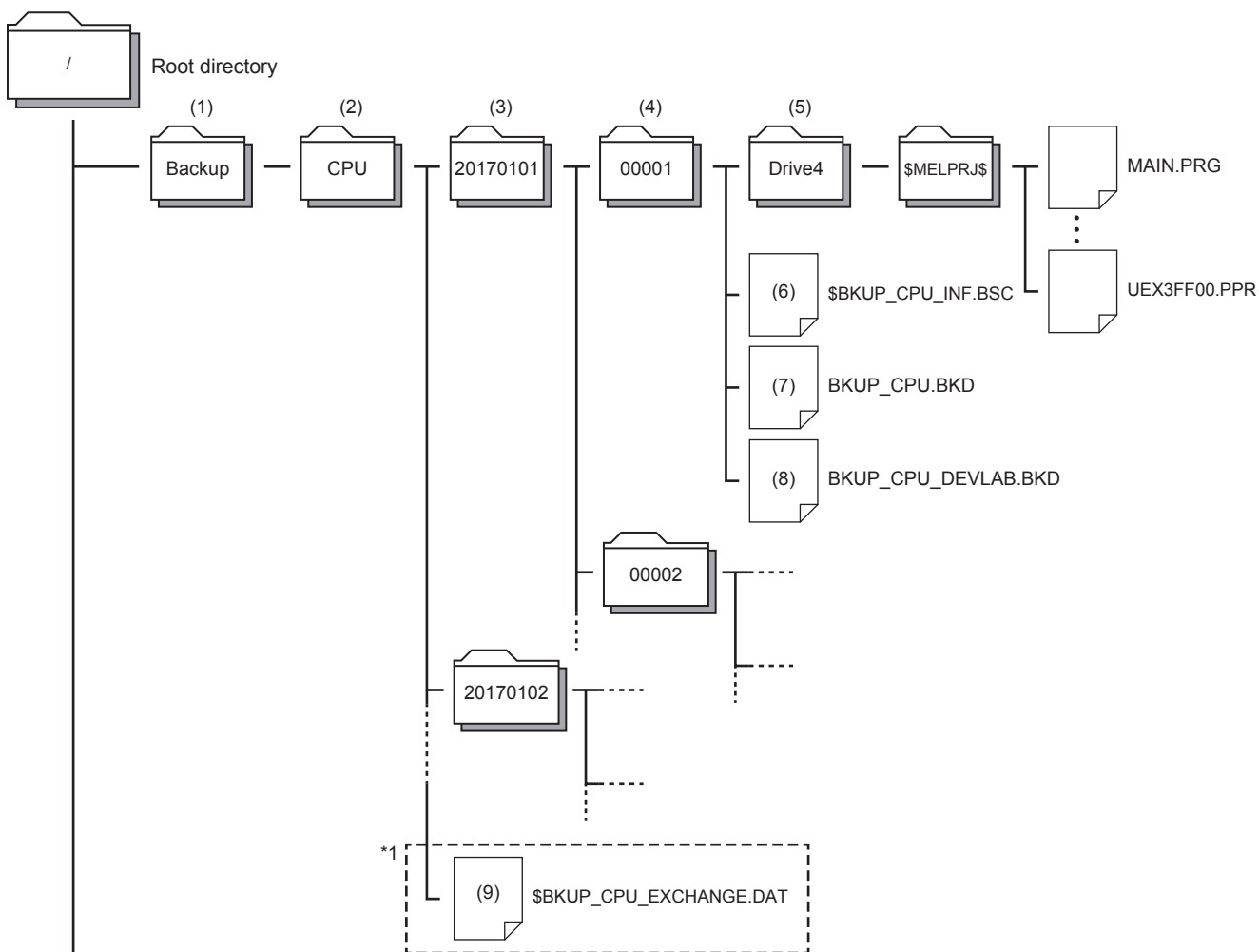

*1 When backing up by CPU module auto exchange mode (Deleting existing data), if the system file for CPU module auto exchange function is stored in the CPU data folder, only the latest folder will exist for the date folder and number folder.

Folder

No.	Folder type	Folder name	Number of storable folders	Description
(1)	Backup data folder	Backup (Fixed)	1	A folder for storing all backup data
(2)	CPU data folder	CPU (Fixed)	1	A folder for storing backup data of the CPU module
(3)	Date folder	Automatically determined* ¹ Folder name format: YYYYMMDD • YYYY: Year when the data was backed up (four digits) • MM: Month when the data was backed up (two digits) • DD: Day when the data was backed up (two digits)	Depends on the capacity of the SD memory card used* ²	Folders for storing backup data by date
(4)	Number folder	Automatically determined* ¹ Folder name: Sequentially numbered from 00001 to 32767 (five digits)	Depends on the capacity of the SD memory card used* ²	Folders for storing information per backup data. Each backup data created on a date is stored in sequentially numbered folders.
(5)	Drive folder	Drive4 (Fixed)	One in each Number folder	Folders for storing folders/files stored in each drive of the backup target CPU module, separated by drive

*1 Date folders and number folders are automatically named by the CPU module.

*2 The maximum number of storable folders is 32767. However, when backing up with the CPU module auto exchange mode (Deleting existing data), the folders other than the latest folder will be deleted.

■ Back up file

No.	File type	File name	Description
(6)	System file for backing up CPU module data	\$BKUP_CPU_INF.BSC	Files for storing the information required at restoration of data, such as a list of backup data and identification information of the CPU module.
(7)	Backup data file for backing up CPU module data	BKUP_CPU.BKD	The following data is stored. <ul style="list-style-type: none"> • Data on operations of the data logging setting • Data for restarting the SFC program from the block and step where the processing was stopped
(8)	Device/label data file for backing up CPU module data	BKUP_CPU_DEVLAB.BKD	Device/label data is stored.
(9)	System file for CPU module auto exchange function	\$BKUP_CPU_EXCHANGE.DAT	Information required for restoration with the CPU module auto exchange, such as restoration target directory path name, etc., is stored.

Backup/restoration target data

Backup target data is all target data in the CPU module. (☞ Page 201 Backup/restoration target files)

Restoration target data is set with SD954 (Restoration target data setting). (☞ Page 210 Restoration target data)

■ Backup/restoration target drives

Target drives is Drive4 (Data memory).

■ Backup/restoration target files

The following table lists backup/restoration target files.

○: Available, ×: Not available

File type	Backup/restoration
Program	○
FB files	○
CPU parameters	○
System parameters	○
Module parameters	○
Module extension parameter	○
Memory card parameter	×
Device comments	○
Device initial values	○
Event history	○
Global label settings	○
Device data storage file	○
Data logging setting file	○
Memory dump setting file	○
Remote password	○
Firmware update	×
Firmware update prohibited	○
Extended file register file	×
Slave station parameter file*1	○
Web server binary file	×
General-purpose data	×

*1 Applicable only to FX5U/FX5UC CPU module.

■ The number of CPU module backup data that can be stored in an SD memory card

The number of CPU module backup data that can be stored in an SD memory card is 32767.

The number of files that can be backed up and restored (the number of backup source data files) depends on the maximum number of files of the drive. (☞ Page 41 CPU MODULE MEMORY CONFIGURATION)

■Backup/restoration target device data

○: Available, ×: Not available

Classification	Device name	Symbol	Backup/restoration possibility ^{*1}	
			Backup	Restoration
User device	Input	X	○	○
	Output	Y	×	×
	Internal relay	M	○	○
	Latch relay	L	○	○
	Link relay	B	○	○
	Annunciator	F	○	○
	Link special relay	SB	○	○
	Step relay	S	○	○
	Timer	T	○	○
	Retentive timer	ST	○	○
	Counter	C	○	○
	Long counter	LC	○	○
	Data register	D	○	○
	Link register	W	○	○
	Link special register	SW	○	○
System device	Special relay	SM	○	○ ^{*2}
	Special register	SD	○	○ ^{*2}
Module access device (U□\G□)	Module access device	G	×	×
Index register	Index register	Z	○	○
	Long index register	LZ	○	○
File register	File register	R	○	○
	Extended file register	ER	×	×
Nesting	Nesting	N	×	×
Pointer	Pointer	P	×	×
	Interrupt pointer	I	×	×
SFC ^{*3}	SFC block device	BL	×	×
	SFC transition device	TR	×	×
Constant	Decimal constant	K	×	×
	Hexadecimal constant	H	×	×
	Real constant	E	×	×
	Character string constant	—	×	×

*1 Device data may be overwritten depending on the mounting status (I/O refresh) of each module or the refresh settings.

*2 Values may be overwritten to the areas used by the system after the restoration processing.

Restoring or not restoring can be selected with either of SD955 (restoration function setting) or SD9352 (CPU module auto exchange function setting).

*3 Only FX5U/FX5UC CPU module is supported.

■Backup/restoration target label data

○: Available, ×: Not available

Classification	Backup/restoration possibility ^{*1}	
	Backup	Restoration
Global label (including module labels)	○	○ ^{*2}
Global label with latch specified	○	○
Local label	○	○
Local label with latch specified	○	○

*1 Device data may be overwritten depending on the mounting status (I/O refresh) of each module or the refresh settings.

*2 For module labels, the write areas from a module to the CPU module may be overwritten when the refresh settings have been made.

Progress of the backup/restoration processing

The progress of the backup/restoration processing can be checked with SD1350 (Number of uncompleted folders/files of CPU module data backup/restoration) or SD1351 (Progression status of CPU module data backup/restoration).

Special register	Description
SD1350	Displays the number of remaining backup/restoration target folders and files. <ul style="list-style-type: none">• When the backup/restoration processing is started, the total number of backup/restoration folders and files is stored.• When the backup/restoration processing is completed, 0 is stored.
SD1351	Displays the progress of the backup/restoration processing in percentage (0 to 100%). However, the progress of automatic restoration using SD955 and restoration with CPU module auto exchange are displayed only when the restoration finishes correctly (100%).

24.1 Backup Function

This function backs up the CPU module data memory and device/label data onto the SD memory card. A new folder is created during the backup, and the data is backed up with a file format into that folder.

Point

The backup function operates even when the CPU module is in the RUN state.

When executing the backup function with the CPU module in the RUN state, do not change device/label data during execution of the function. Doing so may cause data inconsistency of the device/label data and the contents of the backup data may unintentionally change.

Operation Mode

Backup modes include the normal mode and CPU module auto exchange mode. The operation mode is set with SD9350 (Operation mode setting).

Value of SD9350	Operation Mode	Reference
0	Normal Mode	Page 205
1	CPU module auto exchange function (Deleting existing data)	Page 206
2	CPU module auto exchange function (Holding existing data)	

Restoration target data setting

When backing up (CPU module auto exchange mode) by turning SM1351 ON, the data targeted for restoration with CPU module auto exchange is set. Set with SD9351 (CPU module automatic replacement function Restore target data setting).

Value of SD9351	Restoration target data setting
0	Only device/label data
1	All target data
2	All target data excluding device/label data

The settings are reflected onto the system file for CPU module auto exchange function.

Restoration of the special relay and special register

Set whether or not to restore the special relays and special registers with the CPU module auto exchange when backing up with SM1351 ON (CPU module auto exchange mode). Set with SD9352 (CPU module auto exchange function setting) b14 (special relay, special register restoration (CPU module auto exchange function)).

b14 of SD9352	Restoration target data setting
OFF	The special relay and special register are not restored.
ON	The special relay and special register are restored.

The settings are reflected onto the system file for CPU module auto exchange function.

Initializing target data

When backing up with SM1351 ON (CPU module auto exchange mode), set whether or not to initialize the drive other than the SD memory card at the time of restoration by the CPU module auto exchange. Set with SD9352 (CPU module auto exchange function setting) b1 (initialize during CPU module auto exchange function).

This setting is valid only when the SD9351 (CPU module automatic replacement function Restore target data setting) value is 1 (restoration target data is all target data).

b1 of SD9352	Restoration target data setting
OFF	Do not initialize.
ON	Initialize.

The settings are reflected onto the system file for CPU module auto exchange function.

Setting of operation after restoration

When using backup processing triggered by turning on SM1351 (CPU module auto exchange mode), after restoration is executed with CPU module auto exchange, the CPU module operation can be continued from the backed up state or from the initialized state. This can be set with SD9352 (CPU module auto exchange function setting) b15 (setting of operation after CPU module auto exchange function). The operation of each item using the operation setting after restoration is shown below.

Item	Setting of operation after restoration by CPU module auto exchange	
	Continue operation from backed up state (b15 of SD9352 = ON)	Operate from initialized state (b15 of SD9352 = OFF)
Initial device value	Do not set device initial values after restoration.	Set device initial values after restoration. (Device data from backed up state is overwritten with device initial values.)
SFC program	When "Resume Start" was selected before data backup, the SFC program is resumed after restoration processing.*1	The SFC program is not resumed after restoration processing even though "Resume Start" was selected before data restoration.
Event history	Set event history during backup.	Do not set backup event history, and create new file.

*1 When a battery is not mounted, the start of the SFC program is initial start regardless of setting of operation after restoration.

The settings are reflected onto the system file for CPU module auto exchange function.

Note that this setting is invalid since the device initial value file, SFC program, and event history file are not restored when the value in SD9351 (CPU module automatic replacement function Restore target data setting) is 0 (restoration target data are only device/label data).

Backup processing triggered by turning on SM1351 (Normal Mode)

Data in the CPU module is backed up at a desired timing. Each time backup is requested, the year, date and serial No. of the date folder and number folder are updated (newly created), and the following backup data is created.

- System file for backing up CPU module data
- Backup data file for backing up CPU module data
- Device/label data file for backing up CPU module data

Operating procedure

1. Set 0 (Normal mode) for SD9350 (Operation mode setting).
2. Turn on SM1351 (Data backup execution request).

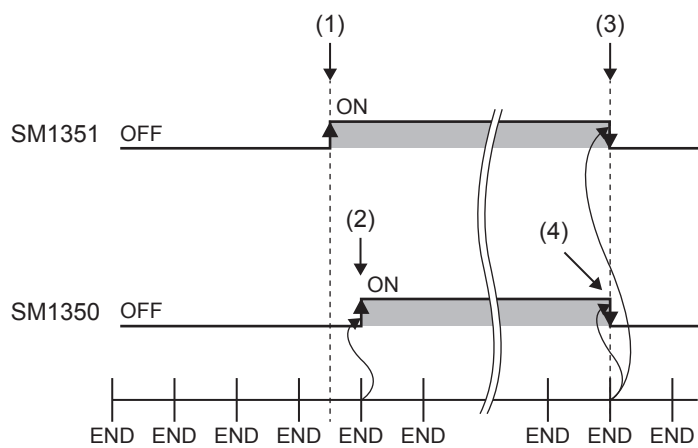

- (1) Turn on SM1351.
- (2) The system turns on SM1350 (Data backup status flag).
- (3) The system turns off SM1351 after the backup processing is completed.
- (4) The system turns off SM1350.

If the backup processing is completed with an error and SM953 (Data backup error check flag) turns on, check SD953 (Backup error cause), take actions, and then back up the data again as required.

Point

- The execution status of the backup processing can be checked with SD1350 (Number of uncompleted folders/files of CPU module data backup/restoration) and SD1351 (Progression status of CPU module data backup/restoration). (Page 203 Progress of the backup/restoration processing)
- If the system file for the CPU module auto exchange function is stored in the CPU data folder, the system file for the CPU module auto exchange function will be deleted when the backup execution request (SM1351) changes from OFF to ON.

Backup processing triggered by turning on SM1351 (CPU module auto exchange function)

Data in the CPU module is backed up at a desired timing. The operation during back up differs according to the SD9350 (operation mode setting) value.

■ CPU module auto exchange mode (Deleting existing data)

When the SD9350 value is 1, each time the backup is requested, all of the data under the CPU data folder in the SD memory card is deleted, and a date folder, number folder, and the backup data are created. (Only the latest backup file is stored on the SD memory card.)

■ CPU module auto exchange mode (Holding existing data)

When the SD9350 value is 2, each time the backup is requested, the year, date, and serial No. of the date folder and number folder are updated (newly created), and the backup data is created. (Multiple backup folders are stored on the SD memory card.)

The backup files created during the backup processing triggered by turning on SM1351 (CPU module auto exchange mode) are shown below.

- System file for backing up CPU module data
- Backup data file for backing up CPU module data
- Device/label data file for backing up CPU module data
- System file for CPU module auto exchange function

Operating procedure

1. SM9350 (CPU module auto exchange function enable/disable flag) is turned OFF (enable).
2. Set SD9350 (Operation mode setting) to 1 or 2*¹.
3. With SD9351 (CPU module automatic replacement function Restore target data setting), set the data to be restored when executing restoration with CPU module auto exchange.*²
4. Make each setting with SD9352 (CPU module auto exchange function setting) b1*², 14, and 15*².
5. Turn on SM1351 (Data backup execution request).

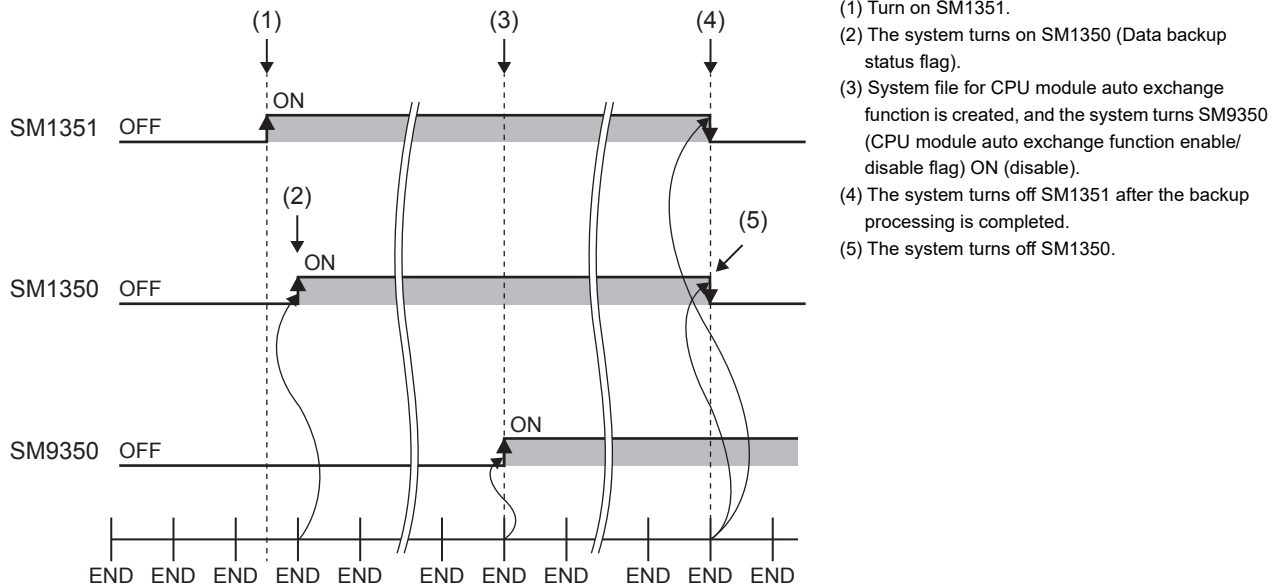

*¹ Only 1 (CPU module auto exchange mode (delete existing data)) is valid with firmware version of FX5U/FX5UC CPU module earlier than "1.050".

*² This operation is required when the FX5UJ CPU module and later and firmware version of FX5U/FX5UC CPU module is "1.050" and later.

If the backup processing is completed with an error and SM953 (Data backup error check flag) turns on, check SD953 (Backup error cause), take actions, and then back up the data again as required.

Point

The execution status of the backup processing can be checked with SD1350 (Number of uncompleted folders/files of CPU module data backup/restoration) and SD1351 (Progression status of CPU module data backup/restoration). (Page 203 Progress of the backup/restoration processing)

Checking backup errors

When an error has occurred, a diagnostic error is not detected and an error code is stored in SD953 (Backup error cause). (Page 473 List of error codes)

Precautions

The following describes the precautions for the backup function.

Prohibited operation during execution of the backup processing

Do not perform the following operations during execution of the backup processing.

- Attaching or detaching the SD memory card
- Powering off or resetting the CPU module

The above mentioned operations leave the backup data in the SD memory card in an incomplete state which is in the middle of the backup processing. Do not use these data for a restoration. If these data are used, the restoration completes with an error.

Suspending backup processing

The following operation can suspend a backup processing.

- Setting the SD memory card forced disable

Suspending a backup processing leaves the backup data in the SD memory card in an incomplete state which is in the middle of the backup processing. Do not use these data for a restoration. If these data are used, the restoration completes with an error.

Device/label data

To execute the backup processing, do not change device/label data during execution of the processing. Since device/label data is divided into multiple scans and backed up, changes in the device/label data may cause data inconsistency.

Operations and functions that cannot be performed

While the following operations or functions are being executed, the backup processing cannot be executed.

The following operations and functions cannot be executed during execution of the backup processing.

Operation or function		
Operation from GX Works3	Initializing the CPU built-in memory/SD memory card	
	Clearing values (Devices, labels, latches)	
	Reading data from the PLC	
	Writing data to the PLC	
	Verifying data with the PLC	
	Deleting data in the PLC	
	Online change	
	Event history function (Updating event history data, clearing event history)	
	File password function	
	Security key authentication function (Writing/deleting a security key to/in the CPU module)	
	Predefined protocol support function (Writing/reading/verifying protocol setting data)	
	Memory dump function (Memory dump setting/reading results, registering/clearing memory dump)	
Operation using the CPU Module Logging Configuration Tool	Data logging function (Writing/reading/deleting a logging setting file, registering/clearing a logging setting)	
	Operation of a logging file (deletion)	
Others	Initial device values (Stopping and running the CPU module)	
	<ul style="list-style-type: none"> • SLMP • MC protocol 	Remote latch clear
	Ethernet communication	File transfer function (FTP server)
		File transfer function (FTP client)

Special relay and special register that function as flags to execute other functions

Before executing the backup processing, turn off the special relay and special register that function as flags to execute other functions. If the backup processing is executed when they are on, the corresponding function request may turn on and the function may be executed at the restoration of data in the special relay and special register.

SFC program status

Do not change the status of the SFC program, such as step active status and transition conditions during execution of the backup processing. If the status of the SFC program was changed, the backup processing is completed with an error.

Time required for completing the backup processing

It may take time for the backup to finish in the following cases:

- When the size of data or number of folders/files stored on the CPU module is large
- When a function that accesses the SD memory card, such as data logging function or event history function (save destination: SD memory card), is operating
- When Ethernet communication is in progress

If the backup does not finish, format the SD memory card, or re-insert the memory card. If the backup still does not finish, the SD memory card may have a hardware error, so replace the SD memory card.

Precautions

The scan time increases during backup.

Backup when changing the parameters

If the CPU module parameters have been changed, turn the CPU module power OFF and ON or reset the CPU module to apply the parameters. Then execute backup. If backup is executed before the parameter changes are applied, restoration may not be carried out correctly.

Random folder/file

Do not create a random folder/file in the CPU data folder. The backup will not function correctly in the CPU module auto exchange mode.

24.2 Restoration Function

This function restores backup data in the SD memory card to the CPU module.

Restoration target folder

Set restoration target data among backup data in the SD memory card with SD956 (Restoration target date folder setting) to SD958 (Restoration target number folder setting). The latest backup data can be restored with b13 (Restoration target folder) of SD955 (Restoration function setting).

Special register	Description
b13 of SD955	Set the restoration function setting with bit patterns. <ul style="list-style-type: none">• OFF: Data specified with the restoration target folders is restored.• ON: The latest data is restored.*1
SD957, SD956	Specify the date folder of the restoration target data in BCD. SD957: Year, SD956: Month and date
SD958	Specify the folder number (00001 to 32767) of restoration target data.

*1 The latest data is the backup data with the largest number in the newest date folder.

Restoration target data

Restoration target data is set with SD954 (Restoration target data setting).

Value of SD954	Restoration target data setting
0	All target data
1	Only device/label data
2	All target data excluding device/label data

Note that this function is invalid when restoring with CPU module auto exchange.

Restoration of the special relay and special register

The setting for whether or not to restore the special relays and special registers differs according to the restoration function being executed.

■For restoration triggered by turning SM1354 ON, and automatic restoration using SD955

Set with SD955 (restoration function setting) b14 (special relay, special register restoration).

b14 of SD955	Restoration target data setting
OFF	The special relay and special register are not restored.
ON	The special relay and special register are restored.

■Restoration by CPU module auto exchange

The special relay and special register are restored based on the system file for CPU module auto exchange function, so a setting is not required. (☞ Page 203 Restoration of the special relay and special register)

■Special relays and special registers that are not restored

Even when restoration is executed, the following special relays and special registers are not restored.

- SM953 (Data backup error check flag)
- SM959 (Data restoration error check flag)
- SM1350 (Data backup status flag)
- SM1351 (Data backup execution request)
- SM1353 (Data restoration status flag)
- SM1354 (Data restoration execution request)
- SM8492 (IP address storage area write request)
- SM8495 (IP address storage area clear request)
- SD953 (Backup error cause)
- SD959 (Restoration error cause)
- SD1350 (Number of uncompleted folders/files of CPU module data backup/restoration)
- SD1351 (Progression status of CPU module data backup/restoration)

Initialization during automatic restoration.

When executing automatic restoration with SD955, set whether or not to initialize the drives other than the SD memory card with SD955 (restoration function setting) b1 (initialize during automatic restoration). This function is valid only when SD954 (restoration target data setting) is 0 (all target data).

b1 of SD955	Restoration target data setting
OFF	Do not initialize.
ON	Initialize.

Setting of operation after restoration

Set whether after restoration the CPU module operation is to continue from the backup state or from the initialized state with SD955 (restoration function setting) b15 (setting of operation after restoration).

Item	Setting of operation after restoration	
	Continue operation from backed up state (b15 of SD955 = ON)	Operate from initialized state (b15 of SD955 = OFF)
Initial device value	Do not set device initial values after restoration.	Set device initial values after restoration. (Device data from backed up state is overwritten with device initial values.)
SFC program	When "Resume Start" was selected before data backup, the SFC program is resumed after restoration processing.*1	The SFC program is not resumed after restoration processing even though "Resume Start" was selected before data restoration.
Event history	Set event history during backup.	Do not set backup event history, and create new file.

*1 When a battery is not mounted, the start of the SFC program is initial start regardless of setting of operation after restoration. Note that this setting is invalid since the device initial value file, SFC program, and event history file are not restored when the value in SD954 (Restoration target data setting) is 1 (restoration target data are only device/label data). Also, this setting is invalid by restoration with CPU module auto exchange.

Restoration processing triggered by turning on SM1354

Backup data is restored at a desired timing. When restoration is requested, the CPU module backup data based on the following files in the designated folders are restored.

- System file for backing up CPU module data
- Backup data file for backing up CPU module data
- Device/label data file for backing up CPU module data

Point 

Restoration, triggered by turning on SM1354, should be used to check the backup data or to check the operation before running the main one. To start main working operation of the system with the backup data, use automatic restoration using SD955 or restoration with CPU module auto exchange.

Restriction 

The restoration processing triggered by turning on SM1354 (Data restoration execution request) can be executed only when the CPU module is the STOP state.

Operating procedure

1. Set restoration target data with SD954 (restoration target data setting).^{*1}
2. Set restoration target folders with SD956 (Restoration target date folder setting) to SD958 (Restoration target number folder setting). (However, this is not required when SD955 (restoration function setting) b13 (restoration target folder) is turned ON in step 3.)
3. Set each setting with the b13 to 15^{*2} of SD955.
4. Set the CPU module to the STOP state.
5. Turn on SM1354 (Data restoration execution request).

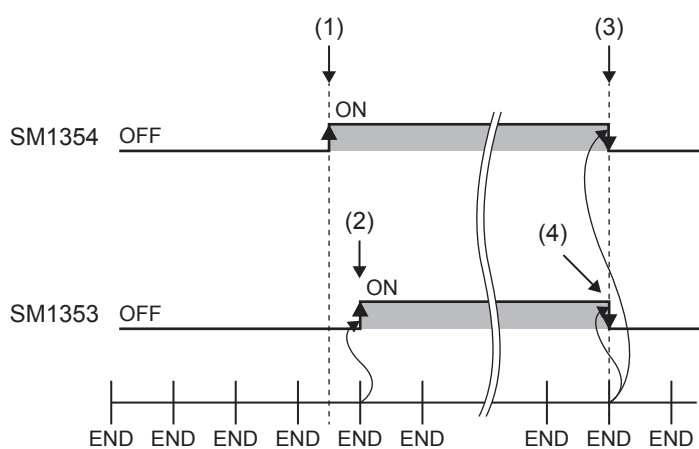

- (1) Turn on SM1354.
- (2) The system turns on SM1353 (Data restoration status flag).
- (3) The system turns off SM1354 after the restoration processing is completed.
- (4) The system turns off SM1353.

*1 Only 1 (only device/label data) is valid with firmware version of FX5U/FX5UC CPU module earlier than "1.050".

*2 The b15 (operation after restoration setting) is required when the FX5UJ CPU module and later and firmware version of FX5U/FX5UC CPU module is "1.050" and later.

If the restoration processing is completed with an error and SM959 (Data restoration error check flag) turns on, check SD959 (Restoration error cause), take actions, and then restore the data again as required.

Point 

The execution status of the restoration processing can be checked with SD1350 (Number of uncompleted folders/files of CPU module data backup/restoration) and SD1351 (Progression status of CPU module data backup/restoration). ( Page 203 Progress of the backup/restoration processing)

Automatic restoration using SD955

Backup data is automatically restored when the CPU module is powered on or is reset. When restoration is executed, the CPU module backup data based on the following files in the designated folders are restored.

- System file for backing up CPU module data
- Backup data file for backing up CPU module data
- Device/label data file for backing up CPU module data

Operating procedure

1. Set restoration target data with SD954 (restoration target data setting).^{*1}
2. Set restoration target folders with SD956 (Restoration target date folder setting) to SD958 (Restoration target number folder setting). (However, this is not required when SD955 (restoration function setting) b13 (restoration target folder) is turned ON in step 3.)
3. Set each setting with the b1, b13 to 15^{*2} of SD955.
4. Turn on the b0 (Auto restoration request) of SD955.
5. Power on or reset the CPU module.

*1 Only 1 (only device/label data) is valid with firmware version of FX5U/FX5UC CPU module earlier than "1.050".

*2 The b1 (initialization during automatic restoration) and b15 (operation after restoration setting) settings are required when the firmware version of FX5U/FX5UC CPU module is "1.050" and later.

If the restoration processing is completed with an error and SM959 (Data restoration error check flag) turns on, check SD959 (Restoration error cause), take actions, and then restore the data again as required.

Point

- Since the special register set for the automatic restoration is a latch area, setting data is held.
- SD955 (Restoration function setting) holds its setting even after the CPU module is powered on or is reset. Thus, if the CPU module is powered on or is reset while the b0 (Auto restoration request) of SD955 is on, the automatic restoration is executed again. To not perform the automatic restoration when the CPU module is powered on or is reset the next time, turn off b0 of SD955 after a restoration is completed and then power on or reset the CPU module.

Restoration triggered by CPU module auto exchange

At power ON or at reset, the backup data is automatically reset without the need for a command. When restoration is executed, the CPU module backup data is restored based on the system file for the CPU module auto exchange function in the SD memory card.

Restriction

The CPU module auto exchange is executed only when the system file for the CPU module auto exchange function created with backup during the CPU module auto exchange mode is stored on the SD memory card.

Operating procedure

1. Insert the SD memory card containing the system file for CPU module auto exchange function created with backup during the CPU module auto exchange mode into the CPU module.
2. SM9350 (CPU module auto exchange function enable/disable flag) is turned OFF (enable). (For CPU module backed up with the CPU module auto exchange mode, or CPU module restored with CPU module auto exchange)
3. Power on or reset the CPU module.



When the restoration finishes correctly, the system turns SM9350 (CPU module auto exchange function enable/disable flag) ON (disable).

If the restoration processing is completed with an error and SM959 (Data restoration error check flag) turns on, check SD959 (Restoration error cause), take actions, and then restore the data again as required.

Point

- SM9350 (CPU module auto exchange function enable/disable flag) turns ON (enable) each time restoration is executed with CPU module auto exchange, so unless SM9350 is turned OFF (enable) specifically, restoration with CPU module auto exchange will not be executed each time the power is turned OFF and ON or reset.
- The CPU module target data is restored based on the system file for CPU module auto exchange function so the SD955 (restore function setting) setting is disabled.

Checking restoration errors

- When an error occurs in the restoration processing triggered by turning on SM1354, a diagnostic error is not detected and an error code is stored in SD959 (Restoration error cause). ( Page 473 List of error codes)
- A diagnosis error will be detected if an error occurs during restoration with the SD955 automatic restoration and CPU module auto exchange. An error code is also stored in SD959. ( Page 473 List of error codes)

Precautions

The following describes the precautions for the restoration function.

Prohibited operation during execution of the restoration processing

Do not perform the following operations during execution of the restoration processing.

- Attaching or detaching the SD memory card
- Powering off or resetting the CPU module

The above mentioned operations leave the data in the CPU module in an incomplete state which is in the middle of the restoration processing. Do not run the CPU module with this incomplete state. Doing so may cause an unintended operation. Execute restoration again, or write the data to the CPU module after initialization of the CPU module.

Suspending the restoration processing

The following operation can suspend a restoration processing.

- Setting the SD memory card forced disable

Suspension during a restoration leaves the data in the CPU module in an incomplete state which is in the middle of the restoration processing. Do not run the CPU module with this incomplete state. Doing so may cause an unintended operation. Execute restoration again, or write the data to the CPU module after initialization of the CPU module.



Automatic restoration using SD955 and restoration using CPU module auto exchange cannot be suspended.

Types of CPU modules that execute restoration

Make sure CPU module model being restored is the same model as the backup source CPU module. Restoration of different models is not possible.

When error is occurring in CPU module

Restoration may not be possible if a parameter error is occurring in the CPU module at the restoration destination.

Changing the operating status during execution of restoration

During execution of the restoration processing, the CPU module remains in the STOP state even if the RUN/STOP/RESET switch is changed from the STOP to RUN position or the remote RUN or the remote PAUSE is executed. The following operation will take place if the CPU module operation status is changed while executing restoration.

- If the restoration target data is all target data or all target data excluding device/label data, the specified operation status will not be entered when restoration is completed.
- If performing restoration without parameter change (parameter of backup date and restoration destination CPU module are same), the specified operation status will be entered.
- The specified operation status is entered after restoration is completed only when the restoration target data is device/label data.
- If performing automatic restoration or restoration with CPU module auto exchange, the specified operation status will be entered when restoration is completed.



Operations and functions that cannot be performed

While the following operations or functions are being executed, the restoration processing cannot be executed. The following operations and functions cannot be executed during execution of the restoration processing.

Operation or function		
Operation from GX Works3	Initializing the CPU built-in memory/SD memory card	
	Clearing values (Devices, extended file registers, labels, latches)	
	Reading data from the PLC	
	Writing data to the PLC	
	Verifying data with the PLC	
	Deleting data in the PLC	
	Online change	
	Event history function (Updating event history data, clearing event history)	
	File password function	
	Security key authentication function (Writing/deleting a security key to/in the CPU module)	
	Predefined protocol support function (writing/reading/verifying protocol setting data)	
	Memory dump function (Memory dump setting/reading results, registering/clearing memory dump)	
Operation using the CPU module logging configuration tool	Data logging function (Writing/reading/deleting a logging setting file, registering/clearing a logging setting)	
	Operation of a logging file (deletion)	
Others	<ul style="list-style-type: none"> • SLMP • MC protocol 	Remote latch clear
	Ethernet communication	File transfer function (FTP server)
		File transfer function (FTP client)

Functions that cannot be executed simultaneously with automatic restoration or CPU module auto exchange

Do not execute automatic restoration using SD955, or restoration by automatic restoration using SD955 and CPU module auto exchange simultaneously with the following functions.

- Firmware update function ( Page 53 FIRMWARE UPDATE FUNCTION)
- Boot operation ( Page 139 Boot Operation)

If these are executed simultaneously, automatic restoration or restoration with CPU module auto exchange will not function.

Operation of when the data logging function is used

If data is backed up during execution of the data logging function and the function has been set to be started automatically when the operating status of the CPU module is changed to RUN, the data logging function will be automatically executed when the status of the CPU module changes to RUN after the restoration processing. To restart the data logging function after the restoration processing without the above setting, use the CPU module logging configuration tool.

When the SFC program is restarted from where the program was stopped

Specify the continue start. When the continue start has not been specified, the SFC program will be started from the block 0 and step 0 even though the bit 15 of SD955 is on (the continue start is executed).

When using IP address change function

If executing backup when an IP address is stored in the IP address storage area (system memory), the IP address will change at the following timing during restoration.

- Restoration triggered by turning on SM1354: When CPU module power is turned OFF→ON or reset after restoration.
- Automatic restoration triggered by SD955: When restoration is executed.
- Restoration triggered by CPU module auto exchange: When restoration is executed.

Data protected by security functions

■File password function

Unlock the file passwords of the files in the backup target CPU module. If any files to which file passwords have been set exist in the CPU module, the files are not restored.

■Security key authentication function

Locked programs can be restored regardless of whether security keys have been written or not. However, when the security key has not been written to the CPU module after the restoration processing, the program cannot be executed. Restore unlocked backup data or set the same security key.

Abnormal completion of restoration

Since the restoration processing will be completed with an error, do not execute the restoration processing in the following cases.

- Data in a backup folder has been deleted. (Do not delete the data in backup folders that are likely to be used for restoration.)
- Backup data has problems. (Backup data has been changed or the CPU module was powered off during execution of the backup processing.)

When the same name folder or file exists in the restoration target CPU module

If the name of a folder or file in the restoration target CPU module and the name of a folder or file in backup data are identical, the folder or file in the module will be overwritten by that in the backup data.

Status of the restoration destination CPU module

If the status of the restoration destination CPU module differs from that of the CPU module at the backup processing (such as programs or parameters), the restoration may not be executed.

When the backup data to be restored is backed up in a different status from that of the restoration destination CPU module, store 0 (All target data) to SD954 (Restoration target data setting) and execute the automatic restoration.

Applying the restored data

There are parameters that are applied only when the CPU module power is turned OFF→ON or reset. Thus, if the data is restored while operation is stopped, and then the state is changed from STOP to RUN, the CPU module may not run with the backed up data. In this case, turn OFF→ON the power or reset the CPU module. The device/label data other than the latch specified devices/labels is initialized when the CPU module power is turned OFF→ON or reset, so restore only the device/label data again as needed.

Stop monitoring at restoration

Stop monitoring before executing the restoration processing.

When the restoration processing is executed, programs, parameters, and device/label values may not be properly monitored because they are changing.

Conditions for executing automatic restoration and CPU module auto exchange

The restoration executed for automatic restoration using SD955 and restoration with CPU module auto exchange differs according to the following conditions.

Auto restoration request (b0 of SD955)	CPU module auto exchange function enable/disable flag (SM9350)	Presence of system file for CPU module auto exchange function	Executed restoration
ON	OFF (Enable)	Existing	Restoration triggered by CPU module auto exchange
ON	OFF (Enable)	None	Automatic restoration using SD955
ON	ON (Disable)	None	Automatic restoration using SD955
ON	ON (Disable)	Existing	Automatic restoration using SD955
OFF	OFF (Enable)	Existing	Restoration triggered by CPU module auto exchange
OFF	OFF (Enable)	None	No process
OFF	ON (Disable)	Existing	No process
OFF	ON (Disable)	None	No process

Time required for completing the restoration processing

It may take some time for restoration to finish if Ethernet communication is in progress.

The relation between the data to be restored and the firmware version of the CPU module

Do not restore the program with the program capacity setting of 128000 steps to the FX5U/FX5UC CPU module with the firmware version earlier than "1.100".

The program may not operate normally.

For the program capacity setting, refer to  Page 127 PROGRAM CAPACITY SETTING.

25 SECURITY FUNCTIONS

These functions prevent theft, tampering, wrongful operation, illegal execution, etc. of a customer's assets saved on a personal computer or in modules in the FX5 system as a result of illegal access by a third party. Use of the security functions according to the following purposes.

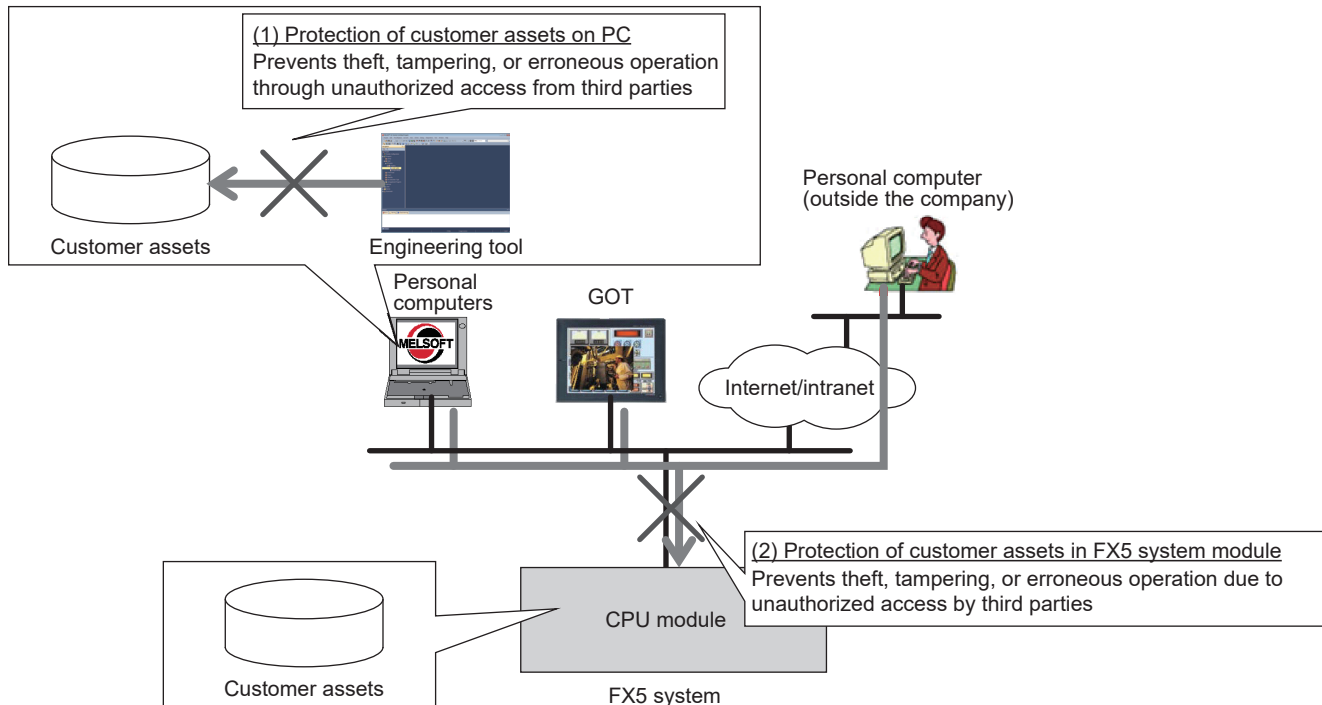

Data protection target	Purpose	Function	Reference
Projects	To prevent illegal accessing and viewing of programs (in program component units). (Password is used.)	Block password function	GX Works3 Operating Manual MELSEC iQ-F FX5 User's Manual (Ethernet Communication) GX Works3 Operating Manual MELSEC iQ-F FX5 User's Manual (Ethernet Communication)
	To prevent illegal accessing and viewing of programs (in program file units). (Security key is used.)	Security key authentication function	
CPU Module	To prevent illegal execution of programs. (Security key is used.)		
	To prevent illegal reading/writing of files. (Password is used.)	File password function	
	Blocks access from an invalid IP address by identifying the IP address of an external device via Ethernet.	IP filter function	
	To limit access from outside a specific communication path. (Password is used.)	Remote password function	

Precautions

When a personal computer registered with a security key is misused by a third party, the outflow of program assets cannot be prevented. For this reason, the customer must adopt sufficient measures as explained below:

- Personal computer antitheft measures (using a wire lock, etc.)
- Management of personal computer users (deletion of unwanted accounts, strict control of login information, introduction of fingerprint authentication, etc.)

Also, when a personal computer registered with a security key malfunctions, locked project data cannot be accessed/viewed or edited. Mitsubishi Electric Corporation cannot be held responsible for any loss that may occur as a result of this with the customer, other individuals or organizations. For this reason, the customer must adopt sufficient measures as explained below:

- Export registered security keys and import them into another personal computer.
- Store files containing exported security keys in a safe location.

26 HIGH-SPEED INPUT/OUTPUT FUNCTION

The high-speed input/output function is explained below.

Each respective function is set by parameters in GX Works3.

High-speed pulse input/output module is supported only for FX5U/FX5UC CPU module.

Function		Reference
High-speed counter function	Normal mode	Page 236
	Pulse density measurement mode	Page 239
	Rotational speed measurement mode	Page 242
FX3-compatible high-speed counter function		Page 292
Pulse width measurement function		Page 302
Pulse catch function	Pulse catch function	Page 319
	FX3-compatible pulse catch function	Page 325
General-purpose input functions		Page 329
PWM function		Page 332
Positioning function		MELSEC iQ-F FX5 User's Manual (Positioning Control - CPU module built-in, High-speed pulse input/output module)

26.1 High-speed Counter Function

High-speed counter function is explained below.

High-speed counter function overview

The high-speed counter is a function that counts the number of high-speed pulse inputs that cannot be counted by a conventional counter, using the general purpose input terminal of the CPU module or high-speed pulse input/output module. High-speed pulse input/output module is supported only for FX5U/FX5UC CPU module.

Depending on the input (module) to be used, each function of the high-speed counter is limited as follows:

Input type	High-speed counter operation mode			High-speed counter dedicated instructions	
	Normal mode	Pulse density measurement mode	Rotational speed measurement mode	HIOEN/DHIOEN instruction	DHSCS, DHSCR, DHSZ instruction
CPU module	○	○	○	○	○
High-speed pulse input/output module*1	○	×	×	○	×

○: Supported, ×: Not supported

The high-speed counter assigns input and function settings by parameters and operates using the HIOEN/DHIOEN instruction.

*1 Only FX5U/FX5UC CPU module is supported.

Point

Parameter setting and the HIOEN/DHIOEN instruction are always required to use the high-speed counter.

High-speed counter parameter setting

High-speed counter channels (input allocation, function) and high-speed counter comparison table, etc., are set by parameters. ( Page 235 High-speed counter parameters)

High-speed counter operation mode

The three high-speed counter operation modes are as follows.

Operation mode is set by parameter. ( Page 235 High-speed counter parameters)

■Normal mode

Select normal mode if you want to use as an ordinary high-speed counter. ( Page 236 High-speed counter (normal mode))

■Pulse density measurement mode

Select pulse density measurement mode if you want to count the number of pulses for a specified amount of time. ( Page 239 High-speed counter (pulse density measurement mode))

■Rotational speed measurement mode

Select rotational speed measurement mode if you want to measure speed for a specified amount of time. ( Page 242 High-speed counter (rotational speed measurement mode))

Input comparison

When the current value and the set value of the high-speed counter are compared and when they match, the output of the specified device can be performed. (normal mode) Also, the current value and the preset value can be compared. (Preset input comparison)

 Page 244 High-speed comparison table

 Page 247 Multiple point output, high-speed comparison tables

The normal input comparison or operation when there is preset input can be set by the parameter setting of the high-speed counter (normal mode).

Item		Description
Preset Input Enable/Disable	Input Comparison Enable/Disable	
Enable	Enable	<ul style="list-style-type: none"> Perform "comparison at counting + output to the specified device". Change the current value to the preset value when the preset input is detected. Perform output to the specified device when the current value matches with the comparison value by the preset input.
Enable	Disable	<ul style="list-style-type: none"> Perform "comparison at counting + output to the specified device". Change the current value to the preset value when the preset input is detected.
Disable	Disable	Perform "comparison at counting + output to the specified device".

Whether or not to perform the preset input comparison can be set by the special devices. ( Page 259 High-speed counter preset input comparison)

Point

Use the parameter setting value of the high-speed counter (normal mode) as the preset value. ( Page 236 High-speed counter (normal mode))

High-speed counter dedicated instructions

The high-speed counter starts and stops counting using the HIOEN/DHIOEN instruction for the high-speed counter. ( MELSEC iQ-F FX5 Programming Manual (Instructions, Standard Functions/Function Blocks))

Other high-speed counter instructions

In addition to the dedicated instructions, there are instructions such as DHSCS, DHSCR, and DHSZ (hereafter referred to as "high-speed comparison instruction") for high-speed counters.

For details, refer to the following.

 MELSEC iQ-F FX5 Programming Manual (Instructions, Standard Functions/Function Blocks)

High-speed counter function execution procedure

The high-speed counter function execution procedure is as follows.

1. Check the specifications of the high-speed counter.

Check specifications such as maximum frequency and type of high-speed counter. (☞ Page 222 High-speed counter specifications)

2. Connect the CPU module to the external device.

For details on wiring to external devices, refer to the following manual

📖 MELSEC iQ-F FX5UJ User's Manual (Hardware)

📖 MELSEC iQ-F FX5U User's Manual (Hardware)

📖 MELSEC iQ-F FX5UC User's Manual (Hardware)

3. Set the parameters.

Set parameters such as channel (CH) of the high-speed counter. (☞ Page 235 High-speed counter parameters)

4. Create the program.

Create program for using the high-speed counter.

5. Run the program.

High-speed counter specifications

High-speed counter specifications are explained below.

Types of high-speed counters

Types of high-speed counters are as follows.

■ 1 phase, 1 input counter (S/W)

Counting method of 1 phase, 1 input counter (S/W) is as follows.

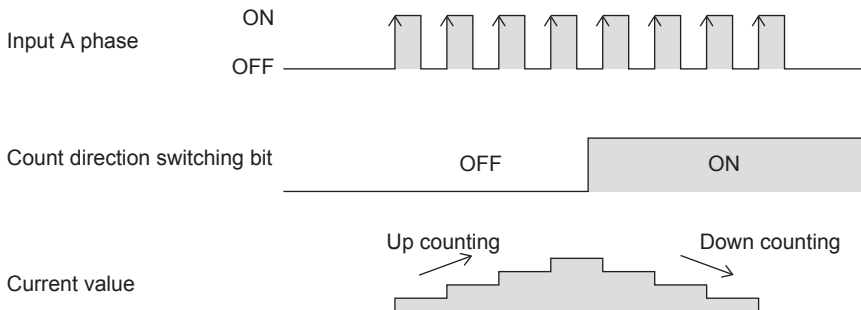

■ 1 phase, 1 input counter (H/W)

Counting method of 1 phase, 1 input counter (H/W) is as follows.

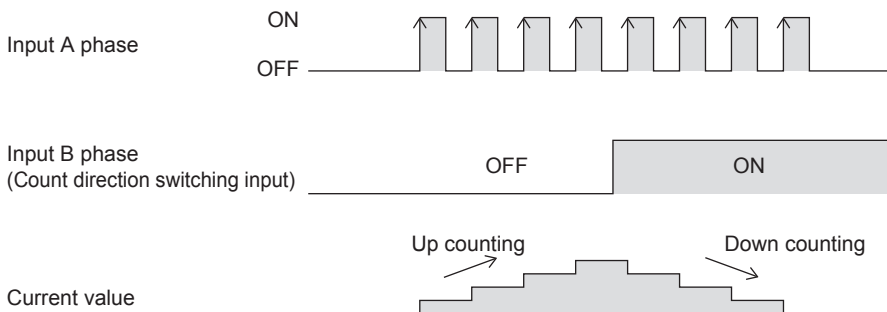

■1 phase, 2 input counter

Counting method of 1 phase, 2 input counter is as follows.

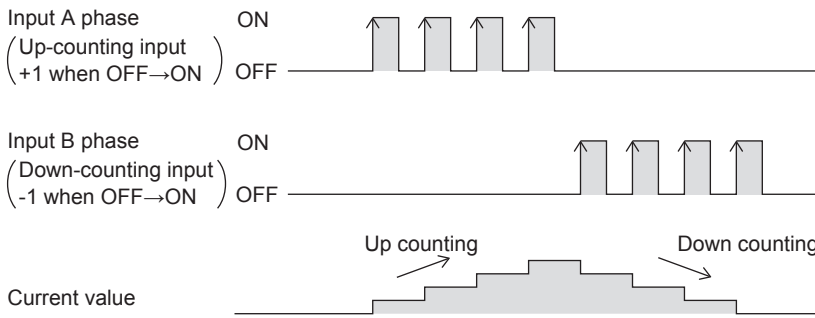

■2 phase, 2 input counter [1 edge count]

Counting method of 2 phase, 2 input counter [1 edge count] is as follows.

Up/down counter	Counter timing
At up-counting	1 count up when input A phase is ON and input B phase switches OFF→ON
At down-counting	1 count down when input A phase is ON and input B phase switches ON→OFF

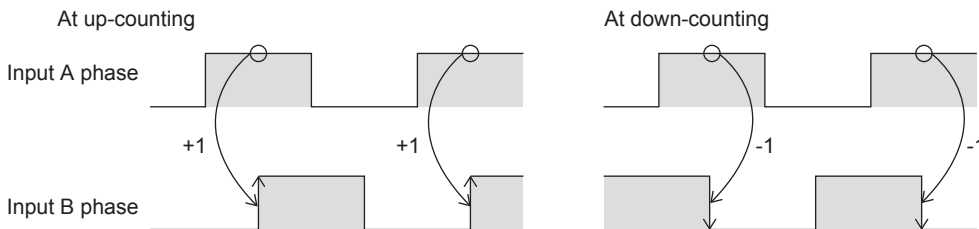

■2 phase, 2 input counter [2 edge count]

Counting method of 2 phase, 2 input counter [2 edge count] is as follows.

Up/down counter	Counter timing
At up-counting	1 count up when input A phase is ON and input B phase switches OFF→ON 1 count up when input A phase is OFF and input B phase switches ON→OFF
At down-counting	1 count down when input A phase is ON and input B phase switches ON→OFF 1 count down when input A phase is OFF and input B phase switches OFF→ON

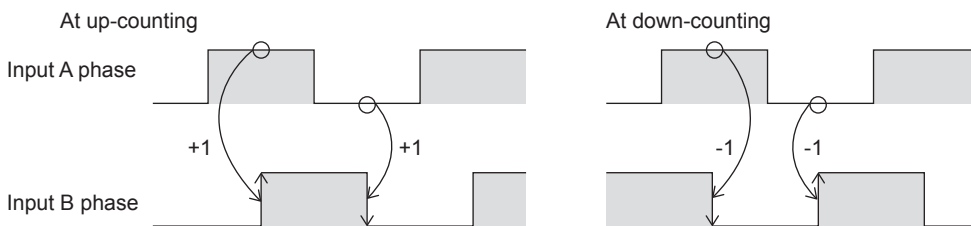

■2 phase, 2 input counter [4 edge count]

Counting method of 2 phase, 2 input counter [4 edge count] is as follows.

Up/down counter	Counter timing
At up-counting	1 count up when input B phase is OFF and input A phase switches OFF→ON 1 count up when input A phase is ON and input B phase switches OFF→ON 1 count up when input B phase is ON and input A phase switches ON→OFF 1 count up when input A phase is OFF and input B phase switches ON→OFF
At down-counting	1 count down when input A phase is OFF and input B phase switches OFF→ON 1 count down when input B phase is ON and input A phase switches OFF→ON 1 count down when input A phase is ON and input B phase switches ON→OFF 1 count down when input B phase is OFF and input A phase switches ON→OFF

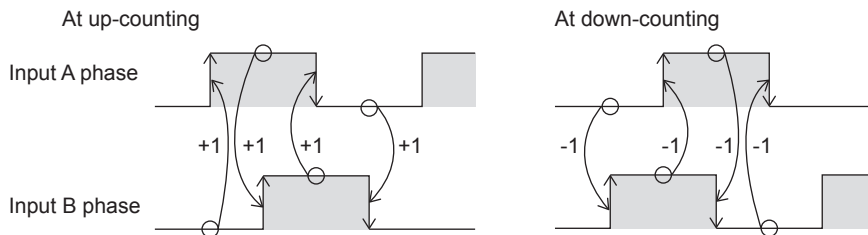

■Internal clock

Counting method of internal clock is as follows.

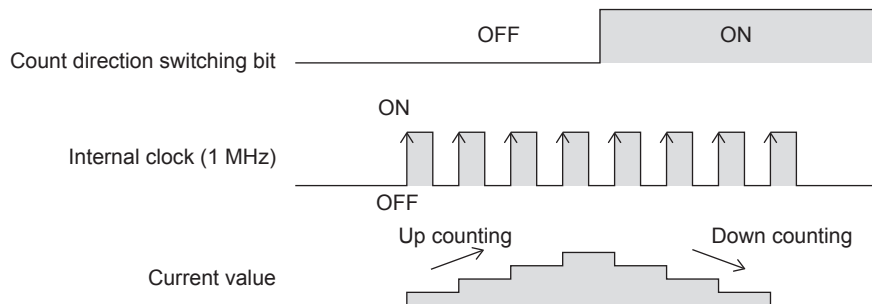

Point

Under ordinary circumstances, the internal clock counts up/down by 1 MHz clock. External input is not used.

High-speed counter form

High-speed counter form becomes ring counter depending on the ring length setting.

■When ring length is set

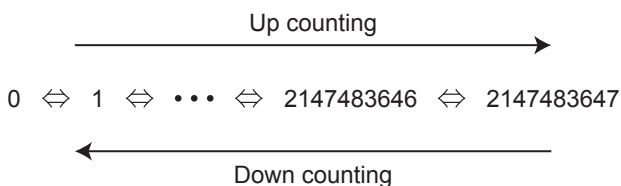

■When ring length is not set (ring counter)

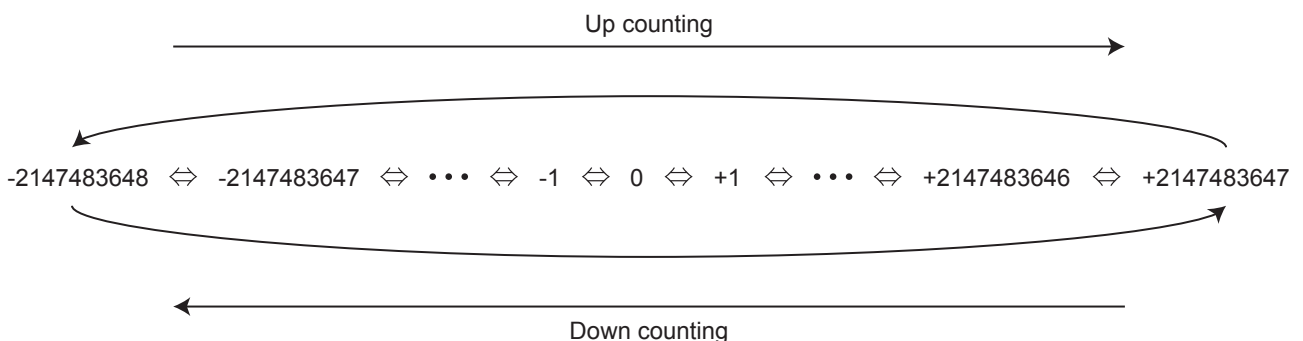

Maximum frequency

The maximum frequency that each type of counter can count is as follows.

For details concerning maximum frequency by input assignment, refer to  Page 230 Input assignment-wise / maximum frequency for high-speed counters.

■FX5UJ CPU module

Counter type	Maximum frequency
1 phase, 1 input counter (S/W)	100 kHz
1 phase, 1 input counter (H/W)	100 kHz
1 phase, 2 input counter	100 kHz
2 phase, 2 input counter [1 edge count]	100 kHz
2 phase, 2 input counter [2 edge count]	50 kHz
2 phase, 2 input counter [4 edge count]	25 kHz
Internal clock	1 MHz (fixed)

■FX5U/FX5UC CPU module

Counter type	Maximum frequency
1 phase, 1 input counter (S/W)	200 kHz
1 phase, 1 input counter (H/W)	200 kHz
1 phase, 2 input counter	200 kHz
2 phase, 2 input counter [1 edge count]	200 kHz
2 phase, 2 input counter [2 edge count]	100 kHz
2 phase, 2 input counter [4 edge count]	50 kHz
Internal clock	1 MHz (fixed)

Precautions

- The input circuit has restrictions for maximum frequency.

FX5UJ CPU module		Maximum frequency	
X0, X1, X3, X4		100 kHz	
X2, X5, X6, X7		10 kHz	
FX5U-32M□, FX5UC-32M□	FX5U-64M□, FX5U-80M□, FX5UC-64M□, FX5UC-96M□	High-speed pulse input/output module*1	Maximum frequency
X0 to X5	X0 to X7	X□ to X□+5	200 kHz
X6 to X17	X10 to X17	X□+6, X□+7	10 kHz

*1 □: Head input number for each high-speed pulse input/output module

- If input response time is set, maximum frequency is affected by the setting value.
- Under ordinary circumstances, the internal clock counts at 1 MHz (fixed) during operation.

Matched output performance

■CPU module

If output is to Y0 to Y17 using high-speed comparison instructions (DHSCS, DHSCR, DHSZ instruction), high-speed comparison table, or multiple point output high-speed comparison table, time from pulse input→comparison of count value (match)→output to Y is follows.

- FX5UJ CPU module: 10 μ s + input response time
- FX5U/FX5UC CPU module: 5 μ s + input response time

If output is to Y20 or subsequent, time from pulse input to output is affected by communication and user interrupt.

■High-speed pulse input/output module

The matched output from the high-speed comparison table is possible only in the same module.

The time from pulse input→comparison of count value (match)→output to Y is 5 μ s + the input response time.

■Operation diagram

An operation diagram is shown below. (Comparison value: 5)

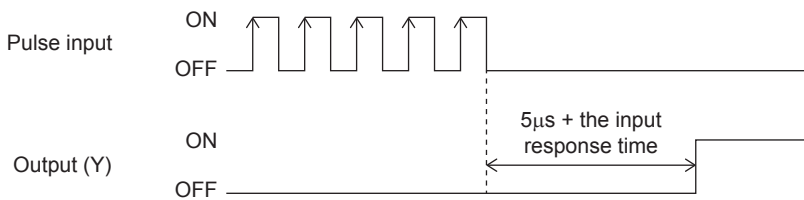

Count range

-2147483648 to +2147483647. These are signed 32-bit ring counters.

Ring length setting is however in the range of 0 to 2147483647.

Assignment for high-speed counters

Input assignment for high-speed counters

Assignment for input devices of high-speed counters is set by parameters.

Assignment is determined according to functions set for each channels by parameter.

When using internal clock, assignment is same as 1-phase, 1-count (S/W) and A phase is not used.

Input assignment of high-speed counters is as follows.

■FX5UJ CPU module

CH	High-speed counter type	X0	X1	X2	X3	X4	X5	X6	X7	X10	X11	X12	X13	X14	X15	X16	X17
CH1	1-phase 1-count (S/W)	A	P					E									
	1-phase 1-count (H/W)	A	B	P				E									
	1-phase 2-count	A	B	P				E									
	2-phase 2-count	A	B	P				E									
CH2	1-phase 1-count (S/W)		A	P					E								
	1-phase 1-count (H/W)		A	B	P				E								
	1-phase 2-count		A	B	P				E								
CH3	1-phase 1-count (S/W)			A	P					E							
	1-phase 1-count (H/W)			A	B	P				E							
	1-phase 2-count			A	B	P				E							
CH4	1-phase 1-count (S/W)				A	P					E						
	1-phase 1-count (H/W)				A	B	P				E						
	1-phase 2-count				A	B	P				E						
	2-phase 2-count				A	B	P				E						
CH5	1-phase 1-count (S/W)					A	P					E					
	1-phase 1-count (H/W)					A	B	P				E					
	1-phase 2-count					A	B	P				E					
CH6	1-phase 1-count (S/W)						A	P					E				
	1-phase 1-count (H/W)						A	B	P				E				
	1-phase 2-count						A	B	P				E				
	2-phase 2-count						A	B	P				E				
CH7	1-phase 1-count (S/W)							A	P					E			
	1-phase 1-count (H/W)							A	B	P				E			
	1-phase 2-count							A	B	P				E			
	2-phase 2-count							A	B	P				E			
CH8	1-phase 1-count (S/W)								A	P					E		
	1-phase 1-count (H/W)								A	B	P				E		

A: Input A phase (In the case of 1-phase 1-count, pulse input is employed and in the case of 1-phase 2-count, pulse input of down-counting direction is employed.)

B: Input B phase (In the case of 1-phase 1-count (H/W), direction switch input is employed and in the case of 1-phase 2-count, pulse input of down-counting direction is employed.)

P: Input external preset

E: Input external enable

■FX5U/FX5UC CPU module

CH	High-speed counter type	X0	X1	X2	X3	X4	X5	X6	X7	X10	X11	X12	X13	X14	X15	X16	X17
CH1	1-phase 1-count (S/W)	A								P	E						
	1-phase 1-count (H/W)	A	B							P	E						
	1-phase 2-count	A	B							P	E						
	2-phase 2-count	A	B							P	E						
CH2	1-phase 1-count (S/W)		A									P	E				
	1-phase 1-count (H/W)			A	B							P	E				
	1-phase 2-count			A	B							P	E				
	2-phase 2-count			A	B							P	E				
CH3	1-phase 1-count (S/W)			A										P	E		
	1-phase 1-count (H/W)					A	B							P	E		
	1-phase 2-count					A	B							P	E		
	2-phase 2-count					A	B							P	E		
CH4	1-phase 1-count (S/W)				A											P	E
	1-phase 1-count (H/W)							A	B							P	E
	1-phase 2-count							A	B							P	E
	2-phase 2-count							A	B							P	E
CH5	1-phase 1-count (S/W)					A				P	E						
	1-phase 1-count (H/W)									A	B	P	E				
	1-phase 2-count									A	B	P	E				
	2-phase 2-count									A	B	P	E				
CH6	1-phase 1-count (S/W)						A					P	E				
	1-phase 1-count (H/W)											A	B	P	E		
	1-phase 2-count											A	B	P	E		
	2-phase 2-count											A	B	P	E		
CH7	1-phase 1-count (S/W)							A						P	E		
	1-phase 1-count (H/W)													A	B	P	E
	1-phase 2-count													A	B	P	E
	2-phase 2-count													A	B	P	E
CH8	1-phase 1-count (S/W)								A							P	E
	1-phase 1-count (H/W)															A	B
	1-phase 2-count															A	B
	2-phase 2-count															A	B
CH1 to CH8	Internal clock	Not used															

A: Input A phase

B: Input B phase (direction switch input is however employed in the case of 1-phase 1-count [H/W])

P: Input external preset

E: Input external enable

■High-speed pulse input/output module

□ of each input is the head input number for high-speed pulse input/output module.

CH	High-speed counter type	X□	X□+1	X□+2	X□+3	X□+4	X□+5	X□+6	X□+7	
CH9, CH11, CH13, CH15	1-phase 1-count (S/W)	A	P					E		
	1-phase 1-count (H/W)	A	B	P				E		
CH10, CH12, CH14, CH16	1-phase 2-count	A	B	P				E		
	2-phase 2-count	A	B	P				E		
CH9 to CH16	1-phase 1-count (S/W)				A	P			E	
	1-phase 1-count (H/W)				A	B	P		E	
	1-phase 2-count				A	B	P		E	
	2-phase 2-count				A	B	P		E	
CH9 to CH16	Internal clock	Not used								

A: Input A phase

B: Input B phase (direction switch input is however employed in the case of 1-phase 1-count [H/W])

P: Input external preset

E: Input external enable

Point 

The high-speed pulse input/output module channel numbers are assigned as described below. From nearest to the CPU module, the high-speed pulse input/output modules are ordered as the first module, second module, etc.

- High-speed pulse input/output module first module: CH9, CH10
- High-speed pulse input/output module second module: CH11, CH12
- High-speed pulse input/output module third module: CH13, CH14
- High-speed pulse input/output module fourth module: CH15, CH16

Input assignment-wise / maximum frequency for high-speed counters

Input assignment-wise maximum frequency for high-speed counters is as follows.

■FX5UJ CPU module

CH	High-speed counter type	X0	X1	X2	X3	X4	X5	X6	X7	X10	X11	X12	X13	X14	X15	X16	X17	Maximum frequency
CH1	1-phase 1-count (S/W)	A	P					E										100 kHz
	1-phase 1-count (H/W)	A	B	P				E										100 kHz
	1-phase 2-count	A	B	P				E										100 kHz
	2-phase 2-count [1 edge count]	A	B	P				E										100 kHz
	2-phase 2-count [2 edge count]	A	B	P				E										50 kHz
	2-phase 2-count [4 edge count]	A	B	P				E										25 kHz
CH2	1-phase 1-count (S/W)		A	P					E									100 kHz
	1-phase 1-count (H/W)		A	B	P				E									100 kHz
	1-phase 2-count		A	B	P				E									10 kHz
CH3	1-phase 1-count (S/W)			A	P					E								10 kHz
	1-phase 1-count (H/W)			A	B	P				E								10 kHz
	1-phase 2-count			A	B	P				E								10 kHz
CH4	1-phase 1-count (S/W)				A	P					E							100 kHz
	1-phase 1-count (H/W)				A	B	P				E							100 kHz
	1-phase 2-count				A	B	P				E							100 kHz
	2-phase 2-count [1 edge count]				A	B	P				E							100 kHz
	2-phase 2-count [2 edge count]				A	B	P				E							50 kHz
	2-phase 2-count [4 edge count]				A	B	P				E							25 kHz
CH5	1-phase 1-count (S/W)					A	P					E						100 kHz
	1-phase 1-count (H/W)					A	B	P				E						100 kHz
	1-phase 2-count					A	B	P				E						10 kHz
CH6	1-phase 1-count (S/W)						A	P					E					10 kHz
	1-phase 1-count (H/W)						A	B	P				E					10 kHz
	1-phase 2-count						A	B	P				E					10 kHz
	2-phase 2-count [1 edge count]						A	B	P				E					10 kHz
	2-phase 2-count [2 edge count]						A	B	P				E					5 kHz
	2-phase 2-count [4 edge count]						A	B	P				E					2.5 kHz
CH7	1-phase 1-count (S/W)							A	P					E				10 kHz
	1-phase 1-count (H/W)							A	B	P				E				10 kHz
	1-phase 2-count							A	B	P				E				10 kHz
	2-phase 2-count [1 edge count]							A	B	P				E				10 kHz
	2-phase 2-count [2 edge count]							A	B	P				E				5 kHz
	2-phase 2-count [4 edge count]							A	B	P				E				2.5 kHz
CH8	1-phase 1-count (S/W)								A	P					E			10 kHz
	1-phase 1-count (H/W)								A	B	P				E			10 kHz

A: Input A phase, B: Input A phase, P: Input external preset, E: Input external enable

■FX5U-32M□, FX5UC-32M□



- X6 to X17 are input frequencies up to 10 kHz, regardless of maximum frequency value.
- Preset input and Enable Input are input frequencies up to 10 kHz, regardless of maximum frequency value.

CH	High-speed counter type	X0	X1	X2	X3	X4	X5	X6	X7	X10	X11	X12	X13	X14	X15	X16	X17	Maximum frequency
CH1	1-phase 1-count (S/W)	A								P	E							200 kHz
	1-phase 1-count (H/W)	A	B							P	E							200 kHz
	1-phase 2-count	A	B							P	E							200 kHz
	2-phase 2-count [1 edge count]	A	B							P	E							200 kHz
	2-phase 2-count [2 edge count]	A	B							P	E							100kHz
	2-phase 2-count [4 edge count]	A	B							P	E							50 kHz
CH2	1-phase 1-count (S/W)		A									P	E					200 kHz
	1-phase 1-count (H/W)			A	B							P	E					200 kHz
	1-phase 2-count			A	B							P	E					200 kHz
	2-phase 2-count [1 edge count]			A	B							P	E					200 kHz
	2-phase 2-count [2 edge count]			A	B							P	E					100 kHz
	2-phase 2-count [4 edge count]			A	B							P	E					50 kHz
CH3	1-phase 1-count (S/W)			A										P	E			200 kHz
	1-phase 1-count (H/W)					A	B							P	E			200 kHz
	1-phase 2-count					A	B							P	E			200 kHz
	2-phase 2-count [1 edge count]					A	B							P	E			200 kHz
	2-phase 2-count [2 edge count]					A	B							P	E			100 kHz
	2-phase 2-count [4 edge count]					A	B							P	E			50 kHz
CH4	1-phase 1-count (S/W)				A											P	E	200 kHz
	1-phase 1-count (H/W)							A	B							P	E	10 kHz
	1-phase 2-count							A	B							P	E	10 kHz
	2-phase 2-count [1 edge count]							A	B							P	E	10 kHz
	2-phase 2-count [2 edge count]							A	B							P	E	5 kHz
	2-phase 2-count [4 edge count]							A	B							P	E	2.5 kHz
CH5	1-phase 1-count (S/W)					A				P	E							200 kHz
	1-phase 1-count (H/W)									A	B	P	E					10 kHz
	1-phase 2-count									A	B	P	E					10 kHz
	2-phase 2-count [1 edge count]									A	B	P	E					10 kHz
	2-phase 2-count [2 edge count]									A	B	P	E					5 kHz
	2-phase 2-count [4 edge count]									A	B	P	E					2.5 kHz

CH	High-speed counter type	X0	X1	X2	X3	X4	X5	X6	X7	X10	X11	X12	X13	X14	X15	X16	X17	Maximum frequency
CH6	1-phase 1-count (S/W)						A					P	E					200 kHz
	1-phase 1-count (H/W)											A	B	P	E			10 kHz
	1-phase 2-count											A	B	P	E			10 kHz
	2-phase 2-count [1 edge count]											A	B	P	E			10 kHz
	2-phase 2-count [2 edge count]											A	B	P	E			5 kHz
	2-phase 2-count [4 edge count]											A	B	P	E			2.5 kHz
CH7	1-phase 1-count (S/W)							A						P	E			10 kHz
	1-phase 1-count (H/W)													A	B	P	E	10 kHz
	1-phase 2-count													A	B	P	E	10 kHz
	2-phase 2-count [1 edge count]													A	B	P	E	10 kHz
	2-phase 2-count [2 edge count]													A	B	P	E	5 kHz
	2-phase 2-count [4 edge count]													A	B	P	E	2.5 kHz
CH8	1-phase 1-count (S/W)								A							P	E	10 kHz
	1-phase 1-count (H/W)															A	B	10 kHz
	1-phase 2-count															A	B	10 kHz
	2-phase 2-count [1 edge count]															A	B	10 kHz
	2-phase 2-count [2 edge count]															A	B	5 kHz
	2-phase 2-count [4 edge count]															A	B	2.5 kHz

A: Input A phase, B: Input A phase, P: Input external preset, E: Input external enable

■FX5U-64M□, FX5U-80M□, FX5UC-64M□, FX5UC-96M□



- X10 to X17 are input frequencies up to 10 kHz, regardless of maximum frequency value.
- Preset input and Enable Input are input frequencies up to 10 kHz, regardless of maximum frequency value.

CH	High-speed counter type	X0	X1	X2	X3	X4	X5	X6	X7	X10	X11	X12	X13	X14	X15	X16	X17	Maximum frequency
CH1	1-phase 1-count (S/W)	A								P	E							200 kHz
	1-phase 1-count (H/W)	A	B							P	E							200 kHz
	1-phase 2-count	A	B							P	E							200 kHz
	2-phase 2-count [1 edge count]	A	B							P	E							200 kHz
	2-phase 2-count [2 edge count]	A	B							P	E							100 kHz
	2-phase 2-count [4 edge count]	A	B							P	E							50 kHz
CH2	1-phase 1-count (S/W)		A									P	E					200 kHz
	1-phase 1-count (H/W)			A	B							P	E					200 kHz
	1-phase 2-count			A	B							P	E					200 kHz
	2-phase 2-count [1 edge count]			A	B							P	E					200 kHz
	2-phase 2-count [2 edge count]			A	B							P	E					100 kHz
	2-phase 2-count [4 edge count]			A	B							P	E					50 kHz

CH	High-speed counter type	X0	X1	X2	X3	X4	X5	X6	X7	X10	X11	X12	X13	X14	X15	X16	X17	Maximum frequency
CH3	1-phase 1-count (S/W)			A										P	E			200 kHz
	1-phase 1-count (H/W)					A	B							P	E			200 kHz
	1-phase 2-count					A	B							P	E			200 kHz
	2-phase 2-count [1 edge count]					A	B							P	E			200 kHz
	2-phase 2-count [2 edge count]					A	B							P	E			100 kHz
	2-phase 2-count [4 edge count]					A	B							P	E			50 kHz
CH4	1-phase 1-count (S/W)				A											P	E	200 kHz
	1-phase 1-count (H/W)							A	B							P	E	200 kHz
	1-phase 2-count							A	B							P	E	200 kHz
	2-phase 2-count [1 edge count]							A	B							P	E	200 kHz
	2-phase 2-count [2 edge count]							A	B							P	E	100 kHz
	2-phase 2-count [4 edge count]							A	B							P	E	50 kHz
CH5	1-phase 1-count (S/W)					A				P	E							200 kHz
	1-phase 1-count (H/W)									A	B	P	E					10 kHz
	1-phase 2-count									A	B	P	E					10 kHz
	2-phase 2-count [1 edge count]									A	B	P	E					10 kHz
	2-phase 2-count [2 edge count]									A	B	P	E					5 kHz
	2-phase 2-count [4 edge count]									A	B	P	E					2.5 kHz
CH6	1-phase 1-count (S/W)						A					P	E					200 kHz
	1-phase 1-count (H/W)											A	B	P	E			10 kHz
	1-phase 2-count											A	B	P	E			10 kHz
	2-phase 2-count [1 edge count]											A	B	P	E			10 kHz
	2-phase 2-count [2 edge count]											A	B	P	E			5 kHz
	2-phase 2-count [4 edge count]											A	B	P	E			2.5 kHz
CH7	1-phase 1-count (S/W)							A						P	E			200 kHz
	1-phase 1-count (H/W)													A	B	P	E	10 kHz
	1-phase 2-count													A	B	P	E	10 kHz
	2-phase 2-count [1 edge count]													A	B	P	E	10 kHz
	2-phase 2-count [2 edge count]													A	B	P	E	5 kHz
	2-phase 2-count [4 edge count]													A	B	P	E	2.5 kHz
CH8	1-phase 1-count (S/W)								A							P	E	200 kHz
	1-phase 1-count (H/W)															A	B	10 kHz
	1-phase 2-count															A	B	10 kHz
	2-phase 2-count [1 edge count]															A	B	10 kHz
	2-phase 2-count [2 edge count]															A	B	5 kHz
	2-phase 2-count [4 edge count]															A	B	2.5 kHz

A: Input A phase, B: Input A phase, P: Input external preset, E: Input external enable

High-speed pulse input/output module

Point

- X□+6 and X□+7 are input frequencies up to 10 kHz, regardless of maximum frequency value.
- Preset input and Enable Input are input frequencies up to 10 kHz, regardless of maximum frequency value.

□ of each input is the head input number for high-speed pulse input/output module.

CH	High-speed counter type	X□	X□+1	X□+2	X□+3	X□+4	X□+5	X□+6	X□+7	Maximum frequency
CH9, CH11, CH13, CG15	1-phase 1-count (S/W)	A	P					E		200 kHz
	1-phase 1-count (H/W)	A	B	P				E		200 kHz
	1-phase 2-count	A	B	P				E		200 kHz
	2-phase 2-count [1 edge count]	A	B	P				E		200 kHz
	2-phase 2-count [2 edge count]	A	B	P				E		100 kHz
	2-phase 2-count [4 edge count]	A	B	P				E		50 kHz
CH10, CH12, CH14, CH16	1-phase 1-count (S/W)				A	P			E	200 kHz
	1-phase 1-count (H/W)				A	B	P		E	200 kHz
	1-phase 2-count				A	B	P		E	200 kHz
	2-phase 2-count [1 edge count]				A	B	P		E	200 kHz
	2-phase 2-count [2 edge count]				A	B	P		E	100 kHz
	2-phase 2-count [4 edge count]				A	B	P		E	50 kHz

A: Input A phase, B: Input A phase, P: Input external preset, E: Input external enable

High-speed counter parameters

High-speed counter parameters are explained below.

High-speed counter parameters are set by GX Works3.

Outline of parameters

High-speed counter settings, high-speed comparison table, multiple point high-speed comparison table setting and input response time are set by parameters.

The primary items that can be set by parameters are as follows.

- Basic settings
- High-speed comparison table setting
- Multiple point output high-speed table setting
- Input response time setting

Parameter setting

High-speed counter parameter setting method is explained below.

For parameter setting of each operation, refer to the following.

- For high-speed counters (normal mode), refer to [☞ Page 236 High-speed counter \(normal mode\)](#).
- For high-speed counter (pulse density measurement mode), refer to [☞ Page 239 High-speed counter \(pulse density measurement mode\)](#).
- For high-speed counter (rotational speed measurement mode), refer to [☞ Page 242 High-speed counter \(rotational speed measurement mode\)](#).
- For high-speed comparison table, refer to [☞ Page 244 High-speed comparison table](#).
- For multiple point output, high-speed comparison tables, refer to [☞ Page 247 Multiple point output, high-speed comparison tables](#).
- For input response time, refer to [☞ Page 329 General-purpose Input Functions](#).

Point

Parameters are enabled when the CPU module is powered ON or after a reset. In addition, operations different from the parameter settings are possible by transferring values to special relays and special registers while changing these values in the program.

For details concerning special relays and special registers for high-speed counters, refer to [☞ Page 250 Special relay list](#), [☞ Page 264 Special registers list](#).

High-speed counter (normal mode)

Normal mode for high-speed counters is explained below.

Use normal mode if you want to use as an ordinary high-speed counter.

Parameter setting

Set operation mode to normal mode by high-speed counter parameter setting.

Sets detailed settings for channel used.

■CPU module

Navigation window ⇒ [Parameter] ⇒ [FX5UJCPU] or [FX5UCPU] ⇒ [Module Parameter] ⇒ [High Speed I/O] ⇒ "Input Function" ⇒ "High Speed Counter" ⇒ "Detail Setting" ⇒ "Basic Settings"

Window

Item	CH1	CH2	CH3
<input type="checkbox"/> Use/Do Not Use Counter	Set whether to use counter or not.		
Use/Not Use	Enable	Enable	Enable
<input type="checkbox"/> Operation Mode	Set operation mode.		
Operation Mode	Normal Mode	Normal Mode	Normal Mode
<input type="checkbox"/> Pulse Input Mode	Set pulse input mode.		
Pulse Input Mode	1-Phase 1 Input (S/W Up/Down Switch)	1 Phase 2 Input	2 Phase 4 Multiple
<input type="checkbox"/> Preset Input	Set preset input.		
Preset Input Enable/Disable	Disable	Enable	Disable
Input logic	Positive Logic	Positive Logic	Positive Logic
Input Comparison Enable/Disable	Disable	Disable	Disable
Control Switch	Rising	Falling	Rising
<input type="checkbox"/> Preset Value			
Preset Value	0	100	200
<input type="checkbox"/> Enable Input	Set enable input.		
Enable Input Enable/Disable	Disable	Disable	Enable
Input logic	Positive Logic	Positive Logic	Negative Logic
<input type="checkbox"/> Ring Length Setting	Set ring length.		
Ring Length Enable/Disable	Disable	Disable	Enable
Ring Length			50000
<input type="checkbox"/> Measurement Unit Time	Set the measurement unit time (ms) for the pulse density measurement mode and rotation speed measurement mode.		
Measurement Unit Time			
<input type="checkbox"/> No. of Pulse per Rotation	Set the number of pulses per rotation when using the rotation speed measurement mode.		
No. of Pulse per Rotation			

Displayed items

Item	Description	Setting range	Default
Use/Not Use	Set whether use counter or not.	<ul style="list-style-type: none"> • Disable • Enable 	Disable
Operation Mode	Set operation mode.	<ul style="list-style-type: none"> • Normal Mode • Pulse Density Assumption Mode • Rotation Speed Measurement Mode 	—
Pulse Input Mode	Set pulse input mode.	<ul style="list-style-type: none"> • 1-Phase 1 Input (S/W Up/Down Switch) • 1-Phase 1 Input (H/W Up/Down Switch) • 1 Phase 2 Input • 2 Phase 1 Multiple • 2 Phase 2 Multiple • 2 Phase 4 Multiple • Internal Clock (1MHz) 	—
Preset Input Enable/Disable	Set the preset value when preset input is enabled. Change the current value to the preset value when the preset is detected. The preset value cannot be set when the preset input is disabled.	<ul style="list-style-type: none"> • Disable • Enable 	—
Input logic	Sets preset input logic when preset input is enabled.	<ul style="list-style-type: none"> • Positive Logic • Negative Logic 	—

Item	Description	Setting range	Default
Input Comparison Enable/Disable	Perform output to the specified device when input comparison is enabled and the current value matches with the comparison value by the preset input. Output to the specified device is not performed when input comparison is disabled and the current value matches with the comparison value by the preset input.	<ul style="list-style-type: none"> • Disable • Enable 	—
Control Switch	Sets preset execution timing when preset input is enabled.	<ul style="list-style-type: none"> • Rising • Falling • Rising + Falling Edge • Always During Input ON 	—
Preset Value	Sets preset value when preset input is enabled.	-2147483648 to +2147483647	—
Enable Input Enable/Disable	Set whether to "enable" or "disable" the enable input.	<ul style="list-style-type: none"> • Disable • Enable 	—
Input logic	Set the enable input logic value.	<ul style="list-style-type: none"> • Positive Logic • Negative Logic 	—
Ring Length Enable/Disable	Sets whether to "enable" or "disable" the ring length for ring counters.	<ul style="list-style-type: none"> • Disable • Enable 	—
Ring Length	Sets ring length when ring length setting is enabled.	2 to 2147483648	—
Measurement Unit Time	Not available for high-speed counters (normal mode).	—	—
No. of Pulse per Rotation			

High-speed pulse input/output module

Add the high-speed pulse input/output module.

Navigation window ⇒ [Parameter] ⇒ [Module Information] ⇒ Right-click ⇒ Add New Module

After adding the high-speed pulse input/output module, make settings on the the screen displayed from the following operation.

Navigation window ⇒ [Parameter] ⇒ [Module Information] ⇒ [1 to 16 (high-speed pulse input/output module)] ⇒ [Module Parameter] ⇒ "Input Function" ⇒ "High Speed Counter" ⇒ "Detailed Setting" ⇒ "Basic Settings"

Window

Item	CH9	CH10
Use/Do Not Use Counter	Set whether to use counter or not.	
Use/Not Use	Enable	Enable
Operation Mode	Set operation mode.	
Operation Mode	Normal Mode	Normal Mode
Pulse Input Mode	Set pulse input mode.	
Pulse Input Mode	1-Phase 1 Input (S/W Up/Down Switch)	1-Phase 1 Input (S/W Up/Down Switch)
Preset Input	Set preset input.	
Preset Input Enable/Disable	Disable	Enable
Input logic	Positive Logic	Positive Logic
Input Comparison Enable/Disable	Disable	Enable
Control Switch	Rising	Falling
Preset Value		
Preset Value	0	5000
Enable Input	Set enable input.	
Enable Input Enable/Disable	Disable	Enable
Input logic	Positive Logic	Negative Logic
Ring Length Setting	Set ring length.	
Ring Length Enable/Disable	Disable	Enable
Ring Length		10000

Shown above is the screen at the time when the first high-speed pulse input/output module is selected.



Displayed items

Item	Description	Setting range	Default
Use/Not Use	Set whether use counter or not.	<ul style="list-style-type: none"> • Disable • Enable 	Disable
Operation Mode	Set operation mode.	Normal Mode	—

Item	Description	Setting range	Default
Pulse Input Mode	Set pulse input mode.	<ul style="list-style-type: none"> • 1-Phase 1 Input (S/W Up/Down Switch) • 1-Phase 1 Input (H/W Up/Down Switch) • 1 Phase 2 Input • 2 Phase 1 Multiple • 2 Phase 2 Multiple • 2 Phase 4 Multiple • Internal Clock (1MHz) 	—
Preset Input Enable/Disable	Set whether to "enable" or "disable" the preset input of counter.	<ul style="list-style-type: none"> • Disable • Enable 	—
Input logic	Sets preset input logic when preset input is enabled.	<ul style="list-style-type: none"> • Positive Logic • Negative Logic 	—
Input Comparison Enable/Disable	Sets whether to "enable" or "disable" input comparison when preset input is enabled.	<ul style="list-style-type: none"> • Disable • Enable 	—
Control Switch	Sets preset execution timing when preset input is enabled.	<ul style="list-style-type: none"> • Rising • Falling • Rising + Falling Edge • Always During Input ON 	—
Preset Value	Sets preset value when preset input is enabled.	-2147483648 to +2147483647	—
Enable Input Enable/Disable	Set whether to "enable" or "disable" the enable input.	<ul style="list-style-type: none"> • Disable • Enable 	—
Input logic	Set the enable input logic value.	<ul style="list-style-type: none"> • Positive Logic • Negative Logic 	—
Ring Length Enable/Disable	Sets whether to "enable" or "disable" the ring length for ring counters.	<ul style="list-style-type: none"> • Disable • Enable 	—
Ring Length	Sets ring length when ring length setting is enabled.	2 to 2147483648	—

Point

Parameters are enabled when the CPU module is powered ON or after a reset. In addition, operations different from the parameter settings are possible by transferring values to special relays and special registers while changing these values in the program.

For details concerning special relays and special registers for high-speed counters, refer to  Page 250 Special relay list,  Page 264 Special registers list.

Starting/stopping high-speed counter measurement

High-speed counters cannot count by setting the parameter alone.

The HIOEN/DHIOEN instruction is required to start/stop the count.

For the HIOEN/DHIOEN instruction, refer to  MELSEC iQ-F FX5 Programming Manual (Instructions, Standard Functions/Function Blocks).

Read/write of current value of high-speed counter

The current value of the high-speed counter is stored in a special register for each channel. You can check current value by monitoring the value. The value may however differ from the actual value because the special register is updated during END processing.

You can read the latest value using the HCMOV/DHCMOV instruction.

For details concerning special registers for high-speed counters, refer to  Page 264 Special registers list.

For information for the HCMOV/DHCMOV instruction, refer to  MELSEC iQ-F FX5 Programming Manual (Instructions, Standard Functions/Function Blocks).

Precautions

- Input used varies according to channel selected and pulse input mode.
- If not using preset input or enable input, you can use it as input for other functions.
- If mode is other than normal mode, preset input cannot be used.
- Use the HIOEN/DHIOEN instruction to start high-speed counter measurement.
- There are common precautions when using high-speed counters. For details, refer to  Page 286 Precautions when using high-speed counters.

High-speed counter (pulse density measurement mode)

The pulse density measurement mode for high-speed counters is explained below. The pulse density measurement mode is not supported in high-speed pulse input/output modules.

When in pulse density measurement mode, pulse is counted from count input of the high-speed counter, and the number of pulses for a specified amount of time is automatically counted.

Parameter setting

Set operation mode to pulse density measurement mode by high-speed counter parameter setting.

Sets detailed settings for channel used.

 Navigation window ⇒ [Parameter] ⇒ [FX5UJCPU] or [FX5UCPU] ⇒ [Module Parameter] ⇒ [High Speed I/O] ⇒ "Input Function" ⇒ "High Speed counter" ⇒ "Detail Setting" ⇒ "Basic Settings"

Window



Item	CH1	CH2	CH3
<input type="checkbox"/> Use/Do Not Use Counter	Set whether to use counter or not.		
Use/Not Use	Enable	Enable	Enable
<input type="checkbox"/> Operation Mode	Set operation mode.		
Operation Mode	Pulse Density Measurement Mode	Pulse Density Measurement Mode	Pulse Density Measurement Mode
<input type="checkbox"/> Pulse Input Mode	Set pulse input mode.		
Pulse Input Mode	1-Phase 1 Input (S/W Up/Down Switch)	1-Phase 1 Input (H/W Up/Down Switch)	2 Phase 2 Multiple
<input type="checkbox"/> Preset Input	Set preset input.		
Preset Input Enable/Disable	Disable	Disable	Disable
Input logic	Positive Logic	Positive Logic	Positive Logic
Input Comparison Enable/Disable	Disable	Disable	Disable
Control Switch	Rising	Rising	Rising
<input type="checkbox"/> Preset Value			
Preset Value	0	0	0
<input type="checkbox"/> Enable Input	Set enable input.		
Enable Input Enable/Disable	Disable	Disable	Disable
Input logic	Positive Logic	Positive Logic	Positive Logic
<input type="checkbox"/> Ring Length Setting	Set ring length.		
Ring Length Enable/Disable	Disable	Disable	Disable
Ring Length			
<input type="checkbox"/> Measurement Unit Time	Set the measurement unit time (ms) for the pulse density measurement mode and rotation speed measurement mode.		
Measurement Unit Time	1000	2000	30000
<input type="checkbox"/> No. of Pulse per Rotation	Set the number of pulses per rotation when using the rotation speed measurement mode.		
No. of Pulse per Rotation			

Displayed items

Item	Description	Setting range	Default
Use/Not Use	Set whether use counter or not.	<ul style="list-style-type: none"> • Disable • Enable 	Disable
Operation Mode	Set operation mode.	<ul style="list-style-type: none"> • Normal Mode • Pulse Density Assumption Mode • Rotation Speed Measurement Mode 	—
Pulse Input Mode	Set pulse input mode.	<ul style="list-style-type: none"> • 1-Phase 1 Input (S/W Up/Down Switch) • 1-Phase 1 Input (H/W Up/Down Switch) • 1 Phase 2 Input • 2 Phase 1 Multiple • 2 Phase 2 Multiple • 2 Phase 4 Multiple • Internal Clock (1MHz) 	—
Preset Input Enable/Disable	Not available for high-speed counters (pulse density measurement mode).	—	—
Input logic			
Input Comparison Enable/Disable			
Control Switch			
Preset Value			
Enable Input Enable/Disable	Set whether to "enable" or "disable" the enable input.	<ul style="list-style-type: none"> • Disable • Enable 	—
Input logic	Set the enable input logic value.	<ul style="list-style-type: none"> • Positive Logic • Negative Logic 	—
Ring Length Enable/Disable	Not available for high-speed counters (pulse density measurement mode).	—	—
Ring Length			
Measurement Unit Time	Set measurement unit time. (Unit: ms)	1 to 2147483647	—
No. of Pulse per Rotation	Not available for high-speed counters (pulse density measurement mode).	—	—

Point

Parameters are enabled when the CPU module is powered ON or after a reset. In addition, operations different from the parameter settings are possible by transferring values to special relays and special registers while changing these values in the program.

For details concerning special relays and special registers for high-speed counters, refer to  Page 250 Special relay list,  Page 264 Special registers list.

Pulse density measurement mode start/stop

The pulse density measurement mode cannot measure by setting the parameter alone.

The HIOEN/DHIOEN instruction is required to start/stop measurement.

For the HIOEN/DHIOEN instruction, refer to  MELSEC iQ-F FX5 Programming Manual (Instructions, Standard Functions/Function Blocks).

Pulse density

Pulse density is stored in the special register for each channel.

For details concerning special registers for high-speed counters, refer to [Page 264 Special registers list](#).

Precautions

Count direction switch during measurement

The pulse density measurement mode calculates pulse density based on difference in measuring unit time of the current value of high-speed counters. You should therefore note that the input number of pulses may differ from the measurement value when count direction of a high-speed counter is switched within the same measuring unit time.

Ex.

When pulse density is measured, 14 pulses are input within measuring unit time, but the current value of the high-speed counter remains "0", as shown in the following figure. As a result, pulse density is "0" for this measuring unit time.

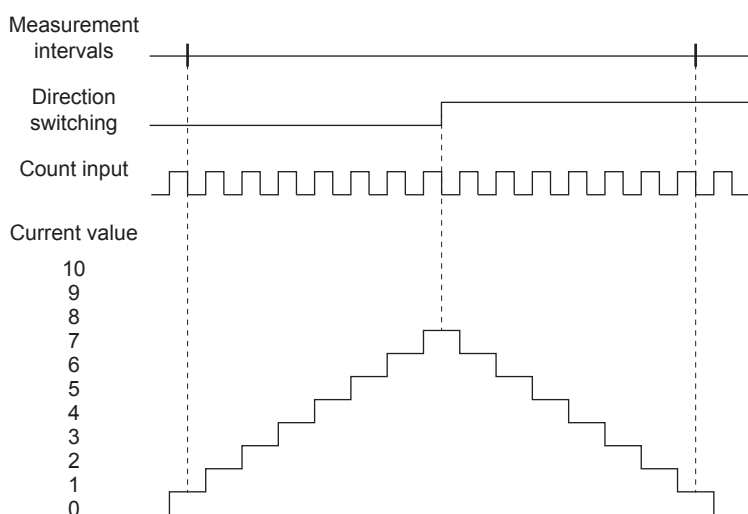

Operation when counting in the minus direction

Pulse density can also be measured when pulses are input in the direction whereby current value of high-speed counter is reduced.

Operation at overflow of high-speed counter current value

Pulse density measurement can continue even when current value of high-speed counter overflows during measurement.

Relationship with the SPD/DSPD instruction

If pulse density measurement has already been started by the HIOEN/DHIOEN instruction, the SPD/DSPD instruction cannot be used for the same channel.

If pulse density is currently being measured by the SPD/DSPD instruction, pulse density measurement cannot be started for the same channel.

For details on the SPD/DSPD instruction, refer to [MELSEC iQ-F FX5 Programming Manual \(Instructions, Standard Functions/Function Blocks\)](#).

Other precautions

There are common precautions when using high-speed counters. For details, refer to [Page 286 Precautions when using high-speed counters](#).

High-speed counter (rotational speed measurement mode)

The rotational speed measurement mode for high-speed counters is explained below. The rotational speed measurement mode is not supported in high-speed pulse input/output modules.

When in rotational speed measurement mode, pulse is counted from count input of the high-speed counter, and the rotational speed for a specified amount of time is automatically calculated.

Parameter setting

Set operation mode to rotational speed measurement mode by high-speed counter parameter setting.

Sets detailed settings for channel used.

Navigation window ⇒ [Parameter] ⇒ [FX5UJCPU] or [FX5UCPU] ⇒ [Module Parameter] ⇒ [High Speed I/O] ⇒ "Input Function" ⇒ "High Speed Counter" ⇒ "Detail Setting" ⇒ "Basic Setting"

Window

Item	CH1	CH2	CH3
Use/Do Not Use Counter	Set whether to use counter or not.		
Use/Not Use	Enable	Enable	Enable
Operation Mode	Set operation mode.		
Operation Mode	Rotation Speed Measurement Mode	Rotation Speed Measurement Mode	Rotation Speed Measurement Mode
Pulse Input Mode	Set pulse input mode.		
Pulse Input Mode	1-Phase 1 Input (S/W Up/Down Switch)	2 Phase 2 Multiple	2 Phase 4 Multiple
Preset Input	Set preset input.		
Preset Input Enable/Disable	Disable	Disable	Disable
Input logic	Positive Logic	Positive Logic	Positive Logic
Input Comparison Enable/Disable	Disable	Disable	Disable
Control Switch	Rising	Rising	Rising
Preset Value			
Preset Value	0	0	0
Enable Input	Set enable input.		
Enable Input Enable/Disable	Disable	Disable	Disable
Input logic	Positive Logic	Positive Logic	Positive Logic
Ring Length Setting	Set ring length.		
Ring Length Enable/Disable	Disable	Disable	Disable
Ring Length			
Measurement Unit Time	Set the measurement unit time (ms) for the pulse density measurement mode and rotation speed measurement mode.		
Measurement Unit Time	1000	3000	20000
No. of Pulse per Rotation	Set the number of pulses per rotation when using the rotation speed measurement mode.		
No. of Pulse per Rotation	1000	10000	15000

Displayed items

Item	Description	Setting range	Default
Use/Not Use	Set whether use counter or not.	<ul style="list-style-type: none"> Disable Enable 	Disable
Operation Mode	Set operation mode.	<ul style="list-style-type: none"> Normal Mode Pulse Density Assumption Mode Rotation Speed Measurement Mode 	—
Pulse Input Mode	Set pulse input mode.	<ul style="list-style-type: none"> 1-Phase 1 Input (S/W Up/Down Switch) 1-Phase 1 Input (H/W Up/Down Switch) 1 Phase 2 Input 2 Phase 1 Multiple 2 Phase 2 Multiple 2 Phase 4 Multiple Internal Clock (1MHz) 	—

Item	Description	Setting range	Default
Preset Input Enable/ Disable	Not available for high-speed counters (rotational speed measurement mode).	—	—
Input logic			
Input Comparison Enable/ Disable			
Control Switch			
Preset Value			
Enable Input Enable/ Disable	Set whether to "enable" or "disable" the enable input.	<ul style="list-style-type: none"> • Disable • Enable 	—
Input logic	Set the enable input logic value.	<ul style="list-style-type: none"> • Positive Logic • Negative Logic 	—
Ring Length Enable/ Disable	Not available for high-speed counters (rotational speed measurement mode).	—	—
Ring Length			
Measurement Unit Time	Set measurement unit time. (Unit: ms)	1 to 2147483647	—
No. of Pulse per Rotation	Set the No. of pulses per rotation. (Unit: pulse)	1 to 2147483647	—

Point

Parameters are enabled when the CPU module is powered ON or after a reset. In addition, operations different from the parameter settings are possible by transferring values to special relays and special registers while changing these values in the program.

For details concerning special relays and special registers for high-speed counters, refer to [Page 250](#) Special relay list, [Page 264](#) Special registers list.

Rotational speed measurement mode start/stop

The rotational speed measurement mode cannot measure by setting the parameter alone.

The HIOEN/DHIOEN instruction is required to start/stop measurement.

For the HIOEN/DHIOEN instruction, refer to [MELSEC iQ-F FX5 Programming Manual \(Instructions, Standard Functions/Function Blocks\)](#).

Rotational speed

Rotational speed is stored in the special register for each channel. (Unit: r/min)

For details concerning special registers for high-speed counters, refer to [Page 264](#) Special registers list.

Precautions

■Count direction switch during measurement

The rotational speed measurement mode calculates rotational speed based on current value difference of high-speed counters in the measuring unit time. You should therefore note that the input number of pulses may differ from the measurement value when count direction of a high-speed counter is switched within the same measuring unit time.

■Operation when counting in the minus direction

Rotational speed can also be measured when pulses are input in the direction whereby current value of high-speed counter is reduced.

■Operation at overflow of high-speed counter current value

Rotational speed measurement can continue even when current value of high-speed counter overflows during measurement.

■Relationship with the SPD/DSPD instruction

If rotational speed measurement has already been started by the HIOEN/DHIOEN instruction, the SPD/DSPD instruction cannot be used for the same channel.

Inversely, if pulse density is currently being measured by the SPD/DSPD instruction, rotational speed measurement cannot be started for the same channel.

For details on the SPD/DSPD instruction, refer to [MELSEC iQ-F FX5 Programming Manual \(Instructions, Standard Functions/Function Blocks\)](#).

Other precautions

There are common precautions when using high-speed counters. For details, refer to  Page 286 Precautions when using high-speed counters.

High-speed comparison table

The high-speed comparison table is explained below.

Used to set high-speed comparison table for high-speed counters.

Parameter setting

Sets match output setting for high-speed counters.

CPU module

 Navigation window ⇒ [Parameter] ⇒ [FX5UJCPU] or [FX5UCPU] ⇒ [Module Parameter] ⇒ [High Speed I/O] ⇒ "Input Function" ⇒ "High Speed Counter" ⇒ "Detail Setting" ⇒ "High Speed Compare Table"

Window

NO.	Counter CH	Comparison Type	Output Destination Device	Comparison Value 1 Specification Method	Comparison Value 1 Direct	Comparison Value 1 Indirect	Comparison Value 2 Specification Method	Comparison Value 2 Direct	Comparison Value 2 Indirect
1	CH1	Set	Y0	Direct Specification	100		Direct Specification	0	
2	CH2	Set	Y1	Indirect Specification	0	D101	Direct Specification	0	
3	CH3	Band Area Comparis	Y2	Direct Specification	200		Direct Specification	300	
4	CH4	Band Area Comparis	Y3	Indirect Specification	0	D103	Indirect Specification	0	D105
5	Disable	Set		Direct Specification	0		Direct Specification	0	

Displayed items

Item	Description	Setting range	Default
Counter CH	Set the counter CH of coincidence output target.	Disable, CH1 to CH8	Disable
Comparison Type	Set comparison type.	<ul style="list-style-type: none"> Set Reset Self Reset Band Area Comparison 	Set
Output Destination Device	Sets output destination device for output comparison results of comparison value 1 and comparison value 2.	Bit device (Y, M), Interrupt pointer (I16 to I23)	—
Comparison Value 1 Specification Method	Sets the specification method of comparison value 1.	<ul style="list-style-type: none"> Direct Specification Indirect Specification 	Direct Specification
Comparison Value 1 Direct	Sets value (comparison value 1) to be compared with current value of high-speed counter. (When direct specification is selected)	$-2147483648 \leq \text{Comparison value 1} \leq 2147483647$	0
Comparison Value 1 Indirect	Sets device (comparison value 1) to be compared with current value of high-speed counter. (When indirect specification is selected)	Word device (D, R)	—
Comparison Value 2 Specification Method	If band comparison is set to comparison type, sets the specification method of comparison value 2.	<ul style="list-style-type: none"> Direct Specification Indirect Specification 	—
Comparison Value 2 Direct	If band comparison is set to comparison type, sets value (comparison value 2) to be compared with current value of high-speed counter. (When direct specification is selected)	$\text{Comparison value 1} \leq \text{Comparison value 2} \leq 2147483647$	—
Comparison Value 2 Indirect	If band comparison is set to comparison type, sets device (comparison value 2) to be compared with current value of high-speed counter. (When indirect specification is selected)	Word device (D, R)	—

High-speed pulse input/output module

Add the high-speed pulse input/output module.

Navigation window ⇒ [Parameter] ⇒ [Module Information] ⇒ Right-click ⇒ Add New Module

After adding the high-speed pulse input/output module, make settings on the the screen displayed from the following operation.

Navigation window ⇒ [Parameter] ⇒ [Module Information] ⇒ [1 to 16 (high-speed pulse input/output module)] ⇒ [Module Parameter] ⇒ "Input Function" ⇒ "High Speed Counter" ⇒ "Detailed Setting" ⇒ "High Speed Compare Table"

Window

NO.	Counter CH	Comparison Type	Output Destination Device	Comparison Value 1 Specification Method	Comparison Value 1 Direct	Comparison Value 1 Indirect
1	CH+0(CH9)	Set	Y0	Direct Specification	100	
2	CH+1(CH10)	Reset	Y1	Indirect Specification	0	D100
3	Disable	Set		Direct Specification	0	

Shown above is the screen at the time when the first high-speed pulse input/output module is selected.

Displayed items

Item	Description	Setting range	Default
Counter CH	Set the counter CH of coincidence output target.	Disable, CH+0(CH□),CH+1(CH□+1) ^{*1}	Disable
Comparison Type	Set comparison type.	<ul style="list-style-type: none"> Set Reset Self Reset 	Set
Output Destination Device	Sets output destination device for output comparison results of comparison value 1 and comparison value 2.	Bit device (Y, M), Interrupt pointer (I50 to I177)	—
Comparison Value 1 Specification Method	Sets the specification method of comparison value 1.	<ul style="list-style-type: none"> Direct Specification Indirect Specification 	Direct Specification
Comparison Value 1 Direct	Sets value (comparison value 1) to be compared with current value of high-speed counter. (When direct specification is selected)	-2147483648≤Comparison value 1≤2147483647	0
Comparison Value 1 Indirect	Sets device (comparison value 1) to be compared with current value of high-speed counter. (When indirect specification is selected)	Word device (D, R)	—

*1 The number in □ is first module: 9, second module: 11, third module: 13, fourth module: 15.

Point

- You can create an open table entry before table setting is complete.
- Table settings can be made in any order. Be careful when the current value is changed by self-reset at a table along the way, as table processing starts with the first table then the following tables in order.

High-speed comparison table operation

Operation of each type of high-speed comparison table operation is explained below.

Set to ON

When comparison value 1 matches the current value of the set high-speed counter, the bit device specified as the output destination device is set. If interrupt pointer has been specified for output destination device, the interrupt program of the specified interrupt pointer is run simultaneously when it matches comparison value 1.

Operation is the same as for the DHSCS instruction. For information on the DHSCS instruction, refer to MELSEC iQ-F FX5 Programming Manual (Instructions, Standard Functions/Function Blocks).

Reset

When comparison value 1 matches the current value of the set high-speed counter, the bit device specified as the output destination device is reset.

Operation is the same as for the DHSCR instruction. For information on the DHSCR instruction, refer to MELSEC iQ-F FX5 Programming Manual (Instructions, Standard Functions/Function Blocks).

■Self-reset

When comparison value 1 matches the current value of the set high-speed counter, the current value becomes the preset value. After comparison processing is executed for this table, comparison processing of this high speed counter in later tables is performed using the preset value.

Operation is the same as self-reset for the DHSCR instruction. For information on the DHSCR instruction, refer to  MELSEC iQ-F FX5 Programming Manual (Instructions, Standard Functions/Function Blocks).

■Zone Compare

Based on the current high-speed counter value, comparison value 1, and comparison value 3, one of the three output devices from the head output device will be set. The rest are reset. High-speed pulse input/output module is not supported.

	Set
Comparison value 1 > Current value	→ Head output device
Comparison value 1 ≤ Current value ≤ Comparison value 2	→ Head output device +1
Current value > Comparison value 2	→ Head output device +2

Operation is the same as for the DHSZ instruction. For information on zone comparison and DHSZ instruction, refer to  MELSEC iQ-F FX5 Programming Manual (Instructions, Standard Functions/Function Blocks).

Comparison start/stop for high-speed comparison table

High-speed comparison tables cannot execute comparison by setting the parameter alone.

The HIOEN/DHIOEN instruction is required to start/stop the high-speed comparison table.

For the HIOEN/DHIOEN instruction, refer to  MELSEC iQ-F FX5 Programming Manual (Instructions, Standard Functions/Function Blocks).

Point

The HIOEN/DHIOEN instruction is required to start/stop high-speed counters as well when using a high-speed comparison table.

Measurement is not conducted by starting the high-speed comparison table alone, and the high-speed comparison table therefore does not operate.

When the number of the high-speed comparison table that is executed is number 17 or higher, use the DHIOEN instruction.

Precautions

■Number of tables that can be set

Up to 32 tables for the CPU module and up to 15 tables for the high-speed pulse input/output module can be set. Empty tables are not included in the number of tables.

However, number of tables that can be set differs depending on the version. ( Page 566 Added and Enhanced Functions)

■Processing order

High-speed comparison tables are processed in sequence starting from the first table.

■Operation start timing

High-speed comparison tables are updated during END processing. If started/stopped by the HIOEN/DHIOEN instruction, the table is applied starting from the next scan. Caution must be exercised when controlling high-speed comparison tables using the HIOEN/DHIOEN instruction several times within the same scan.

Ex.

Table operation is as follows when multiple HIOEN/DHIOEN instructions are executed within the same scan.
 Tables 1, 2 and 4 are started at the 1st HIOEN/DHIOEN instruction.
 Tables 3 and 5 are started, and 2 and 4 are stopped at the 2nd HIOEN/DHIOEN instruction.
 Table 2 is started and 5 is stopped at the 3rd HIOEN/DHIOEN instruction.
 Tables 1, 2 and 3 operate.

■Operation when using internal clock

Self-reset cannot be used for channels set to internal clock by pulse input mode.

■Other precautions

There are common precautions when using high-speed counters. For details, refer to  Page 286 Precautions when using high-speed counters.

Multiple point output, high-speed comparison tables

Multiple point output, high-speed comparison tables are explained below. The multiple point output, high-speed comparison tables is not supported in high-speed pulse input/output modules.

Use to set multiple point output, high-speed comparison tables for high-speed counters.

Sets match output table comparison setting for high-speed counters.

Parameter setting

 Navigation window ⇒ [Parameter] ⇒ [FX5UJCPU] or [FX5UCPU] ⇒ [Module Parameter] ⇒ [High Speed I/O] ⇒ "Input Function" ⇒ "High Speed counter" ⇒ "Detail Setting" ⇒ "Multi-point Output High Speed Compare Table"

Window

Table Data	Use Device	Counter CH	CH1		
Output Data	Bit Output	Points	1		
NO.	Enable/Disable	Device	Comparison Value	Output Device	Output Data (HEX)
1	Enable	D100	100	Y0	1
2	Enable	D104	200	Y0	0
3	Disable	D108	0	Y0	

Displayed items

Item	Description	Setting range	Default
Table Data	Sets whether or not to use user device for table data.	<ul style="list-style-type: none"> Do Not Use Device Use Device 	Do Not Use Device
Counter CH	Set Comparison Target CH.	CH1 to CH8	CH1
Output Data	Sets the type of output data.	<ul style="list-style-type: none"> Bit Output Word Output 	Bit Output
Points	Sets the number of output data points.	<ul style="list-style-type: none"> Bit Output 1 to 16 Word Output 1 to 2 	1
Enable/Disable	Sets whether to "enable" or "disable" table data.	<ul style="list-style-type: none"> Disable Enable 	Disable
Device	Set the device used for table data.	Word device (D, R)	—
Comparison Value	Sets value (comparison value) to be compared with current value of high-speed counter.	-2147483648≤Comparison value≤+2147483647	—
Output Device	Sets the output destination device of output data.	<ul style="list-style-type: none"> Bit Output Y, M Word Output D, R 	—
Output Data (HEX)	Sets output data.	According to output device	—

- When using user devices, you can change comparison value or output data while the program is running.
- When using user devices, each table occupies 4 devices. Word devices are used in order starting from the initial device.

Multiple point output, high-speed comparison table operation

Operation of each type high-speed comparison table is explained below.

■Bit output

When comparison value 1 matches the current value of the set high-speed counter, output data is transferred to the output devices.

Ex.

Bit output, initial output device: Y0, Output points: 16

Table number	Comparison value	Output data
Table 1	10	H0001
Table 2	13	HAAAA
Table 3	19	H0100

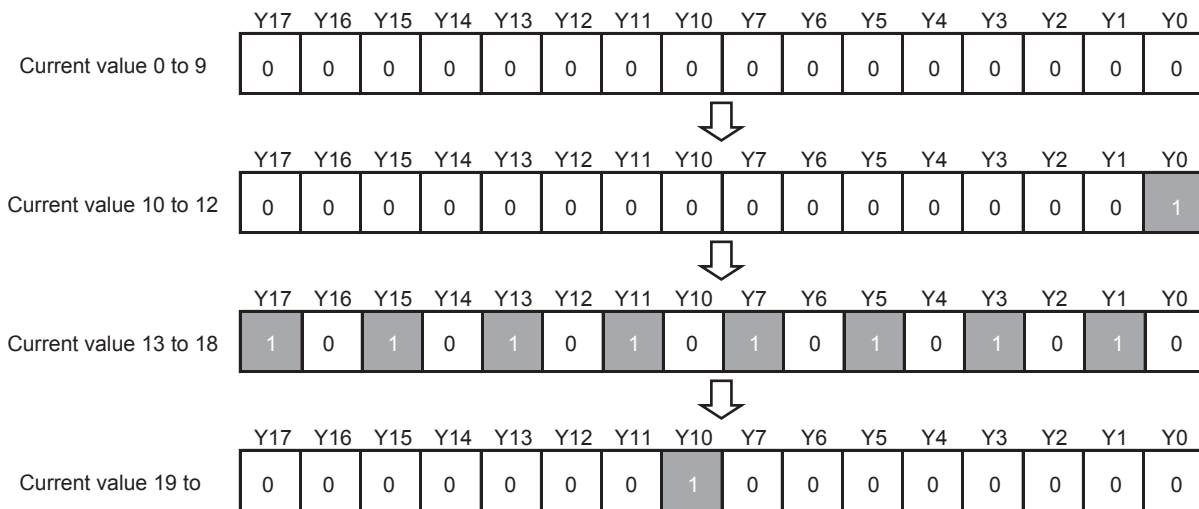

■Word output

When comparison value 1 matches the current value of the set high-speed counter, output data is transferred to the output devices.

Ex.

Word output, initial output device: D0, Output points: 1

Table number	Comparison value	Output data
Table 1	10	K100
Table 2	13	K300
Table 3	19	K10

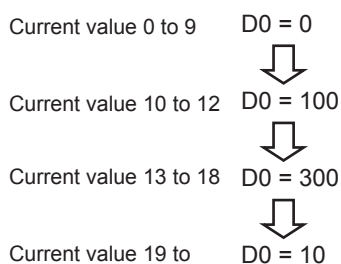

Comparison start/stop for multiple point output, high-speed comparison table

Multiple point output, high-speed comparison tables cannot execute comparison by setting the parameter alone. The HIOEN/DHIOEN instruction is required to start/stop multiple point output, high-speed comparison tables. For the HIOEN/DHIOEN instruction, refer to  MELSEC iQ-F FX5 Programming Manual (Instructions, Standard Functions/Function Blocks).

Point

The HIOEN/DHIOEN instruction is required to start/stop high-speed counters as well when using a multiple point output, high-speed comparison table. Measurement is not conducted by starting the multiple point output, high-speed comparison table alone, and the high-speed comparison table therefore does not operate.

Precautions

■Setting number

Up to 128 tables can be set.

■Device value when using user device

Parameters and user devices are handled as follows when using user devices.

Ex.

If D0 is set to initial device

Table number	User device	
	Comparison value	Output data
Table 1	D1, D0	D3, D2
Table 2	D5, D4	D7, D6
Table 3	D9, D8	D11, D10
Table 4	D13, D12	D15, D14
Table 5	D17, D16	D19, D18

■When final table comparison is complete

When comparison processing has been completed up to the last set table, SM5001 turns ON. The high-speed counter current value is not cleared.

■Operation start timing

Multiple point output, high-speed comparison tables are enabled as soon as the HIOEN/DHIOEN instruction is executed.

■Table operation interval

The comparison value or input frequency must be set so the comparison value and high-speed counter current value match at intervals of following value.

- FX5UJ CPU module: 200 μ s or more for each table
- FX5U/FX5UC CPU module: 100 μ s or more for each table

■Processing order

Multiple point output, high-speed comparison tables are processed in sequence starting from the first table. Only 1 table per count is processed.

■Table setting value update timing

When using user devices, you can change the table setting values by modifying the values of the device. However, the comparison value and output data values of the table currently being compared and the next table cannot be changed. If you modify the comparison values or output data, you can modify data of the next table in the sequence and those subsequent. The table number of which the table is being currently compared can be checked in the special register (SD5000).

■Other precautions

There are common precautions when using high-speed counters. For details, refer to  Page 286 Precautions when using high-speed counters.

Special relay list

A list of special relays used for high-speed counters is provided below.

Special relays for individual channels

A list of special relays by high-speed counter channel is provided below.

○: Supported, ×: Not supported

R: Read only, R/W: Read or Write

Special relay	Function	Operation		Default	Function support		R/W
		ON	OFF		FX5UJ	FX5U/ FX5UC	
SM4500	High-speed counter operation (CH1)	Operating	Stopped	OFF	○	○	R
SM4501	High-speed counter operation (CH2)				○	○	
SM4502	High-speed counter operation (CH3)				○	○	
SM4503	High-speed counter operation (CH4)				○	○	
SM4504	High-speed counter operation (CH5)				○	○	
SM4505	High-speed counter operation (CH6)				○	○	
SM4506	High-speed counter operation (CH7)				○	○	
SM4507	High-speed counter operation (CH8)				○	○	
SM4508	High-speed counter operation (CH9)				×	○	
SM4509	High-speed counter operation (CH10)				×	○	
SM4510	High-speed counter operation (CH11)				×	○	
SM4511	High-speed counter operation (CH12)				×	○	
SM4512	High-speed counter operation (CH13)				×	○	
SM4513	High-speed counter operation (CH14)				×	○	
SM4514	High-speed counter operation (CH15)				×	○	
SM4515	High-speed counter operation (CH16)				×	○	
SM4516	High-speed counter pulse density/Rotation speed measurement (CH1)	Measuring	Stopped	OFF	○	○	R
SM4517	High-speed counter pulse density/Rotation speed measurement (CH2)				○	○	
SM4518	High-speed counter pulse density/Rotation speed measurement (CH3)				○	○	
SM4519	High-speed counter pulse density/Rotation speed measurement (CH4)				○	○	
SM4520	High-speed counter pulse density/Rotation speed measurement (CH5)				○	○	
SM4521	High-speed counter pulse density/Rotation speed measurement (CH6)				○	○	
SM4522	High-speed counter pulse density/Rotation speed measurement (CH7)				○	○	
SM4523	High-speed counter pulse density/Rotation speed measurement (CH8)				○	○	
SM4524 to SM4531	Not used	—	—	—	—	—	—
SM4532	High-speed counter overflow (CH1)	Has occurred	Has not occurred	OFF	○	○	R/W
SM4533	High-speed counter overflow (CH2)				○	○	
SM4534	High-speed counter overflow (CH3)				○	○	
SM4535	High-speed counter overflow (CH4)				○	○	
SM4536	High-speed counter overflow (CH5)				○	○	
SM4537	High-speed counter overflow (CH6)				○	○	
SM4538	High-speed counter overflow (CH7)				○	○	
SM4539	High-speed counter overflow (CH8)				○	○	
SM4540	High-speed counter overflow (CH9)				×	○	
SM4541	High-speed counter overflow (CH10)				×	○	
SM4542	High-speed counter overflow (CH11)				×	○	
SM4543	High-speed counter overflow (CH12)				×	○	
SM4544	High-speed counter overflow (CH13)				×	○	
SM4545	High-speed counter overflow (CH14)				×	○	
SM4546	High-speed counter overflow (CH15)				×	○	
SM4547	High-speed counter overflow (CH16)				×	○	

Special relay	Function	Operation		Default	Function support		R/W
		ON	OFF		FX5UJ	FX5U/ FX5UC	
SM4548	High-speed counter underflow (CH1)	Has occurred	Has not occurred	OFF	○	○	R/W
SM4549	High-speed counter underflow (CH2)				○	○	
SM4550	High-speed counter underflow (CH3)				○	○	
SM4551	High-speed counter underflow (CH4)				○	○	
SM4552	High-speed counter underflow (CH5)				○	○	
SM4553	High-speed counter underflow (CH6)				○	○	
SM4554	High-speed counter underflow (CH7)				○	○	
SM4555	High-speed counter underflow (CH8)				○	○	
SM4556	High-speed counter underflow (CH9)				×	○	
SM4557	High-speed counter underflow (CH10)				×	○	
SM4558	High-speed counter underflow (CH11)				×	○	
SM4559	High-speed counter underflow (CH12)				×	○	
SM4560	High-speed counter underflow (CH13)				×	○	
SM4561	High-speed counter underflow (CH14)				×	○	
SM4562	High-speed counter underflow (CH15)				×	○	
SM4563	High-speed counter underflow (CH16)				×	○	
SM4564	High-speed counter count direction monitor (CH1)	Down-counting	Up-counting	OFF	○	○	R
SM4565	High-speed counter count direction monitor (CH2)				○	○	
SM4566	High-speed counter count direction monitor (CH3)				○	○	
SM4567	High-speed counter count direction monitor (CH4)				○	○	
SM4568	High-speed counter count direction monitor (CH5)				○	○	
SM4569	High-speed counter count direction monitor (CH6)				○	○	
SM4570	High-speed counter count direction monitor (CH7)				○	○	
SM4571	High-speed counter count direction monitor (CH8)				○	○	
SM4572	High-speed counter count direction monitor (CH9)				×	○	
SM4573	High-speed counter count direction monitor (CH10)				×	○	
SM4574	High-speed counter count direction monitor (CH11)				×	○	
SM4575	High-speed counter count direction monitor (CH12)				×	○	
SM4576	High-speed counter count direction monitor (CH13)				×	○	
SM4577	High-speed counter count direction monitor (CH14)				×	○	
SM4578	High-speed counter count direction monitor (CH15)				×	○	
SM4579	High-speed counter count direction monitor (CH16)				×	○	

Special relay	Function	Operation		Default	Function support		R/W
		ON	OFF		FX5UJ	FX5U/ FX5UC	
SM4580	High-speed counter count direction switching (CH1) (1-phase 1-input S/W)	Down-counting	Up-counting	OFF	<input type="radio"/>	<input type="radio"/>	R/W
SM4581	High-speed counter count direction switching (CH2) (1-phase 1-input S/W)				<input type="radio"/>	<input type="radio"/>	
SM4582	High-speed counter count direction switching (CH3) (1-phase 1-input S/W)				<input type="radio"/>	<input type="radio"/>	
SM4583	High-speed counter count direction switching (CH4) (1-phase 1-input S/W)				<input type="radio"/>	<input type="radio"/>	
SM4584	High-speed counter count direction switching (CH5) (1-phase 1-input S/W)				<input type="radio"/>	<input type="radio"/>	
SM4585	High-speed counter count direction switching (CH6) (1-phase 1-input S/W)				<input type="radio"/>	<input type="radio"/>	
SM4586	High-speed counter count direction switching (CH7) (1-phase 1-input S/W)				<input type="radio"/>	<input type="radio"/>	
SM4587	High-speed counter count direction switching (CH8) (1-phase 1-input S/W)				<input type="radio"/>	<input type="radio"/>	
SM4588	High-speed counter count direction switching (CH9) (1-phase 1-input S/W)				<input checked="" type="radio"/>	<input type="radio"/>	
SM4589	High-speed counter count direction switching (CH10) (1-phase 1-input S/W)				<input checked="" type="radio"/>	<input type="radio"/>	
SM4590	High-speed counter count direction switching (CH11) (1-phase 1-input S/W)				<input checked="" type="radio"/>	<input type="radio"/>	
SM4591	High-speed counter count direction switching (CH12) (1-phase 1-input S/W)				<input checked="" type="radio"/>	<input type="radio"/>	
SM4592	High-speed counter count direction switching (CH13) (1-phase 1-input S/W)				<input checked="" type="radio"/>	<input type="radio"/>	
SM4593	High-speed counter count direction switching (CH14) (1-phase 1-input S/W)				<input checked="" type="radio"/>	<input type="radio"/>	
SM4594	High-speed counter count direction switching (CH15) (1-phase 1-input S/W)				<input checked="" type="radio"/>	<input type="radio"/>	
SM4595	High-speed counter count direction switching (CH16) (1-phase 1-input S/W)				<input checked="" type="radio"/>	<input type="radio"/>	
SM4596	High-speed counter preset input logic (CH1)	Negative logic	Positive logic	Parameter setting values	<input type="radio"/>	<input type="radio"/>	R/W
SM4597	High-speed counter preset input logic (CH2)				<input type="radio"/>	<input type="radio"/>	
SM4598	High-speed counter preset input logic (CH3)				<input type="radio"/>	<input type="radio"/>	
SM4599	High-speed counter preset input logic (CH4)				<input type="radio"/>	<input type="radio"/>	
SM4600	High-speed counter preset input logic (CH5)				<input type="radio"/>	<input type="radio"/>	
SM4601	High-speed counter preset input logic (CH6)				<input type="radio"/>	<input type="radio"/>	
SM4602	High-speed counter preset input logic (CH7)				<input type="radio"/>	<input type="radio"/>	
SM4603	High-speed counter preset input logic (CH8)				<input type="radio"/>	<input type="radio"/>	
SM4604	High-speed counter preset input logic (CH9)				<input checked="" type="radio"/>	<input type="radio"/>	
SM4605	High-speed counter preset input logic (CH10)				<input checked="" type="radio"/>	<input type="radio"/>	
SM4606	High-speed counter preset input logic (CH11)				<input checked="" type="radio"/>	<input type="radio"/>	
SM4607	High-speed counter preset input logic (CH12)				<input checked="" type="radio"/>	<input type="radio"/>	
SM4608	High-speed counter preset input logic (CH13)				<input checked="" type="radio"/>	<input type="radio"/>	
SM4609	High-speed counter preset input logic (CH14)				<input checked="" type="radio"/>	<input type="radio"/>	
SM4610	High-speed counter preset input logic (CH15)				<input checked="" type="radio"/>	<input type="radio"/>	
SM4611	High-speed counter preset input logic (CH16)				<input checked="" type="radio"/>	<input type="radio"/>	

Special relay	Function	Operation		Default	Function support		R/W
		ON	OFF		FX5UJ	FX5U/ FX5UC	
SM4612	High-speed counter preset input comparison (CH1)	Valid	Invalid	Parameter setting values	<input type="radio"/>	<input type="radio"/>	R/W
SM4613	High-speed counter preset input comparison (CH2)				<input type="radio"/>	<input type="radio"/>	
SM4614	High-speed counter preset input comparison (CH3)				<input type="radio"/>	<input type="radio"/>	
SM4615	High-speed counter preset input comparison (CH4)				<input type="radio"/>	<input type="radio"/>	
SM4616	High-speed counter preset input comparison (CH5)				<input type="radio"/>	<input type="radio"/>	
SM4617	High-speed counter preset input comparison (CH6)				<input type="radio"/>	<input type="radio"/>	
SM4618	High-speed counter preset input comparison (CH7)				<input type="radio"/>	<input type="radio"/>	
SM4619	High-speed counter preset input comparison (CH8)				<input type="radio"/>	<input type="radio"/>	
SM4620	High-speed counter preset input comparison (CH9)				<input checked="" type="radio"/>	<input type="radio"/>	
SM4621	High-speed counter preset input comparison (CH10)				<input checked="" type="radio"/>	<input type="radio"/>	
SM4622	High-speed counter preset input comparison (CH11)				<input checked="" type="radio"/>	<input type="radio"/>	
SM4623	High-speed counter preset input comparison (CH12)				<input checked="" type="radio"/>	<input type="radio"/>	
SM4624	High-speed counter preset input comparison (CH13)				<input checked="" type="radio"/>	<input type="radio"/>	
SM4625	High-speed counter preset input comparison (CH14)				<input checked="" type="radio"/>	<input type="radio"/>	
SM4626	High-speed counter preset input comparison (CH15)				<input checked="" type="radio"/>	<input type="radio"/>	
SM4627	High-speed counter preset input comparison (CH16)				<input checked="" type="radio"/>	<input type="radio"/>	
SM4628	High-speed counter enable input logic (CH1)	Negative logic	Positive logic	Parameter setting values	<input type="radio"/>	<input type="radio"/>	R/W
SM4629	High-speed counter enable input logic (CH2)				<input type="radio"/>	<input type="radio"/>	
SM4630	High-speed counter enable input logic (CH3)				<input type="radio"/>	<input type="radio"/>	
SM4631	High-speed counter enable input logic (CH4)				<input type="radio"/>	<input type="radio"/>	
SM4632	High-speed counter enable input logic (CH5)				<input type="radio"/>	<input type="radio"/>	
SM4633	High-speed counter enable input logic (CH6)				<input type="radio"/>	<input type="radio"/>	
SM4634	High-speed counter enable input logic (CH7)				<input type="radio"/>	<input type="radio"/>	
SM4635	High-speed counter enable input logic (CH8)				<input type="radio"/>	<input type="radio"/>	
SM4636	High-speed counter enable input logic (CH9)				<input checked="" type="radio"/>	<input type="radio"/>	
SM4637	High-speed counter enable input logic (CH10)				<input checked="" type="radio"/>	<input type="radio"/>	
SM4638	High-speed counter enable input logic (CH11)				<input checked="" type="radio"/>	<input type="radio"/>	
SM4639	High-speed counter enable input logic (CH12)				<input checked="" type="radio"/>	<input type="radio"/>	
SM4640	High-speed counter enable input logic (CH13)				<input checked="" type="radio"/>	<input type="radio"/>	
SM4641	High-speed counter enable input logic (CH14)				<input checked="" type="radio"/>	<input type="radio"/>	
SM4642	High-speed counter enable input logic (CH15)				<input checked="" type="radio"/>	<input type="radio"/>	
SM4643	High-speed counter enable input logic (CH16)				<input checked="" type="radio"/>	<input type="radio"/>	
SM4644	High-speed counter ring length setting (CH1)	Valid	Invalid	Parameter setting values	<input type="radio"/>	<input type="radio"/>	R/W
SM4645	High-speed counter ring length setting (CH2)				<input type="radio"/>	<input type="radio"/>	
SM4646	High-speed counter ring length setting (CH3)				<input type="radio"/>	<input type="radio"/>	
SM4647	High-speed counter ring length setting (CH4)				<input type="radio"/>	<input type="radio"/>	
SM4648	High-speed counter ring length setting (CH5)				<input type="radio"/>	<input type="radio"/>	
SM4649	High-speed counter ring length setting (CH6)				<input type="radio"/>	<input type="radio"/>	
SM4650	High-speed counter ring length setting (CH7)				<input type="radio"/>	<input type="radio"/>	
SM4651	High-speed counter ring length setting (CH8)				<input type="radio"/>	<input type="radio"/>	
SM4652	High-speed counter ring length setting (CH9)				<input checked="" type="radio"/>	<input type="radio"/>	
SM4653	High-speed counter ring length setting (CH10)				<input checked="" type="radio"/>	<input type="radio"/>	
SM4654	High-speed counter ring length setting (CH11)				<input checked="" type="radio"/>	<input type="radio"/>	
SM4655	High-speed counter ring length setting (CH12)				<input checked="" type="radio"/>	<input type="radio"/>	
SM4656	High-speed counter ring length setting (CH13)				<input checked="" type="radio"/>	<input type="radio"/>	
SM4657	High-speed counter ring length setting (CH14)				<input checked="" type="radio"/>	<input type="radio"/>	
SM4658	High-speed counter ring length setting (CH15)				<input checked="" type="radio"/>	<input type="radio"/>	
SM4659	High-speed counter ring length setting (CH16)				<input checked="" type="radio"/>	<input type="radio"/>	

Special relays shared by all channels

A list of shared special relays is provided below.

○: Supported, ×: Not supported

R: Read only, R/W: Read or Write

Special relay	Function	Operation		Default	Function support		R/W
		ON	OFF		FX5UJ	FX5U/ FX5UC	
SM4980	High-speed comparison table (high-speed compare instruction) operation (CPU module)	Operating	Stopped	OFF	○	○	R
SM4982	High-speed comparison table (high-speed compare instruction) error occurrence (CPU module)	Has occurred	Has not occurred	OFF	○	○	R/W
SM4984	High-speed comparison table operation (high-speed pulse input/output module first module)	Operating	Stopped	OFF	×	○	R
SM4986	High-speed comparison table error occurrence (high-speed pulse input/output module first module)	Has occurred	Has not occurred	OFF	×	○	R/W
SM4988	High-speed comparison table operation (high-speed pulse input/output module second module)	Operating	Stopped	OFF	×	○	R
SM4990	High-speed comparison table error occurrence (high-speed pulse input/output module second module)	Has occurred	Has not occurred	OFF	×	○	R/W
SM4992	High-speed comparison table operation (high-speed pulse input/output module third module)	Operating	Stopped	OFF	×	○	R
SM4994	High-speed comparison table error occurrence (high-speed pulse input/output module third module)	Has occurred	Has not occurred	OFF	×	○	R/W
SM4996	High-speed comparison table operation (high-speed pulse input/output module fourth module)	Operating	Stopped	OFF	×	○	R
SM4998	High-speed comparison table error occurrence (high-speed pulse input/output module fourth module)	Has occurred	Has not occurred	OFF	×	○	R/W
SM5000	Multi-point output high-speed comparison table operation	Operating	Stopped	OFF	○	○	R
SM5001	Multi-point output high-speed comparison table completion	Complete	Not complete	OFF	○	○	R/W

Special relay details

Details concerning special relays used for high-speed counters are explained below.

High-speed counter operating

Device for monitoring operation status of each channel of the high-speed counter.

■Corresponding devices

The device numbers corresponding to each channel are as follows.

CPU module							
CH1	CH2	CH3	CH4	CH5	CH6	CH7	CH8
SM4500	SM4501	SM4502	SM4503	SM4504	SM4505	SM4506	SM4507

High-speed pulse input/output module							
First module		Second module		Third module		Fourth module	
CH9	CH10	CH11	CH12	CH13	CH14	CH15	CH16
SM4508	SM4509	SM4510	SM4511	SM4512	SM4513	SM4514	SM4515

■Operation Description

The content of the operation when ON and when OFF is as follows.

Operation when ON	Operation when OFF
High-speed counter operating	High-speed counter stopped



These devices also operate when the FX3 compatible high-speed counter function is valid.

■Update timing

The timing of device update is as follows.

ON	OFF
<ul style="list-style-type: none"> High-speed counter driven by the HIOEN/DHIOEN instruction SPD/DSPD instruction ON execution UDCNTF instruction is executed ON (when the FX3 compatible high-speed counter function is valid) 	<ul style="list-style-type: none"> High-speed counter stopped by the HIOEN/DHIOEN instruction Power ON, reset, STOP, PAUSE UDCNTF instruction is executed OFF (when the FX3 compatible high-speed counter function is valid)

High-speed counter pulse density/rotational speed being measured

Device for monitoring operation of the high-speed counter when using pulse density/rotational speed measurement mode.

■Corresponding devices

The device numbers corresponding to each channel are as follows.

CH1	CH2	CH3	CH4	CH5	CH6	CH7	CH8
SM4516	SM4517	SM4518	SM4519	SM4520	SM4521	SM4522	SM4523

■Operation Description

The content of the operation when ON and when OFF is as follows.

Operation when ON	Operation when OFF
Pulse density/rotational speed measurement mode operating Updates measurement results by measuring unit time.	Pulse density/rotational speed measurement mode stopped or not being used



If the FX3 compatible high-speed counter function is valid, these devices operate only when the SPD/DSPD instruction operates.

Update timing

The timing of device update is as follows.

ON	OFF
<ul style="list-style-type: none"> Pulse density/rotational speed measurement mode is set in parameter and pulse density/rotational speed measurement is driven by the HIOEN/DHIOEN instruction. SPD/DSPD instruction ON execution 	<ul style="list-style-type: none"> Pulse density/rotational speed measurement mode is set in parameter and pulse density/rotational speed measurement is stopped by the HIOEN/DHIOEN instruction. SPD/DSPD instruction OFF execution Power ON, reset, STOP, PAUSE

High-speed counter overflow

Flag that detects counter value overflow of high-speed counter.

Corresponding devices

The device numbers corresponding to each channel are as follows.

CPU module							
CH1	CH2	CH3	CH4	CH5	CH6	CH7	CH8
SM4532	SM4533	SM4534	SM4535	SM4536	SM4537	SM4538	SM4539

High-speed pulse input/output module							
First module		Second module		Third module		Fourth module	
CH9	CH10	CH11	CH12	CH13	CH14	CH15	CH16
SM4540	SM4541	SM4542	SM4543	SM4544	SM4545	SM4546	SM4547

Operation Description

The content of the operation when ON and when OFF is as follows.

Operation when ON	Operation when OFF
Overflow occurs (Current value counted = +1 past maximum positive value)	Overflow does not occur

Point

- Does not operate when ring length setting is enabled.
- These devices also operate when the FX3 compatible high-speed counter function is valid.

Update timing

The timing of device update is as follows.

ON	OFF
<ul style="list-style-type: none"> Overflow occurs (This is updated with the END processing. When the FX3 compatible high-speed counter function is valid, the updating is made also when instruction UDCNTF instruction is executed ON.) 	<ul style="list-style-type: none"> When OFF by the user Power ON, reset STOP/PAUSE→RUN SM50 turned ON

High-speed counter underflow

Flag that detects counter value underflow of high-speed counter.

Corresponding devices

The device numbers corresponding to each channel are as follows.

CPU module							
CH1	CH2	CH3	CH4	CH5	CH6	CH7	CH8
SM4548	SM4549	SM4550	SM4551	SM4552	SM4553	SM4554	SM4555

High-speed pulse input/output module							
First module		Second module		Third module		Fourth module	
CH9	CH10	CH11	CH12	CH13	CH14	CH15	CH16
SM4556	SM4557	SM4558	SM4559	SM4560	SM4561	SM4562	SM4563

■Operation Description

The content of the operation when ON and when OFF is as follows.

Operation when ON	Operation when OFF
Underflow occurs (Current value counted = -1 past maximum negative value)	Underflow does not occur

Point

- Does not operate when ring length setting is enabled.
- These devices also operate when the FX3 compatible high-speed counter function is valid.

■Update timing

The timing of device update is as follows.

ON	OFF
<ul style="list-style-type: none"> • Underflow occurs (This is updated with the END processing. When the FX3 compatible high-speed counter function is valid, the updating is made also when UDCNTF instruction is executed ON.) 	<ul style="list-style-type: none"> • When OFF by the user • Power ON, reset • STOP/PAUSE→RUN • SM50 turned ON

High-speed counter count direction monitor

Device for monitoring counter direction.

■Corresponding devices

The device numbers corresponding to each channel are as follows.

CPU module							
CH1	CH2	CH3	CH4	CH5	CH6	CH7	CH8
SM4564	SM4565	SM4566	SM4567	SM4568	SM4569	SM4570	SM4571

High-speed pulse input/output module							
First module		Second module		Third module		Fourth module	
CH9	CH10	CH11	CH12	CH13	CH14	CH15	CH16
SM4572	SM4573	SM4574	SM4575	SM4576	SM4577	SM4578	SM4579

■Operation Description

The content of the operation when ON and when OFF is as follows.

Operation when ON	Operation when OFF
High-speed counter counting in direction whereby current value is reduced (Down-counting)	High-speed counter counting in direction whereby current value is increased (Up-counting)

Point

These devices also operate when the FX3 compatible high-speed counter function is valid.

■Update timing

The timing of device update is as follows.

ON	OFF
Down-counting (This is updated with the END processing. When the FX3 compatible high-speed counter function is valid, the updating is made also when UDCNTF instruction is executed ON.)	<ul style="list-style-type: none"> • Up-counting (When the FX3 compatible high-speed counter function is valid, the updating is made also when UDCNTF instruction is executed ON.) • Power ON, reset • STOP/PAUSE→RUN

High-speed counter (1-phase 1-input S/W) (internal clock) count direction switch

Device for switching counter direction when using 1-phase 1-input (S/W) counter or internal clock.

■Corresponding devices

The device numbers corresponding to each channel are as follows.

CPU module							
CH1	CH2	CH3	CH4	CH5	CH6	CH7	CH8
SM4580	SM4581	SM4582	SM4583	SM4584	SM4585	SM4586	SM4587

High-speed pulse input/output module							
First module		Second module		Third module		Fourth module	
CH9	CH10	CH11	CH12	CH13	CH14	CH15	CH16
SM4588	SM4589	SM4590	SM4591	SM4592	SM4593	SM4594	SM4595

■Operation Description

The content of the operation when ON and when OFF is as follows.

Operation when ON	Operation when OFF
High-speed counter current value counted -1 when input A phase ON	High-speed counter current value counted +1 when input A phase ON

Point

- Setting is ignored for counter other than 1-phase 1-input (S/W), internal clock.
- These devices also operate when the FX3 compatible high-speed counter function is valid.

■Update timing

The timing of device update is as follows.

ON	OFF
When ON by the user (update by END processing)	<ul style="list-style-type: none"> • When OFF by the user (update by END processing) • Power ON, reset • STOP/PAUSE→RUN

Point

Can also be modified while the high-speed counter is operating.

High-speed counter preset input logic

These devices are used for setting the preset input logic.

■Corresponding devices

The device numbers corresponding to each channel are as follows.

CPU module							
CH1	CH2	CH3	CH4	CH5	CH6	CH7	CH8
SM4596	SM4597	SM4598	SM4599	SM4600	SM4601	SM4602	SM4603

High-speed pulse input/output module							
First module		Second module		Third module		Fourth module	
CH9	CH10	CH11	CH12	CH13	CH14	CH15	CH16
SM4604	SM4605	SM4606	SM4607	SM4608	SM4609	SM4610	SM4611

■ Operation Description

The content of the operation when ON and when OFF is as follows.

Operation when ON	Operation when OFF
The preset input operates with negative logic	The preset input operates with positive logic

Point

- The timing to execute the preset is determined by the preset input logic and the preset control switch.
- These devices also operate when the FX3 compatible high-speed counter function is valid.

■ Update timing

The timing of device update is as follows.

ON	OFF
<ul style="list-style-type: none"> • When ON by the user • When set to negative logic with parameters 	<ul style="list-style-type: none"> • When OFF by the user • When set to positive logic with parameters

Point

Cannot be modified while the high-speed counter is operating. Operates in the configured status when the high-speed counter starts.

High-speed counter preset input comparison

These devices are used to specify whether or not to perform a comparison with the preset value when there is preset input.

■ Corresponding devices

The device numbers corresponding to each channel are as follows.

CPU module							
CH1	CH2	CH3	CH4	CH5	CH6	CH7	CH8
SM4612	SM4613	SM4614	SM4615	SM4616	SM4617	SM4618	SM4619

High-speed pulse input/output module							
First module		Second module		Third module		Fourth module	
CH9	CH10	CH11	CH12	CH13	CH14	CH15	CH16
SM4620	SM4621	SM4622	SM4623	SM4624	SM4625	SM4626	SM4627

■ Operation Description

The content of the operation when ON and when OFF is as follows.

Operation when ON	Operation when OFF
Execute comparison processing with the preset value when there is preset input	Do not execute comparison processing when there is preset input

Point

These devices also operate when the FX3 compatible high-speed counter function is valid.

Update timing

The timing of device update is as follows.

ON	OFF
<ul style="list-style-type: none"> When ON by the user When set to enabled with parameters 	<ul style="list-style-type: none"> When OFF by the user When set to disabled with parameters

Point

- Cannot be modified while the high-speed counter is operating. Operates in the configured status when the high-speed counter starts.
- When the current value of a high-speed counter is rewritten with the HCMOV/DHCMOV instruction, the comparison process is not executed.
- When the preset control switch is set to "Constant when ON", the preset input comparison is disabled.

High-speed counter enable input logic

These devices are used for setting the enable input logic.

Corresponding devices

The device numbers corresponding to each channel are as follows.

CPU module							
CH1	CH2	CH3	CH4	CH5	CH6	CH7	CH8
SM4628	SM4629	SM4630	SM4631	SM4632	SM4633	SM4634	SM4635

High-speed pulse input/output module							
First module		Second module		Third module		Fourth module	
CH9	CH10	CH11	CH12	CH13	CH14	CH15	CH16
SM4636	SM4637	SM4638	SM4639	SM4640	SM4641	SM4642	SM4643

Operation Description

The content of the operation when ON and when OFF is as follows.

Operation when ON	Operation when OFF
The enable input operates with negative logic (Enabled when the enable input is OFF)	The enable input operates with positive logic (Enabled when the enable input is ON)

Point

These devices also operate when the FX3 compatible high-speed counter function is valid.

Update timing

The timing of device update is as follows.

ON	OFF
<ul style="list-style-type: none"> When ON by the user When set to negative logic with parameters 	<ul style="list-style-type: none"> When OFF by the user When set to positive logic with parameters

Point

Cannot be modified while the high-speed counter is operating. Operates in the configured status when the high-speed counter starts.

High-speed counter ring length setting

These devices enable or disable the ring length setting for ring counters.

■Corresponding devices

The device numbers corresponding to each channel are as follows.

CPU module							
CH1	CH2	CH3	CH4	CH5	CH6	CH7	CH8
SM4644	SM4645	SM4646	SM4647	SM4648	SM4649	SM4650	SM4651

High-speed pulse input/output module							
First module		Second module		Third module		Fourth module	
CH9	CH10	CH11	CH12	CH13	CH14	CH15	CH16
SM4652	SM4653	SM4654	SM4655	SM4656	SM4657	SM4658	SM4659

■Operation Description

The content of the operation when ON and when OFF is as follows.

Operation when ON	Operation when OFF
Enables the ring length setting for a ring counter (Counts in the range of 0 to ring length counter-1)	Disables the ring length setting for a ring counter (Counts in the range of -2147483648 to +2147483647)



These devices do not operate when the FX3 compatible high-speed counter function is valid.

■Update timing

The timing of device update is as follows.

ON	OFF
<ul style="list-style-type: none"> When ON by the user When set to enabled with parameters 	<ul style="list-style-type: none"> When OFF by the user When set to disabled with parameters



- Cannot be modified while the high-speed counter is operating. Operates in the configured status when the high-speed counter starts.
- The ring length setting is disabled if the pulse density measurement mode or rotational speed measurement mode is selected.

Precautions

If these devices are turned on when a high-speed counter's current value is out of the ring length range, the current value when the high-speed counter is operated is as follows.

- Lower than lower limit value → Lower limit value
- Higher than upper limit value → Upper limit value

High-speed comparison table (high-speed compare instruction) operation

This device is for monitoring the operational status of the high-speed counter's high-speed comparison table and the high-speed comparison instruction.

■Corresponding devices

The device numbers corresponding to each channel are as follows.

CPU module								High-speed pulse input/output module							
								First module		Second module		Third module		Fourth module	
CH1	CH2	CH3	CH4	CH5	CH6	CH7	CH8	CH9	CH10	CH11	CH12	CH13	CH14	CH15	CH16
SM4980								SM4984		SM4988		SM4992		SM4996	

■Operation Description

The content of the operation when ON and when OFF is as follows.

Operation when ON	Operation when OFF
High-speed comparison table operating When the high-speed counter current value and the high-speed comparison table set value or the DHSCS, DHSCR, DHSZ instruction set value are equal, the specified bit device is set or reset.	High-speed comparison table stopped Even when the high-speed counter current value and the high-speed comparison table set value or the DHSCS, DHSCR, DHSZ instruction set value are equal, the specified bit device does not change.

Point

These devices also operate when the FX3 compatible high-speed counter function is valid.

■Update timing

The timing of device update is as follows.

ON	OFF
<ul style="list-style-type: none"> Match output driven by the DHIOEN instruction ON execution by DHSCS, DHSCR, DHSZ instruction 	<ul style="list-style-type: none"> Match output stopped by the DHIOEN instruction and DHSCS, DHSCR, DHSZ instructions all OFF Power ON, reset, STOP, PAUSE

High-speed comparison table (high-speed compare instruction) error occurrence

This device turns ON when driving the DHSCS, DHSCR, and DHSZ instructions in excess of the limitation of the number of instructions driven at the same time or driving the high-speed comparison table in excess of the limitation of the number of the tables starting at the same time.

■Corresponding devices

The device numbers corresponding to each channel are as follows.



CPU module								High-speed pulse input/output module							
								First module		Second module		Third module		Fourth module	
CH1	CH2	CH3	CH4	CH5	CH6	CH7	CH8	CH9	CH10	CH11	CH12	CH13	CH14	CH15	CH16
SM4982								SM4986		SM4990		SM4994		SM4998	

■Operation Description

The content of the operation when ON and when OFF is as follows.

Operation when ON	Operation when OFF
<ul style="list-style-type: none"> DHSCS, DHSCR, DHSZ instructions operated in excess of the limitation of the number of instructions driven at the same time. An operation was made in excess of the limit of number of tables of the high speed comparison table starting at the same time. 	When there is no error DHSCS, DHSCR, DHSZ instructions, and high-speed comparison table can operate

Point

- Even when this device turns ON, if the operation setting of the CPU module operation upon error detection setting ( Page 191 CPU Module Operation Upon Error Detection Setting) is "Continue", the DHSCS, DHSCR, DHSZ instructions within the range of the number of instructions driven at the same time will operate. For the limitation of the number of instructions driven at the same time, refer to  Page 286 Precautions when using high-speed counters.
- These devices also operate when the FX3 compatible high-speed counter function is valid.

■Update timing

The timing of device update is as follows.

ON	OFF
<ul style="list-style-type: none"> Updated in END processing If an error occurs while the FX3 compatible DHSCS, DHSCR, and DHSZ instruction ON execution, an operation is made also when the high-speed counter function is valid. 	<ul style="list-style-type: none"> When OFF by the user Power ON, reset

Multi-point output high-speed comparison table operation

This device is for monitoring the operational status of the high-speed counter's multi-point output high-speed comparison tables.

■Corresponding devices

The device number is shared for all channels of the CPU module.

CH1	CH2	CH3	CH4	CH5	CH6	CH7	CH8
SM5000							

■Operation Description

The content of the operation when ON and when OFF is as follows.

Operation when ON	Operation when OFF
Multi-point output high-speed comparison table operating When the high-speed counter current value is equal to the set value specified in the multi-point output high-speed comparison table parameters, the specified pattern of output or the data transfer operates.	Multi-point output high-speed comparison tables stopped Even when the high-speed counter current value is equal to the set value specified in the multi-point output high-speed comparison table parameters, the specified pattern of output or the data transfer is not executed.



These devices also operate when the FX3 compatible high-speed counter function is valid.

■Update timing

The timing of device update is as follows.

ON	OFF
<ul style="list-style-type: none"> Match output driven by the HIOEN/DHIOEN instruction ON execution by DHSCS, DHSCR, DHSZ instruction 	<ul style="list-style-type: none"> Match output stopped by the HIOEN/DHIOEN instruction and DHSCS, DHSCR, DHSZ instructions all OFF Power ON, reset, STOP, PAUSE SM8034 turned ON

Multi-point output high-speed comparison table completion

This device turns ON when the high-speed counter's multi-point output high-speed comparison tables have finished comparing all of the set tables.

■Corresponding devices

The device number is shared for all channels of the CPU module.

CH1	CH2	CH3	CH4	CH5	CH6	CH7	CH8
SM5001							

■Operation Description

The content of the operation when ON and when OFF is as follows.

Operation when ON	Operation when OFF
Multi-point output high-speed comparison table completion The comparison of the final table has finished	Multi-point output high-speed comparison tables not finished The comparison has not finished up to the final table



These devices also operate when the FX3 compatible high-speed counter function is valid.

■Update timing

The timing of device update is as follows.

ON	OFF
When multi-point output high-speed comparison tables have finished processing the set amount of tables	<ul style="list-style-type: none"> When OFF by the user Power ON, reset, STOP, PAUSE

Special registers list

The following list shows the special registers used with high-speed counters. All set values except for ring length are handled as signed.

Special registers for individual channels

The following list shows the special registers for individual high-speed counter channels.

○: Supported, ×: Not supported

R: Read only, R/W: Read or Write

Special register	Function	Range	Default	Function support		R/W
				FX5UJ	FX5U/ FX5UC	
SD4500	High-speed counter current value (CH1)	-2147483648 to +2147483647	0	○	○	R/W
SD4501						
SD4502	High-speed counter maximum value (CH1)	-2147483648 to +2147483647	-2147483648	○	○	R/W
SD4503						
SD4504	High-speed counter minimum value (CH1)	-2147483648 to +2147483647	2147483647	○	○	R/W
SD4505						
SD4506	High-speed counter pulse density (CH1)	0 to 2147483647	0	○	○	R/W
SD4507						
SD4508	High-speed counter rotational speed (CH1)	0 to 2147483647	0	○	○	R/W
SD4509						
SD4510	High-speed counter preset control switch (CH1)	0: Rising edge 1: Falling edge 2: Both edges 3: Constant when ON	Parameter set value	○	○	R/W
SD4511	Not used	—	—	—	—	—
SD4512	High-speed counter preset value (CH1)	-2147483648 to +2147483647	Parameter set value	○	○	R/W
SD4513						
SD4514	High-speed counter ring length (CH1)	2 to 2147483648	Parameter set value	○	○	R/W
SD4515						
SD4516	High-speed counter measurement unit time (CH1)	1 to 2147483647	Parameter set value	○	○	R/W
SD4517						
SD4518	High-speed counter number of pulses per rotation (CH1)	1 to 2147483647	Parameter set value	○	○	R/W
SD4519						
SD4520 to SD4529	Not used	—	—	—	—	—
SD4530	High-speed counter current value (CH2)	-2147483648 to +2147483647	0	○	○	R/W
SD4531						
SD4532	High-speed counter maximum value (CH2)	-2147483648 to +2147483647	-2147483648	○	○	R/W
SD4533						
SD4534	High-speed counter minimum value (CH2)	-2147483648 to +2147483647	2147483647	○	○	R/W
SD4535						
SD4536	High-speed counter pulse density (CH2)	0 to 2147483647	0	○	○	R/W
SD4537						
SD4538	High-speed counter rotational speed (CH2)	0 to 2147483647	0	○	○	R/W
SD4539						
SD4540	High-speed counter preset control switch (CH2)	0: Rising edge 1: Falling edge 2: Both edges 3: Constant when ON	Parameter set value	○	○	R/W
SD4541	Not used	—	—	—	—	—
SD4542	High-speed counter preset value (CH2)	-2147483648 to +2147483647	Parameter set value	○	○	R/W
SD4543						

Special register	Function	Range	Default	Function support		R/W
				FX5UJ	FX5U/ FX5UC	
SD4544	High-speed counter ring length (CH2)	2 to 2147483648	Parameter set value	○	○	R/W
SD4545						
SD4546	High-speed counter measurement unit time (CH2)	1 to 2147483647	Parameter set value	○	○	R/W
SD4547						
SD4548	High-speed counter number of pulses per rotation (CH2)	1 to 2147483647	Parameter set value	○	○	R/W
SD4549						
SD4550 to SD4559	Not used	—	—	—	—	—
SD4560	High-speed counter current value (CH3)	-2147483648 to +2147483647	0	○	○	R/W
SD4561						
SD4562	High-speed counter maximum value (CH3)	-2147483648 to +2147483647	-2147483648	○	○	R/W
SD4563						
SD4564	High-speed counter minimum value (CH3)	-2147483648 to +2147483647	2147483647	○	○	R/W
SD4565						
SD4566	High-speed counter pulse density (CH3)	0 to 2147483647	0	○	○	R/W
SD4567						
SD4568	High-speed counter rotational speed (CH3)	0 to 2147483647	0	○	○	R/W
SD4569						
SD4570	High-speed counter preset control switch (CH3)	0: Rising edge 1: Falling edge 2: Both edges 3: Constant when ON	Parameter set value	○	○	R/W
SD4571	Not used	—	—	—	—	—
SD4572	High-speed counter preset value (CH3)	-2147483648 to +2147483647	Parameter set value	○	○	R/W
SD4573						
SD4574	High-speed counter ring length (CH3)	2 to 2147483648	Parameter set value	○	○	R/W
SD4575						
SD4576	High-speed counter measurement unit time (CH3)	1 to 2147483647	Parameter set value	○	○	R/W
SD4577						
SD4578	High-speed counter number of pulses per rotation (CH3)	1 to 2147483647	Parameter set value	○	○	R/W
SD4579						
SD4580 to SD4589	Not used	—	—	—	—	—
SD4590	High-speed counter current value (CH4)	-2147483648 to +2147483647	0	○	○	R/W
SD4591						
SD4592	High-speed counter maximum value (CH4)	-2147483648 to +2147483647	-2147483648	○	○	R/W
SD4593						
SD4594	High-speed counter minimum value (CH4)	-2147483648 to +2147483647	2147483647	○	○	R/W
SD4595						
SD4596	High-speed counter pulse density (CH4)	0 to 2147483647	0	○	○	R/W
SD4597						
SD4598	High-speed counter rotational speed (CH4)	0 to 2147483647	0	○	○	R/W
SD4599						
SD4600	High-speed counter preset control switch (CH4)	0: Rising edge 1: Falling edge 2: Both edges 3: Constant when ON	Parameter set value	○	○	R/W
SD4601	Not used	—	—	—	—	—
SD4602	High-speed counter preset value (CH4)	-2147483648 to +2147483647	Parameter set value	○	○	R/W
SD4603						
SD4604	High-speed counter ring length (CH4)	2 to 2147483648	Parameter set value	○	○	R/W
SD4605						

Special register	Function	Range	Default	Function support		R/W
				FX5UJ	FX5U/ FX5UC	
SD4606	High-speed counter measurement unit time (CH4)	1 to 2147483647	Parameter set value	○	○	R/W
SD4607						
SD4608	High-speed counter number of pulses per rotation (CH4)	1 to 2147483647	Parameter set value	○	○	R/W
SD4609						
SD4610 to SD4619	Not used	—	—	—	—	—
SD4620	High-speed counter current value (CH5)	-2147483648 to +2147483647	0	○	○	R/W
SD4621						
SD4622	High-speed counter maximum value (CH5)	-2147483648 to +2147483647	-2147483648	○	○	R/W
SD4623						
SD4624	High-speed counter minimum value (CH5)	-2147483648 to +2147483647	2147483647	○	○	R/W
SD4625						
SD4626	High-speed counter pulse density (CH5)	0 to 2147483647	0	○	○	R/W
SD4627						
SD4628	High-speed counter rotational speed (CH5)	0 to 2147483647	0	○	○	R/W
SD4629						
SD4630	High-speed counter preset control switch (CH5)	0: Rising edge 1: Falling edge 2: Both edges 3: Constant when ON	Parameter set value	○	○	R/W
SD4631	Not used	—	—	—	—	—
SD4632	High-speed counter preset value (CH5)	-2147483648 to +2147483647	Parameter set value	○	○	R/W
SD4633						
SD4634	High-speed counter ring length (CH5)	2 to 2147483648	Parameter set value	○	○	R/W
SD4635						
SD4636	High-speed counter measurement unit time (CH5)	1 to 2147483647	Parameter set value	○	○	R/W
SD4637						
SD4638	High-speed counter number of pulses per rotation (CH5)	1 to 2147483647	Parameter set value	○	○	R/W
SD4639						
SD4640 to SD4649	Not used	—	—	—	—	—
SD4650	High-speed counter current value (CH6)	-2147483648 to +2147483647	0	○	○	R/W
SD4651						
SD4652	High-speed counter maximum value (CH6)	-2147483648 to +2147483647	-2147483648	○	○	R/W
SD4653						
SD4654	High-speed counter minimum value (CH6)	-2147483648 to +2147483647	2147483647	○	○	R/W
SD4655						
SD4656	High-speed counter pulse density (CH6)	0 to 2147483647	0	○	○	R/W
SD4657						
SD4658	High-speed counter rotational speed (CH6)	0 to 2147483647	0	○	○	R/W
SD4659						
SD4660	High-speed counter preset control switch (CH6)	0: Rising edge 1: Falling edge 2: Both edges 3: Constant when ON	Parameter set value	○	○	R/W
SD4661	Not used	—	—	—	—	—
SD4662	High-speed counter preset value (CH6)	-2147483648 to +2147483647	Parameter set value	○	○	R/W
SD4663						
SD4664	High-speed counter ring length (CH6)	2 to 2147483648	Parameter set value	○	○	R/W
SD4665						
SD4666	High-speed counter measurement unit time (CH6)	1 to 2147483647	Parameter set value	○	○	R/W
SD4667						

Special register	Function	Range	Default	Function support		R/W
				FX5UJ	FX5U/ FX5UC	
SD4668	High-speed counter number of pulses per rotation (CH6)	1 to 2147483647	Parameter set value	○	○	R/W
SD4669						
SD4670 to SD4679	Not used	—	—	—	—	—
SD4680	High-speed counter current value (CH7)	-2147483648 to +2147483647	0	○	○	R/W
SD4681						
SD4682	High-speed counter maximum value (CH7)	-2147483648 to +2147483647	-2147483648	○	○	R/W
SD4683						
SD4684	High-speed counter minimum value (CH7)	-2147483648 to +2147483647	2147483647	○	○	R/W
SD4685						
SD4686	High-speed counter pulse density (CH7)	0 to 2147483647	0	○	○	R/W
SD4687						
SD4688	High-speed counter rotational speed (CH7)	0 to 2147483647	0	○	○	R/W
SD4689						
SD4690	High-speed counter preset control switch (CH7)	0: Rising edge 1: Falling edge 2: Both edges 3: Constant when ON	Parameter set value	○	○	R/W
SD4691						
SD4692	High-speed counter preset value (CH7)	-2147483648 to +2147483647	Parameter set value	○	○	R/W
SD4693						
SD4694	High-speed counter ring length (CH7)	2 to 2147483648	Parameter set value	○	○	R/W
SD4695						
SD4696	High-speed counter measurement unit time (CH7)	1 to 2147483647	Parameter set value	○	○	R/W
SD4697						
SD4698	High-speed counter number of pulses per rotation (CH7)	1 to 2147483647	Parameter set value	○	○	R/W
SD4699						
SD4700 to SD4709	Not used	—	—	—	—	—
SD4710	High-speed counter current value (CH8)	-2147483648 to +2147483647	0	○	○	R/W
SD4711						
SD4712	High-speed counter maximum value (CH8)	-2147483648 to +2147483647	-2147483648	○	○	R/W
SD4713						
SD4714	High-speed counter minimum value (CH8)	-2147483648 to +2147483647	2147483647	○	○	R/W
SD4715						
SD4716	High-speed counter pulse density (CH8)	0 to 2147483647	0	○	○	R/W
SD4717						
SD4718	High-speed counter rotational speed (CH8)	0 to 2147483647	0	○	○	R/W
SD4719						
SD4720	High-speed counter preset control switch (CH8)	0: Rising edge 1: Falling edge 2: Both edges 3: Constant when ON	Parameter set value	○	○	R/W
SD4721						
SD4722	High-speed counter preset value (CH8)	-2147483648 to +2147483647	Parameter set value	○	○	R/W
SD4723						
SD4724	High-speed counter ring length (CH8)	2 to 2147483648	Parameter set value	○	○	R/W
SD4725						
SD4726	High-speed counter measurement unit time (CH8)	1 to 2147483647	Parameter set value	○	○	R/W
SD4727						
SD4728	High-speed counter number of pulses per rotation (CH8)	1 to 2147483647	Parameter set value	○	○	R/W
SD4729						

Special register	Function	Range	Default	Function support		R/W
				FX5UJ	FX5U/ FX5UC	
SD4730 to SD4739	Not used	—	—	—	—	—
SD4740 SD4741	High-speed counter current value (CH9)	-2147483648 to +2147483647	0	×	○	R/W
SD4742 SD4743	High-speed counter maximum value (CH9)	-2147483648 to +2147483647	-2147483648	×	○	R/W
SD4744 SD4745	High-speed counter minimum value (CH9)	-2147483648 to +2147483647	2147483647	×	○	R/W
SD4746 to SD4749	Not used	—	—	—	—	—
SD4750	High-speed counter preset control switch (CH9)	0: Rising edge 1: Falling edge 2: Both edges 3: Constant when ON	Parameter set value	×	○	R/W
SD4751	Not used	—	—	—	—	—
SD4752 SD4753	High-speed counter preset value (CH9)	-2147483648 to +2147483647	Parameter set value	×	○	R/W
SD4754 SD4755	High-speed counter ring length (CH9)	2 to 2147483648	Parameter set value	×	○	R/W
SD4756 to SD4769	Not used	—	—	—	—	—
SD4770 SD4771	High-speed counter current value (CH10)	-2147483648 to +2147483647	0	×	○	R/W
SD4772 SD4773	High-speed counter maximum value (CH10)	-2147483648 to +2147483647	-2147483648	×	○	R/W
SD4774 SD4775	High-speed counter minimum value (CH10)	-2147483648 to +2147483647	2147483647	×	○	R/W
SD4776 to SD4779	Not used	—	—	—	—	—
SD4780	High-speed counter preset control switch (CH10)	0: Rising edge 1: Falling edge 2: Both edges 3: Constant when ON	Parameter set value	×	○	R/W
SD4781	Not used	—	—	—	—	—
SD4782 SD4783	High-speed counter preset value (CH10)	-2147483648 to +2147483647	Parameter set value	×	○	R/W
SD4784 SD4785	High-speed counter ring length (CH10)	2 to 2147483648	Parameter set value	×	○	R/W
SD4786 to SD4799	Not used	—	—	—	—	—
SD4800 SD4801	High-speed counter current value (CH11)	-2147483648 to +2147483647	0	×	○	R/W
SD4802 SD4803	High-speed counter maximum value (CH11)	-2147483648 to +2147483647	-2147483648	×	○	R/W
SD4804 SD4805	High-speed counter minimum value (CH11)	-2147483648 to +2147483647	2147483647	×	○	R/W
SD4806 to SD4809	Not used	—	—	—	—	—
SD4810	High-speed counter preset control switch (CH11)	0: Rising edge 1: Falling edge 2: Both edges 3: Constant when ON	Parameter set value	×	○	R/W
SD4811	Not used	—	—	—	—	—
SD4812 SD4813	High-speed counter preset value (CH11)	-2147483648 to +2147483647	Parameter set value	×	○	R/W

Special register	Function	Range	Default	Function support		R/W
				FX5UJ	FX5U/ FX5UC	
SD4814	High-speed counter ring length (CH11)	2 to 2147483648	Parameter set value	×	○	R/W
SD4815						
SD4816 to SD4829	Not used	—	—	—	—	—
SD4830	High-speed counter current value (CH12)	-2147483648 to +2147483647	0	×	○	R/W
SD4831						
SD4832	High-speed counter maximum value (CH12)	-2147483648 to +2147483647	-2147483648	×	○	R/W
SD4833						
SD4834	High-speed counter minimum value (CH12)	-2147483648 to +2147483647	2147483647	×	○	R/W
SD4835						
SD4836 to SD4839	Not used	—	—	—	—	—
SD4840	High-speed counter preset control switch (CH12)	0: Rising edge 1: Falling edge 2: Both edges 3: Constant when ON	Parameter set value	×	○	R/W
SD4841						
SD4842	High-speed counter preset value (CH12)	-2147483648 to +2147483647	Parameter set value	×	○	R/W
SD4843						
SD4844	High-speed counter ring length (CH12)	2 to 2147483648	Parameter set value	×	○	R/W
SD4845						
SD4846 to SD4859	Not used	—	—	—	—	—
SD4860	High-speed counter current value (CH13)	-2147483648 to +2147483647	0	×	○	R/W
SD4861						
SD4862	High-speed counter maximum value (CH13)	-2147483648 to +2147483647	-2147483648	×	○	R/W
SD4863						
SD4864	High-speed counter minimum value (CH13)	-2147483648 to +2147483647	2147483647	×	○	R/W
SD4865						
SD4866 to SD4869	Not used	—	—	—	—	—
SD4870	High-speed counter preset control switch (CH13)	0: Rising edge 1: Falling edge 2: Both edges 3: Constant when ON	Parameter set value	×	○	R/W
SD4871						
SD4872	High-speed counter preset value (CH13)	-2147483648 to +2147483647	Parameter set value	×	○	R/W
SD4873						
SD4874	High-speed counter ring length (CH13)	2 to 2147483648	Parameter set value	×	○	R/W
SD4875						
SD4876 to SD4889	Not used	—	—	—	—	—
SD4890	High-speed counter current value (CH14)	-2147483648 to +2147483647	0	×	○	R/W
SD4891						
SD4892	High-speed counter maximum value (CH14)	-2147483648 to +2147483647	-2147483648	×	○	R/W
SD4893						
SD4894	High-speed counter minimum value (CH14)	-2147483648 to +2147483647	2147483647	×	○	R/W
SD4895						
SD4896 to SD4899	Not used	—	—	—	—	—
SD4900	High-speed counter preset control switch (CH14)	0: Rising edge 1: Falling edge 2: Both edges 3: Constant when ON	Parameter set value	×	○	R/W
SD4901						
SD4901	Not used	—	—	—	—	—

Special register	Function	Range	Default	Function support		R/W
				FX5UJ	FX5U/ FX5UC	
SD4902	High-speed counter preset value (CH14)	-2147483648 to +2147483647	Parameter set value	×	○	R/W
SD4903						
SD4904	High-speed counter ring length (CH14)	2 to 2147483648	Parameter set value	×	○	R/W
SD4905						
SD4906 to SD4919	Not used	—	—	—	—	—
SD4920	High-speed counter current value (CH15)	-2147483648 to +2147483647	0	×	○	R/W
SD4921						
SD4922	High-speed counter maximum value (CH15)	-2147483648 to +2147483647	-2147483648	×	○	R/W
SD4923						
SD4924	High-speed counter minimum value (CH15)	-2147483648 to +2147483647	2147483647	×	○	R/W
SD4925						
SD4926 to SD4929	Not used	—	—	—	—	—
SD4930	High-speed counter preset control switch (CH15)	0: Rising edge 1: Falling edge 2: Both edges 3: Constant when ON	Parameter set value	×	○	R/W
SD4931						
SD4932	High-speed counter preset value (CH15)	-2147483648 to +2147483647	Parameter set value	×	○	R/W
SD4933						
SD4934	High-speed counter ring length (CH15)	2 to 2147483648	Parameter set value	×	○	R/W
SD4935						
SD4936 to SD4949	Not used	—	—	—	—	—
SD4950	High-speed counter current value (CH16)	-2147483648 to +2147483647	0	×	○	R/W
SD4951						
SD4952	High-speed counter maximum value (CH16)	-2147483648 to +2147483647	-2147483648	×	○	R/W
SD4953						
SD4954	High-speed counter minimum value (CH16)	-2147483648 to +2147483647	2147483647	×	○	R/W
SD4955						
SD4956 to SD4959	Not used	—	—	—	—	—
SD4960	High-speed counter preset control switch (CH16)	0: Rising edge 1: Falling edge 2: Both edges 3: Constant when ON	Parameter set value	×	○	R/W
SD4961						
SD4962	High-speed counter preset value (CH16)	-2147483648 to +2147483647	Parameter set value	×	○	R/W
SD4963						
SD4964	High-speed counter ring length (CH16)	2 to 2147483648	Parameter set value	×	○	R/W
SD4965						
SD4966 to SD4979	Not used	—	—	—	—	—

Special registers shared by all channels

A list of shared special registers is provided below.

○: Supported, ×: Not supported

R: Read only, R/W: Read or Write

Special register	Function	Range	Default	Function support		R/W
				FX5UJ	FX5U/ FX5UC	
SD4982	High-speed comparison table (high-speed compare instruction) error occurrence error code (CPU module)	0: When there is no error 3780H: High-speed comparison table maximum excess error	0	○	○	R/W
SD4986	High-speed comparison table error occurrence error code (high-speed pulse input/output module first module)			×	○	
SD4990	High-speed comparison table error occurrence error code (high-speed pulse input/output module second module)			×	○	
SD4994	High-speed comparison table error occurrence error code (high-speed pulse input/output module third module)			×	○	
SD4998	High-speed comparison table error occurrence error code (high-speed pulse input/output module fourth module)			×	○	
SD5000	Multi-point output high-speed comparison table comparison number	0 to 128	0	○	○	R

Special register details

This section describes details about the special registers used with the high-speed counters.

High-speed counter current value

These devices store the current values of the high-speed counters.

■Corresponding devices

The device numbers corresponding to each channel are as follows.

CPU module							
CH1	CH2	CH3	CH4	CH5	CH6	CH7	CH8
SD4501, SD4500	SD4531, SD4530	SD4561, SD4560	SD4591, SD4590	SD4621, SD4620	SD4651, SD4650	SD4681, SD4680	SD4711, SD4710

High-speed pulse input/output module							
First module		Second module		Third module		Fourth module	
CH9	CH10	CH11	CH12	CH13	CH14	CH15	CH16
SD4741, SD4740	SD4771, SD4770	SD4801, SD4800	SD4831, SD4830	SD4861, SD4860	SD4891, SD4890	SD4921, SD4920	SD4951, SD4950

■Description

These devices stores the current values of the high-speed counters.

These are signed 32-bit ring counters. (Upper limit value+1 changes to → lower limit value, lower limit value-1 changes to → upper limit value.)

When the ring length is not set, lower limit value: -2147483648, upper limit value: 2147483647.

When the ring length is set, lower limit value: 0, upper limit value: ring length-1.

Point

- To rewrite the current value, use the HCMOV/DHCMOV instruction and transfer the desired value. However, this is the upper limit when set to a value that exceeds the upper limit value, and this is the lower limit value when set to a value that is less than the lower limit value.
- If the current value falls outside the ring length range when the ring length is set, the upper and lower limit values of the ring length are ignored and the current value is used.
- The current value is retained even when the power is OFF.

■Update timing

The current value of the high-speed counter is updated in END processing or when the HCMOV/DHCMOV instruction is executed. Further, when the FX3 compatible high-speed counter function is valid, the value is updated also when UDCNTF instruction is executed.

■Clear timing

The timing when the device is cleared is as follows.

- Cleared by the HCMOV/DHCMOV instruction
- When the RST LC□ instruction executes ON (only when the FX3 compatible high-speed counter function is valid and the applicable LC device is used)
- Power ON, reset, RUN→STOP (only when the FX3 compatible high-speed counter function is valid and the applicable LC device is used)

High-speed counter maximum value

These devices store the maximum values of the high-speed counters.

■Corresponding devices

The device numbers corresponding to each channel are as follows.

CPU module							
CH1	CH2	CH3	CH4	CH5	CH6	CH7	CH8
SD4503, SD4502	SD4533, SD4532	SD4563, SD4562	SD4593, SD4592	SD4623, SD4622	SD4653, SD4652	SD4683, SD4682	SD4713, SD4712

High-speed pulse input/output module							
First module		Second module		Third module		Fourth module	
CH9	CH10	CH11	CH12	CH13	CH14	CH15	CH16
SD4743, SD4742	SD4773, SD4772	SD4803, SD4802	SD4833, SD4832	SD4863, SD4862	SD4893, SD4892	SD4923, SD4922	SD4953, SD4952

■Description

These devices stores the maximum values of the high-speed counters.

Point

- To rewrite the maximum value, only the HCMOV/DHCMOV instruction can be used.
- If using the enable input, the maximum value is updated when the enable input is ON.
- These devices also operate when the FX3 compatible high-speed counter function is valid.
- If LC45 (CH3: Operation equivalent to C245), LC50 (CH4: Operation equivalent to C250) or LC55 (CH4: Operation equivalent to C255) are used when the FX3 compatible high-speed counter function is valid, special register is updated for the first time when enable input is ON. (After that, regardless of enable input, special register is updated when the high-speed counter starts.)

■Update timing

When the current value of a high-speed counter exceeds the maximum value, the value is updated in END processing. When the value is read using the HCMOV/DHCMOV instruction, it is first updated to the latest value and then read. Further, when the FX3 compatible high-speed counter function is valid, the value is updated also when UDCNTF instruction is executed.

■Clear timing

The timing when the device is cleared is as follows.

- Power ON, Reset

High-speed counter minimum value

These devices store the minimum values of the high-speed counters.

■Corresponding devices

The device numbers corresponding to each channel are as follows.

CPU module							
CH1	CH2	CH3	CH4	CH5	CH6	CH7	CH8
SD4505, SD4504	SD4535, SD4534	SD4565, SD4564	SD4595, SD4594	SD4625, SD4624	SD4655, SD4654	SD4685, SD4684	SD4715, SD4714

High-speed pulse input/output module							
First module		Second module		Third module		Fourth module	
CH9	CH10	CH11	CH12	CH13	CH14	CH15	CH16
SD4745, SD4744	SD4775, SD4774	SD4805, SD4804	SD4835, SD4834	SD4865, SD4864	SD4895, SD4894	SD4925, SD4924	SD4955, SD4954

■Description

These devices stores the minimum values of the high-speed counters.

Point

- To rewrite the minimum value, only the HCMOV/DHCMOV instruction can be used.
- If using the enable input, the minimum value is updated when the enable input is ON.
- These devices also operate when the FX3 compatible high-speed counter function is valid.
- If LC45 (CH3: Operation equivalent to C245), LC50 (CH4: Operation equivalent to C250) or LC55 (CH4: Operation equivalent to C255) are used when the FX3 compatible high-speed counter function is valid, special register is updated for the first time when enable input is ON. (After that, regardless of enable input, special register is updated when the high-speed counter starts.)

■Update timing

When the current value of a high-speed counter becomes less than the minimum value, the value is updated in END processing. When the value is read using the HCMOV/DHCMOV instruction, it is first updated to the latest value and then read. Further, when the FX3 compatible high-speed counter function is valid, the value is updated also when UDCNTF instruction is executed.

■Clear timing

The timing when the device is cleared is as follows.

- Power ON, Reset

High-speed counter pulse density

These devices store the measurement results of pulse density measurement mode.

■Corresponding devices

The device numbers corresponding to each channel of the CPU module are as follows.

CH1	CH2	CH3	CH4	CH5	CH6	CH7	CH8
SD4507, SD4506	SD4537, SD4536	SD4567, SD4566	SD4597, SD4596	SD4627, SD4626	SD4657, SD4656	SD4687, SD4686	SD4717, SD4716

■Description

These devices store the measurement results of pulse density measurement mode (rotational speed measurement mode).

Point

- These devices also store the pulse density measurement when in rotational speed measurement mode.
- If the FX3 compatible high-speed counter function is valid, these devices operate only when the SPD/DSPD instruction operates.

■Update timing

The pulse density is updated at each measurement unit time when set to pulse density measurement mode (rotational speed measurement mode) with parameters.

■Clear timing

The timing when the device is cleared is as follows.

- Power ON, Reset, STOP/PAUSE→RUN

High-speed counter rotational speed

These devices store the measurement results of rotational speed measurement mode.

■Corresponding devices

The device numbers corresponding to each channel of the CPU module are as follows.

CH1	CH2	CH3	CH4	CH5	CH6	CH7	CH8
SD4509, SD4508	SD4539, SD4538	SD4569, SD4568	SD4599, SD4598	SD4629, SD4628	SD4659, SD4658	SD4689, SD4688	SD4719, SD4718

■Description

These devices store the measurement results of rotational speed measurement mode.

Point

- These devices also store the rotational speed when in pulse density measurement mode.
- These devices do not operate when the FX3 compatible high-speed counter function is valid.

■Update timing

The rotational speed is updated at each measurement unit time when set to rotational speed measurement mode with parameters.

■Clear timing

The timing when the device is cleared is as follows.

- Power ON, Reset, STOP/PAUSE→RUN

High-speed counter preset control switch

These devices set the preset input operation of the high-speed counters.

■Corresponding devices

The device numbers corresponding to each channel are as follows.

CPU module							
CH1	CH2	CH3	CH4	CH5	CH6	CH7	CH8
SD4510	SD4540	SD4570	SD4600	SD4630	SD4660	SD4690	SD4720

High-speed pulse input/output module							
First module		Second module		Third module		Fourth module	
CH9	CH10	CH11	CH12	CH13	CH14	CH15	CH16
SD4750	SD4780	SD4810	SD4840	SD4870	SD4900	SD4930	SD4960

■Description

These devices set the timing to execute preset input. The table below shows the operations of the setting values.

Setting value	Description
0	Executes the preset on the rising edge.
1	Executes the preset on the falling edge.
2	Executes the preset on both edges.
3	Constantly executes the preset when ON.*1
Other than above	Operates as the rising edge. Executes the preset on the rising edge.

*1 When the preset control switch is set to "3: Constant when ON", the preset input comparison cannot be used even if the parameter of the preset input comparison (special relay) is enabled.

Point

- While the high-speed counter is operating, the value is not reflected even if modified. It operates in the status when the high-speed counter starts.
- These devices also operate when the FX3 compatible high-speed counter function is valid.

■Clear timing

The timing when the device is cleared is as follows.

- Power ON, Reset, STOP→RUN

■Description of operation

This section describes the operations when the preset input logic and the preset control switch are combined. The preset value is set to 0.

- Operation when preset input logic: positive logic, preset control switch: rising edge

The preset is executed when the preset input changes OFF→ON.

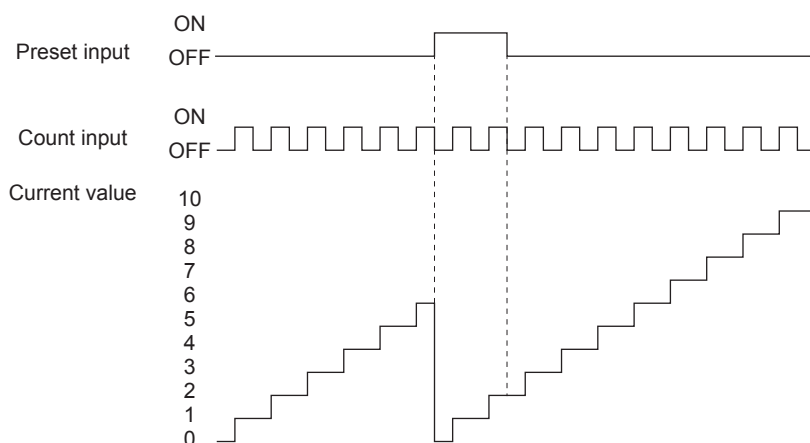

- Operation when preset input logic: positive logic, preset control switch: falling edge

The preset is executed when the preset input changes ON→OFF.

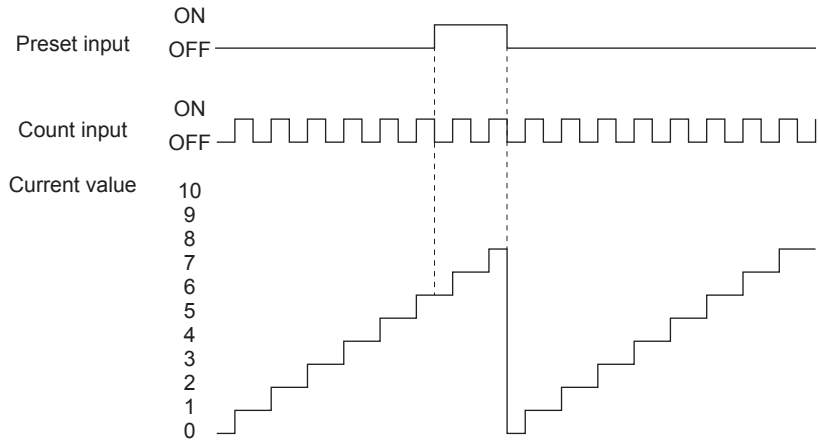

- Operation when preset input logic: positive logic, preset control switch: rising edge + falling edge

The preset is executed when the preset input changes OFF→ON and when it changes ON→OFF.

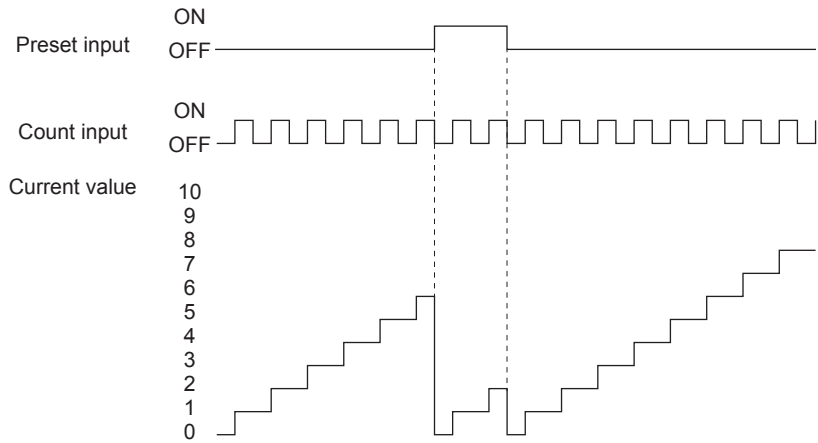

- Operation when preset input logic: positive logic, preset control switch: constant when ON
The preset is constantly executed while the preset input is ON.

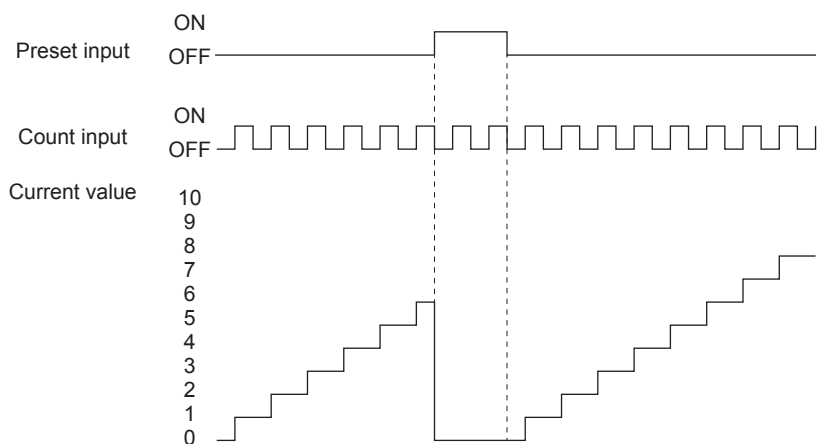

- Operation when preset input logic: negative logic, preset control switch: rising edge
The preset is executed when the preset input changes ON→OFF.

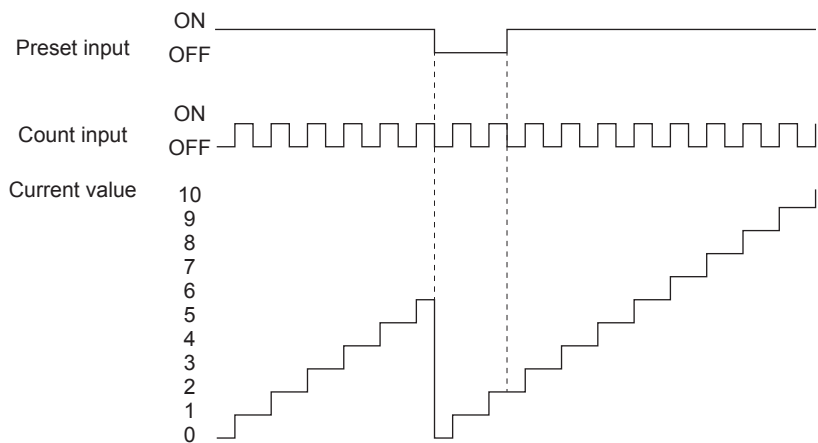

- Operation when preset input logic: negative logic, preset control switch: falling edge
The preset is executed when the preset input changes OFF→ON.

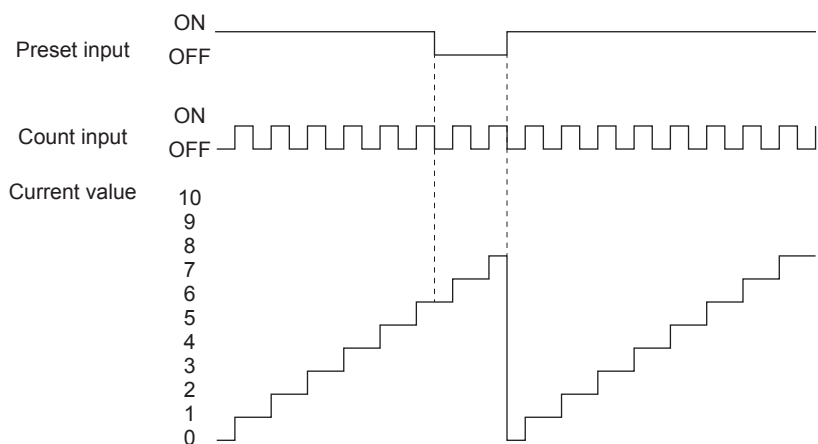

- Operation when preset input logic: negative logic, preset control switch: rising edge + falling edge

The preset is executed when the preset input changes ON→OFF and when it changes OFF→ON.

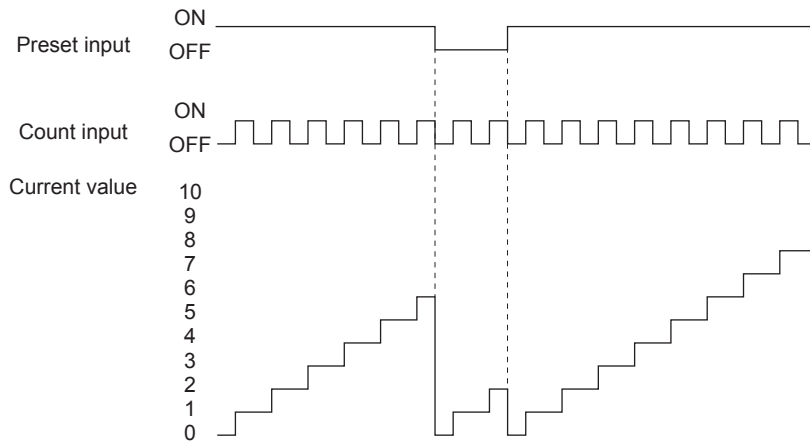

- Operation when preset input logic: negative logic, preset control switch: constant when ON

The preset is constantly executed while the preset input is OFF.

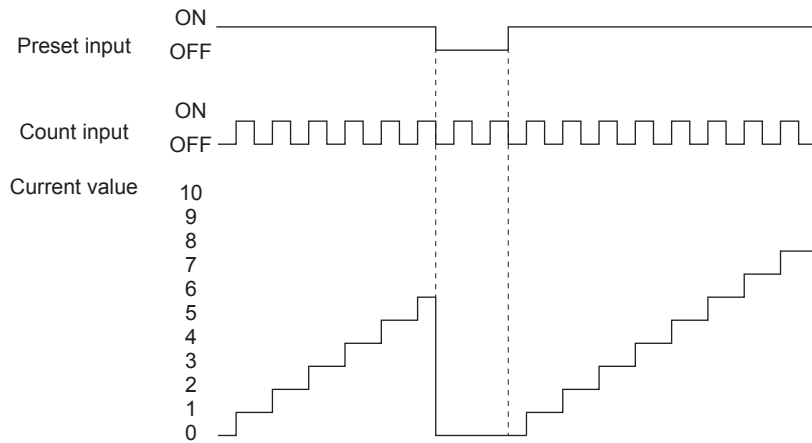

High-speed counter preset value

These devices set the values to store in the current values when presets are executed.

■Corresponding devices

The device numbers corresponding to each channel are as follows.

CPU module							
CH1	CH2	CH3	CH4	CH5	CH6	CH7	CH8
SD4513, SD4512	SD4543, SD4542	SD4573, SD4572	SD4603, SD4602	SD4633, SD4632	SD4663, SD4662	SD4693, SD4692	SD4723, SD4722

High-speed pulse input/output module							
First module		Second module		Third module		Fourth module	
CH9	CH10	CH11	CH12	CH13	CH14	CH15	CH16
SD4753, SD4752	SD4783, SD4782	SD4813, SD4812	SD4843, SD4842	SD4873, SD4872	SD4903, SD4902	SD4933, SD4932	SD4963, SD4962

■Description

These devices set the values to set for the current values when presets are executed.

If the preset value is set to be more than the ring length, an error occurs when the high-speed counter is started.

Point

- The preset value can also be modified while the high-speed counter is operating. The update timing is END processing.
- These devices also operate when the FX3 compatible high-speed counter function is valid.

■Clear timing

The timing when the device is cleared is as follows.

- Power ON, Reset, STOP→RUN

High-speed counter ring length

These devices set the ring length of the high-speed counters.

■Corresponding devices

The device numbers corresponding to each channel are as follows.

CPU module							
CH1	CH2	CH3	CH4	CH5	CH6	CH7	CH8
SD4515, SD4514	SD4545, SD4544	SD4575, SD4574	SD4605, SD4604	SD4635, SD4634	SD4665, SD4664	SD4695, SD4694	SD4725, SD4724

High-speed pulse input/output module							
First module		Second module		Third module		Fourth module	
CH9	CH10	CH11	CH12	CH13	CH14	CH15	CH16
SD4755, SD4754	SD4785, SD4784	SD4815, SD4814	SD4845, SD4844	SD4875, SD4874	SD4905, SD4904	SD4935, SD4934	SD4965, SD4964

■Description

These devices set the ring length of the high-speed counters.

These set values are valid when the ring length setting is set to enabled.

Point

- While the high-speed counter is operating, the value is not reflected even if modified. It operates in the status when the high-speed counter starts.
- These devices do not operate when the FX3 compatible high-speed counter function is valid.

■Clear timing

The timing when the device is cleared is as follows.

- Power ON, Reset, STOP→RUN

Precautions

If the ring length is set to less than the lower limit value or more than the upper limit value, the ring length operates at the lower limit value or the upper limit value. However, the set value is stored as is.

High-speed counter measurement unit time

These devices set the measurement unit of pulse density measurement mode.

■Corresponding devices

The device numbers corresponding to each channel of the CPU module are as follows.

CH1	CH2	CH3	CH4	CH5	CH6	CH7	CH8
SD4517, SD4516	SD4547, SD4546	SD4577, SD4576	SD4607, SD4606	SD4637, SD4636	SD4667, SD4666	SD4697, SD4696	SD4727, SD4726

■Description

These devices set the time to measure pulse density (rotational speed) in 1 ms units when high-speed counters are operating in pulse density measurement mode.

Point

- If the value is modified while the high-speed counter is operating, the rewritten value is reflected after the measurement before the value was modified is finished.
- If the FX3 compatible high-speed counter function is valid, these devices operate only when the SPD/DSPD instruction operates. The value in the operand of the SPD/DSPD instruction is written.

■Clear timing

The timing when the device is cleared is as follows.

- Power ON, Reset, STOP→RUN

Precautions

If the set value for the measurement unit time is set to less than the lower limit value or more than the upper limit value, the measurement unit time operates at the lower limit value or the upper limit value. However, the set value is stored as is.

High-speed counter number of pulses per rotation

These devices set the number of pulses per rotation for rotational speed measurement mode.

■Corresponding devices

The device numbers corresponding to each channel of the CPU module are as follows.

CH1	CH2	CH3	CH4	CH5	CH6	CH7	CH8
SD4519, SD4518	SD4549, SD4548	SD4579, SD4578	SD4609, SD4608	SD4639, SD4638	SD4669, SD4668	SD4699, SD4698	SD4729, SD4728

■Description

These devices set the number of pulses per rotation when a high-speed counter operates in rotational speed measurement mode. The rotational speed is measured with the set value.

Point

- If the value is modified while the high-speed counter is operating, the rewritten value is reflected after the measurement before the value was modified is finished.
- These devices do not operate when the FX3 compatible high-speed counter function is valid.

■Clear timing

The timing when the device is cleared is as follows.

- Power ON, Reset, STOP→RUN

Precautions

If the set value for the number of pulses per rotation is set to less than the lower limit value or more than the upper limit value, the number of pulses per rotation operates at the lower limit value or the upper limit value. However, the set value is stored as is.

High-speed comparison table (high-speed compare instruction) error occurrence error code

This device stores the high-speed comparison table, high-speed comparison instruction error.

■Corresponding devices

The device numbers corresponding to each channel are as follows.

CPU module								High-speed pulse input/output module							
								First module		Second module		Third module		Fourth module	
CH1	CH2	CH3	CH4	CH5	CH6	CH7	CH8	CH9	CH10	CH11	CH12	CH13	CH14	CH15	CH16
SD4982								SD4986		SD4990		SD4994		SD4998	

■Description

This device stores the error code when an error occurs in the high-speed comparison table, high-speed comparison instruction.

Point

These devices also operate when the FX3 compatible high-speed counter function is valid.

■Clear timing

The timing when the device is cleared is as follows.

- Power ON, Reset, SM50 turned ON

■Error code

High-speed comparison table maximum excess error: 3780H

Multi-point output high-speed comparison table comparison number

This device stores the number of the table currently being compared in the multi-point output high-speed comparison tables.

■Corresponding devices

The device number is shared for all channels of the CPU module.

CH1	CH2	CH3	CH4	CH5	CH6	CH7	CH8
SD5000							

■Description

This device stores the number of the table currently being compared in the multi-point output high-speed comparison tables. If 0, the multi-point output high-speed comparison tables have stopped.

Point

- When rewriting the comparison value or output data for the multi-point output high-speed comparison tables, the table numbers from the table numbers that follow after the next table number of the table being compared can be rewritten.
- The table number being compared and the next table number after that can be rewritten, but they will not be compared.
- These devices also operate when the FX3 compatible high-speed counter function is valid.

■Clear timing

The timing when the device is cleared is as follows.

- Power ON, Reset, STOP→RUN

Special relays/special registers capable of high-speed transfers with the HCMOV/DHCMOV instruction

The table below shows the devices that can read and write the latest value with the HCMOV/DHCMOV instruction from special relays and special registers related to the high-speed counters. When special relays and special registers are specified for (s) and (d) of instructions other than the HCMOV/DHCMOV instruction, the operation is the same as one compatible with the MOV/DMOV instruction.

Precautions

- Transfer is not possible between an SM supporting high-speed transfer and an SD supporting high-speed transfer.
- When the device supporting high-speed transfer is set as the transfer source (s) by the DHCMOV instruction while the high-speed input/output function is stopped, the previous value before stop is read out. However, if the function is not executed even once, the initial value is read out.

Special relays for individual channels

○: High-speed transfer capable (special relay is immediately updated)

△: Normal transfer capable (special relay is updated in END processing)

×: Transfer not possible (read-only)

Special relay	Function	Compatible with HCMOV/DHCMOV instruction		Compatible with MOV/DMOV instruction	
		(s)	(d)	(s)	(d)
SM4500 to SM4515	High-speed counter operating	△	×	△	×
SM4516 to SM4531	High-speed counter pulse density/rotational speed being measured	△	×	△	×
SM4532 to SM4547	High-speed counter overflow ^{*1}	○	○	△	△
SM4548 to SM4563	High-speed counter underflow ^{*1}	○	○	△	△
SM4564 to SM4579	High-speed counter count direction monitor ^{*1}	○	×	△	×
SM4580 to SM4595	High-speed counter (1-phase 1-input S/W) count direction switch ^{*1}	△	○	△	△
SM4596 to SM4611	High-speed counter preset input logic	△	△	△	△
SM4612 to SM4627	High-speed counter preset input comparison	△	△	△	△
SM4628 to SM4643	High-speed counter enable input logic	△	△	△	△
SM4644 to SM4659	High-speed counter ring length setting	△	△	△	△

*1 In a program with interruption priority 1, the HCMOV/DHCMOV instruction specified with a device for the high-speed pulse input/output module cannot be executed.

Special relays shared by all channels

○: High-speed transfer capable (special relay is immediately updated)

△: Normal transfer capable (special relay is updated in END processing)

×: Transfer not possible (read-only)

Special relay	Function	Compatible with HCMOV/ DHCMOV instruction		Compatible with MOV/ DMOV instruction	
		(s)	(d)	(s)	(d)
SM4980	High-speed comparison table (high-speed compare instruction) operation (CPU module)	△	×	△	×
SM4982	High-speed comparison table (high-speed compare instruction) error occurrence (CPU module)	△	△	△	△
SM4984	High-speed comparison table operation (high-speed pulse input/output module first module)	△	×	△	×
SM4986	High-speed comparison table error occurrence (high-speed pulse input/output module first module)	△	△	△	△
SM4988	High-speed comparison table operation (high-speed pulse input/output module second module)	△	×	△	×
SM4990	High-speed comparison table error occurrence (high-speed pulse input/output module second module)	△	△	△	△
SM4992	High-speed comparison table operation (high-speed pulse input/output module third module)	△	×	△	×
SM4994	High-speed comparison table error occurrence (high-speed pulse input/output module third module)	△	△	△	△
SM4996	High-speed comparison table operation (high-speed pulse input/output module fourth module)	△	×	△	×
SM4998	High-speed comparison table error occurrence (high-speed pulse input/output module fourth module)	△	△	△	△
SM5000	Multi-point output high-speed comparison table operation	△	×	△	×
SM5001	Multi-point output high-speed comparison table completion	○	△	△	△

Special registers for individual channels

This section only lists the devices for high-speed counter CH1. The devices for high-speed counter CH2 and subsequent counters have the same operation as CH1.

○: High-speed transfer capable (special register is immediately updated)

△: Normal transfer capable (special register is updated in END processing)

×: Transfer not possible (read-only)

Special register	Function	Compatible with HCMOV/DHCMOV instruction		Compatible with MOV/DMOV instruction	
		(s)	(d)	(s)	(d)
SD4500	High-speed counter current value (CH1) ^{*1}	○	○	△	×
SD4501					
SD4502	High-speed counter maximum value (CH1) ^{*1}	○	○	△	×
SD4503					
SD4504	High-speed counter minimum value (CH1) ^{*1}	○	○	△	×
SD4505					
SD4506	High-speed counter pulse density (CH1)	△	△	△	△
SD4507					
SD4508	High-speed counter rotational speed (CH1)	△	△	△	△
SD4509					
SD4510	High-speed counter preset control switch (CH1)	△	△	△	△
SD4512	High-speed counter preset value (CH1) ^{*1}	△	○	△	△
SD4513					
SD4514	High-speed counter ring length (CH1)	△	△	△	△
SD4515					
SD4516	High-speed counter measurement unit time (CH1)	△	△	△	△
SD4517					
SD4518	High-speed counter number of pulses per rotation (CH1)	△	△	△	△
SD4519					

*1 In a program with interruption priority 1, the HCMOV/DHCMOV instruction specified with a device for the high-speed pulse input/output module cannot be executed.

Point

Always use DHCMOV (32-bit instruction) for devices that use 2 words. When the HCMOV instruction (16-bit instruction) is used, it operates the same as the normal MOV instruction.

Special registers shared by all channels

○: High-speed transfer capable (special register is immediately updated)

△: Normal transfer capable (special register is updated in END processing)

×: Transfer not possible (read-only)

Special register	Function	Compatible with HCMOV/DHCMOV instruction		Compatible with MOV/DMOV instruction	
		(s)	(d)	(s)	(d)
SD4982	High-speed comparison table (high-speed compare instruction) error occurrence error code (CPU module)	△	△	△	△
SD4986	High-speed comparison table error occurrence error code (high-speed pulse input/output module first module)	△	△	△	△
SD4990	High-speed comparison table error occurrence error code (high-speed pulse input/output module second module)	△	△	△	△
SD4994	High-speed comparison table error occurrence error code (high-speed pulse input/output module third module)	△	△	△	△
SD4998	High-speed comparison table error occurrence error code (high-speed pulse input/output module fourth module)	△	△	△	△
SD5000	Multi-point output high-speed comparison table comparison number	△	×	△	△

Precautions when using high-speed counters

This section describes the precautions when using high-speed counters.

Common precautions when using high-speed counter instructions and parameters

This section describes the common precautions when using high-speed comparison tables and multi-point output comparison tables with the high-speed counter instructions (DHSCS, DHSCR, DHSZ instructions) or parameters. For the individual precautions on high-speed counter instructions, refer to  MELSEC iQ-F FX5 Programming Manual (Instructions, Standard Functions/Function Blocks).

High-speed counter devices

The current values for high-speed counters are checked with special registers for each channel.

To start or stop counting of the high-speed counters, use the HIOEN/DHIOEN instruction or the SPD/DSPD instruction.

- High-speed counter start/stop conditions

Function	Start	Stop
Counting	<ul style="list-style-type: none">• HIOEN/DHIOEN instruction• SPD/DSPD instruction	<ul style="list-style-type: none">• HIOEN/DHIOEN instruction• SPD/DSPD instruction*1
Comparison processing	<ul style="list-style-type: none">• HIOEN/DHIOEN instruction• DHSCS, DHSCR, DHSZ instructions	<ul style="list-style-type: none">• HIOEN/DHIOEN instruction• DHSCS, DHSCR, DHSZ instructions*2

*1 Can be stopped when counting was started with the SPD/DSPD instruction.

*2 Can be stopped when the high-speed comparison table is not set with parameters.

Precautions for the counting operation when the current value is changed

For the high-speed counter instructions, high-speed comparison tables, and multi-point output high-speed comparison tables, comparison processing is performed when the current value of the high-speed counter has changed due to pulse input. When the preset input comparison function is also enabled, comparison processing is also performed when the preset is executed. However, please note that the comparison processing is not performed when the current value of the high-speed counter is changed with the following methods.

- When the current value of a high-speed counter was rewritten with the HCMOV/DHCMOV instruction.
- When the current value of the high-speed counter is reset with the RST instruction or the ZRST instruction (when the FX3 compatible high-speed counter function is valid)
- When the current value of the high-speed counter was changed by a self-reset. (When the preset input comparison function is disabled)
- When high-speed counter current value is the ON or OFF output result of the comparison of the DHSCS, DHSCR, DHSZ instructions.
- When high-speed counter current value is the ON or OFF output result of the comparison of a high-speed comparison table.

Preset input comparison operation

When the preset input comparison is enabled and preset control switching is set to constant when ON, the preset input comparison does not operate.

Timing at which the instruction is enabled

The DHSCS, DHSCR, DHSZ instructions are enabled at the END instruction for the scan in which the instructions are driven. Even when the comparison value is changed, it is updated at the END instruction for the scan in which it was changed .

Configuring high-speed comparison tables with parameters

Operations of DHSCS, DHSCR, DHSZ instructions of the same comparison value are executed after high-speed comparison tables set with parameters. The high-speed comparison table is processed sequentially from the top of the table.

■High-speed counter current value modification operation by instructions

The table below shows the operations when the current value of a high-speed counter is rewritten by instructions.

Instruction	High-speed counter current value
HCMOV/DHCMOV instruction	☞ Page 283 Special relays/special registers capable of high-speed transfers with the HCMOV/DHCMOV instruction
MOV instruction, etc.	
RST instruction	Cannot reset. The special register value is overwritten in END processing.
ZRST instruction	Cannot reset. The special register value is overwritten in END processing.

■Limitation in the number of instances of each instruction in a program and number of instructions driven at the same time

When DHSCS, DHSCR, DHSZ instructions are driven at the same time in excess of the upper limit, the instructions after the upper limit do not operate.

Instruction	Limitation in number of instructions driven at same time
DHSCS	Up to 32 instructions can be driven at the same time.
DHSCR	There is no limitation in the number used in programs.
DHSZ	

- Configuring high-speed comparison tables with parameters

The number of instructions driven at the same time decreases by 1 for each high-speed comparison table driven by the HIOEN/DHIOEN instruction.

The HIOEN/DHIOEN instruction that drives the high-speed comparison table is capable of driving at the same time 32 instructions in the case of a CPU module and 15 instructions in the case of a high-speed pulse input/output module.

Restriction

Set up the program and configure the settings within the range calculated with the following equation due to the limitations described above.

■CPU module

$32 \geq \text{Number of driven high-speed comparison tables} + \text{Number of DHSCS, DHSCR, DHSZ instructions driven at the same time}$

However, restriction of number of high-speed comparisons differs depending on the version. (☞ Page 566 Added and Enhanced Functions)

■High-speed pulse input/output module

$15 \geq \text{Number of driven high-speed comparison tables}$

■User interrupt

During a program with interruption priority 1, the HIOEN/DHIOEN instruction cannot be executed to start or stop the high-speed counter of a high-speed pulse input/output module. (☞ Page 75 Interrupt priority)

■Operation when the all output disable flag (SM8034) is ON

When the all output disable flag (SM8034) is turned ON, the outputs that were turned ON by high-speed comparison tables, high-speed comparison instructions, or multi-point output high-speed tables are turned OFF. (The image remains ON.)

If SM8034 is turned OFF, the outputs that were turned OFF return to the original state.

For high-speed comparison tables and high-speed comparison instructions, high-speed counters do not stop and comparison processing is performed even when SM8034 is ON, and the image turns ON if there is a match. The actual output is output when SM8034 is OFF.

For multi-point output high-speed comparison tables, the high-speed counter for which the multi-point output high-speed comparison table is operating is stopped when SM8034 is turned ON, and multi-point output comparison processing is also stopped. High-speed counters and multi-point output high-speed comparison tables cannot be operated by turning OFF SM8034 and need to be restarted by the HIOEN/DHIOEN instruction.

The normal high-speed counter function continues to perform counting without being influenced by SM8034.

■ Operation of high-speed comparison table and multiple point output high-speed comparison tables

Do not use the channel of the same high-speed counter on a high-speed comparison table and a multi-point output high-speed comparison table. An error may occur.

Functions that share inputs and outputs

When using input/output for high-speed input/output function, other high-speed input/output functions cannot be used together depending on the combination. For positioning function, refer to  MELSEC iQ-F FX5 User's Manual (Positioning Control - CPU module built-in, High-speed pulse input/output module).

■ FX5UJ CPU module

- Input

The following functions occupy inputs of the high-speed input/output function.

Function		Up to CH/axis	Device	Simultaneous useable function
Input interrupt*1	Interrupt (Rising)	8 CH	X0 to X17	The functions other than high-speed counter (input A phase, input B phase)
	Interrupt (Falling)			
	Interrupt (Rising + Falling)			
	Interrupt (Rising) + Pulse Catch			Cannot be combined
High-speed counter	Input A phase	8 CH*2	X0 to X17	—
	Input B phase			
	Input external preset			Input interrupt
	Input external enable			
Pulse width measurement		4 CH	X0, X1, X3, X4	Input interrupt
Positioning	Near-point dog signal	3 axis	X0 to X17	• Input interrupt • Zero signal
	Zero signal	3 axis	X0 to X17	• Input interrupt • Near-point dog signal
	Interrupt input signal 1 (Normal mode)	3 axis	X0 to X17	Input interrupt
	External start signal	3 axis	X0 to X17	Input interrupt

*1 If used simultaneously with another function, the input logic of the other function is applied.

*2 When external preset input and external enable input are used, the number of usable channels is decreased depending on the counter type.

- Output

The following functions occupy outputs of the high-speed input/output function. The following functions cannot be combined with other high-speed input/output functions.

Function		Up to CH/axis	Device
PWM*1		4 CH	Y0 to Y7
Positioning	PULSE	3 axis	Y0 to Y2
	SIGN		Y0 to Y17
	Clear signal	3 axis	Y0 to Y17

*1 When positioning is not used, the output devices (Y) for which the positioning setting is enabled with parameters can be used as PWM outputs or general-purpose devices having no parameter.

Precautions

Do not specify an output device (Y) used by the high-speed input/output function as the output destination of the high-speed comparison table. This may cause an unexpected operation.

■FX5U/FX5UC CPU module

• Input

The following functions occupy inputs of the high-speed input/output function.

Function		Up to CH/axis	Device	Simultaneous useable function
Input interrupt*1	Interrupt (Rising)	8 CH	X0 to X17	The functions other than high-speed counter (input A phase, input B phase)
	Interrupt (Falling)			
	Interrupt (Rising + Falling)			
	Interrupt (Rising) + Pulse Catch			Cannot be combined
High-speed counter	Input A phase	8 CH*2	X0 to X17	—
	Input B phase			
	Input external preset			Input interrupt
	Input external enable			
Pulse width measurement	4 CH	X0 to X7	Input interrupt	
Positioning	Near-point dog signal	4 axis	X0 to X17	• Input interrupt • Zero signal
	Zero signal	4 axis	X0 to X17	• Input interrupt • Near-point dog signal
	Interrupt input signal 1 (Normal mode)	4 axis	X0 to X17	Input interrupt
	External start signal	4 axis	X0 to X17	Input interrupt

*1 If used simultaneously with another function, the input logic of the other function is applied.

*2 When external preset input and external enable input are used, the number of usable channels is decreased depending on the counter type.

• Output

The following functions occupy outputs of the high-speed input/output function. The following functions cannot be combined with other high-speed input/output functions.

Function		Up to CH/axis	Device
PWM*1		4 CH	Y0 to Y7
Positioning	PULSE	4 axis	Y0 to Y3
	SIGN		Y0 to Y17
	CW	2 axis	Y0, Y1
	CCW		Y2, Y3
	Clear signal	4 axis	Y0 to Y17

*1 When positioning is not used, the output devices (Y) for which the positioning setting is enabled with parameters can be used as PWM outputs or general-purpose devices having no parameter.

Precautions

Do not specify an output device (Y) used by the high-speed input/output function as the output destination of the high-speed comparison table. This may cause an unexpected operation.

■High-speed pulse input/output module

• Input

The following functions occupy inputs of the high-speed input/output function. The channels and the axis numbers are in module internal order.

Device ^{*1}	Input interrupt ^{*1*2}	High-speed counter	Pulse width measurement	Positioning
X□	X□	CH1 Input A phase	—	—
X□+1	X□+1	CH1 Input B phase/external preset	—	—
X□+2	X□+2	CH1 Input external preset	—	Axis2 Zero signal
X□+3	X□+3	CH2 Input A phase	CH1	Axis2 Interrupt input signal 1
X□+4	X□+4	CH2 Input B phase/external preset	CH2	Axis1 Interrupt input signal 1
X□+5	X□+5	CH2 Input external preset	—	Axis1 Zero signal
X□+6	X□+6	CH1 Input external enable	—	Axis2 External start signal
X□+7	X□+7	CH2 Input external enable	—	Axis1 External start signal

*1 □: Head input number for each high-speed pulse input/output module

*2 Simultaneous use with a function other than the high-speed counter (A phase/B phase input) is possible. However, use with the channel 2 external enable input of the high-speed counter is not possible.

However, the input logic of other functions is applied.

• Output

The following functions occupy outputs of the high-speed input/output function. The channels and the axis numbers are in module internal order. The following functions cannot be combined with other high-speed input/output functions.

Device ^{*1}	PWM	Positioning
Y□	—	Axis1 PULSE/CW
Y□+1	CH1	Axis2 PULSE/CW
Y□+2	—	Axis1 Clear signal
Y□+3	—	Axis2 Clear signal
Y□+4	—	Axis1 SIGN/CCW
Y□+5	CH2	Axis2 SIGN/CCW
Y□+6	—	—
Y□+7	—	—

*1 □: Head output number for each high-speed pulse input/output module

Precautions

Do not specify an output device (Y) used by the high-speed input/output function as the output destination of the high-speed comparison table. This may cause an unexpected operation.

Restrictions on simultaneous execution of the high-speed comparison table and high-speed comparison instructions

There is a limit in the number of simultaneous executions of the high-speed comparison table and high-speed comparison instructions (DHSCS, DHSCR, DHSZ instruction). Shown below are conditions included in the number of simultaneous executions.

Item	CPU module	High-speed pulse input/output module
Maximum executions	32	15
High-speed counter function	<ul style="list-style-type: none"> • Drive high-speed comparison table (Drive HIOEN/DHIOEN instruction) • Drive DHSCS, DHSCR, DHSZ instruction) 	<ul style="list-style-type: none"> • Drive high-speed comparison table (Drive HIOEN/DHIOEN instruction)
Positioning function	<ul style="list-style-type: none"> • Interrupt input signal 1 (High-speed mode) setting is enabled 	<ul style="list-style-type: none"> • OPR setting is enabled • Interrupt input signal 1 (High-speed mode) setting is enabled

Point

- For the high-speed comparison table, only the tables driven by the HIOEN/DHIOEN instruction are included in the number of the simultaneous executions.
- When the positioning function setting is made, high-speed comparison table becomes occupied and is included in the number of simultaneous executions.

26.2 FX3-compatible high-speed counter function

FX3-compatible high-speed counter function is explained below.

FX3-compatible high-speed counter function overview

The FX3 compatible high-speed counter can assign the input terminals compatible with FX3 and use the device equivalent to C235 to C255 of FX3 as LC35 to LC55 (high-speed counter). The FX3-compatible high-speed counter function is not supported in high-speed pulse input/output modules.

If the FX3 compatible high-speed counter is used, it is necessary to use the parameter to set the FX3 compatible high-speed counter to be valid.

This section describes the device (LC35 to LC55) of the FX3 compatible high-speed counter as an LC device.

Point

The FX3 compatible high-speed counter is convenient if it is used when a replacement is made from FX3 or for a similar occasion. If a high-speed counter is newly used, use the high-speed counter function of FX5.

( Page 220 High-speed Counter Function)

How to start/stop the high-speed counter using the LC device

When using a FX3-compatible high-speed counter by the UDCNTF instruction, perform starting/stopping the counting of the high-speed counter. For details of the UDCNTF instruction, refer to  MELSEC iQ-F FX5 Programming Manual (Instructions, Standard Functions/Function Blocks).

Count direction switching

FX3-compatible high-speed count direction switching is performed by ON/OFF of the following methods.

- SM4580 to SM4595 (high-speed counter CH1 to CH16 (1-phase 1-input S/W) count direction switching)

Programs example

In the case of a program shown below, the counting starts when M0 turns ON, and the counting stops when M0 turns OFF. When the counter increases from -6 or less to -5 or higher during an execution of the UDCNTF instruction, the counter contact turns ON, and the counter contact turns OFF when the counter decreases from -5 or higher to -6 or lower. ON/OFF of M1 switches the counting direction. To count from 0, turn ON M2 to reset LC35.

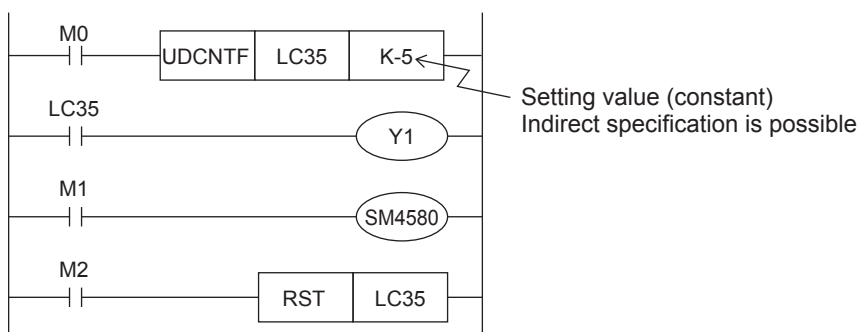

Point

- The current value of LC35 is updated when the UDCNTF instruction is executed.
- When LC35 is set to (s) of the DHCMOV instruction, the newest value can be read out.
- When a high-speed comparison instruction (DHSCS instruction, DHSCR instruction, DHSZ instruction), a high-speed comparison table, or a multi-point output high-speed comparison table are used, an accurate comparison and matched output processing can be executed.

The set value (positive or negative) can be specified by a constant (K) or the contents of data registers (D). When data registers are used, 32-bit data composed of two consecutive devices are treated as set values. If D0 is specified, the pair of D1 and D0 are the setting value of 32 bits.

Operation example

The operation of LC35 in the programming example described above is as shown below.

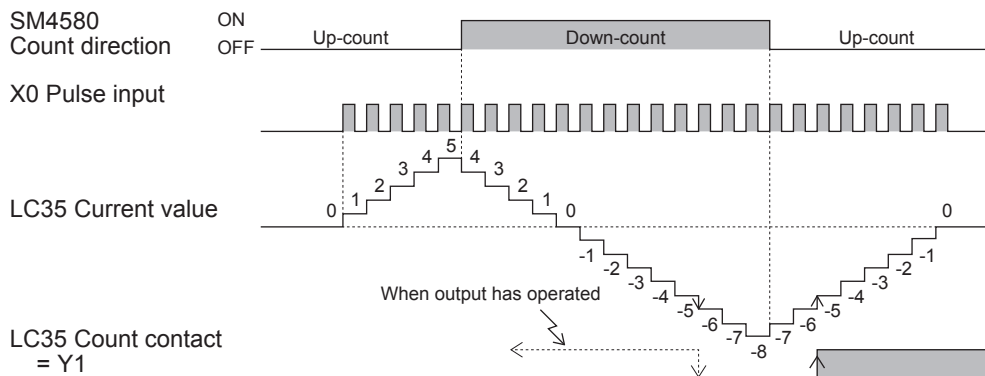

The elements of the composition of the LC device

Each element that composes the LC device is shown below.

Item	Description
Counting coil	This is the activation contact to start the counting of the LC device. When the UDCNTF instruction is turned OFF/ON, the status turns ON and the counting of the input signal becomes possible.
Setting value	This is $K\Box$ specified with UDCNTF LC \Box K \Box . An indirect specification is acceptable.
Current value	This is the current value of the counter. The value increases or decreases depending on the input pulse.
Counter contact	This turns ON when the current value of the LC device changes from a value less than the setting value to the setting value or higher. This can be used as LD LC \Box .
Reset coil	This turns ON when the RST instruction with the LC device specified turns OFF→ON, and turns OFF when the RST instruction turns ON→OFF. When the reset coil is ON, the counting is not executed even if the count coil is ON, and the current value is always 0.

The comparison between the UDCNTF instruction and HIOEN/DHIOEN instruction

The comparison between the UDCNTF instruction and the HIOEN/DHIOEN instruction is described below.

The availability of use when the FX3 compatibility function is enable/disable

FX3-compatible function enable/disable	UDCNTF instruction	HIOEN/DHIOEN instruction
Disable	—	○
Enable	○	○

○: Use

—: Not use

Point

The LC device can be used as a high-speed counter only when the FX3 compatible function is valid. However, this is only the LC device that is set up with parameter. Also, it is possible to use the HIOEN/DHIOEN instruction.

Starting/stopping the counting of the high-speed counter

The start and stop of the counting of the high-speed counter of the UDCNTF instructions and HIOEN/DHIOEN instructions with the FX3 compatible function valid are described below.

For the UDCNTF instruction or HIOEN/DHIOEN instruction, refer to  MELSEC iQ-F FX5 Programming Manual (Instructions, Standard Functions/Function Blocks).

Starting/stopping the counting of the high-speed counter	UDCNTF instruction	HIOEN/DHIOEN instruction
The start of the high-speed counter	○	○
The simultaneous start of multiple CH	×	○
The simultaneous stop of multiple CH	×	○
The start→stop and the stop→start of the same CH in one scan	○	○
The stop of the counter started by the UDCNTF instructions in the same step	○	—
The stop of the counter started by the UDCNTF instructions in a different step	○	×
The stop of the counter started by the HIOEN/DHIOEN instruction the same step	—	○
The stop of the counter started by the HIOEN/DHIOEN instruction a different step	○	○

○: Supported

×: Not supported

—: Not applicable

Point

- If the UDCNTF instructions and HIOEN/DHIOEN instructions are used for the same CH, it is not possible to use the HIOEN/DHIOEN instruction to stop the high-speed counter started by UDCNTF instructions. On the other hand, the instruction started by the HIOEN/DHIOEN instruction can be stopped by executing ON→OFF of UDCNTF instructions. Use caution when the HIOEN/DHIOEN instruction and UDCNTF instructions are used together.
- Do not drive the same LC device number at the same time.
- Do not duplicate output (double coil) the same LC device number with multiple instructions.

The operation of each element of the current value of a started counter and the LC device

Shown below is the operations of the SD device, the current value of the LC device, and each element of the LC device when the counting is started with UDCNTF instructions or is started with the HIOEN/DHIOEN instruction while the FX3 compatible function is valid.

The current value of the SD device, each element of the LC device	The start with UDCNTF instruction	The start with HIOEN/DHIOEN instruction
The current value of the SD device	○	○
The current value of the LC device	○	○
The LC device counting coil	○	×
The counter contact point of the LC device	○	×
The reset coil of the LC device	○	○

○: Operate

×: Not operate

Point

- When a count is started by HIOEN/DHIOEN instruction, although LC device changes, neither a counting coil nor the counter contact operates. Moreover, when operation is started by HIOEN/DHIOEN instruction and LC□ corresponding to CH is reset, during the RST instruction ON, operation is stopped and calculation is resumed in OFF of the RST instruction.

Assignment for FX3-compatible high-speed counters

The high-speed counter number that can be specified with each CH

Shown here are the high-speed counter numbers (C235 to C255) of FX3 that can be selected with each CH.

CH	High-speed counter No.	Pulse input mode	Corresponding devices	Preset input logic change
CH1	C235	1-phase 1-count (S/W)	LC35	—
CH1	C241	1-phase 1-count (S/W)	LC41	○
CH1	C244	1-phase 1-count (S/W)	LC44	○
CH1	C246	1-phase 2-count	LC46	—
CH1	C247	1-phase 2-count	LC47	○
CH1	C249	1-phase 2-count	LC49	○
CH1	C251	2-phase 2-count (1 edge count/4 edge count)	LC51	—
CH1	C252	2-phase 2-count (1 edge count/4 edge count)	LC52	○
CH1	C254	2-phase 2-count (1 edge count/4 edge count)	LC54	○
CH2	C236	1-phase 1-count (S/W)	LC36	—
CH3	C237	1-phase 1-count (S/W)	LC37	—
CH3	C242	1-phase 1-count (S/W)	LC42	○
CH3	C245	1-phase 1-count (S/W)	LC45	○
CH4	C238	1-phase 1-count (S/W)	LC38	—
CH4	C248	1-phase 2-count	LC48	○
CH4	C248 (OP)	1-phase 2-count	LC48	—
CH4	C250	1-phase 2-count	LC50	○
CH4	C253	2-phase 2-count (1 edge count/4 edge count)	LC53	○
CH4	C253 (OP)	2-phase 2-count (1 edge count/4 edge count)	LC53	—
CH4	C255	2-phase 2-count (1 edge count/4 edge count)	LC55	○
CH5	C239	1-phase 1-count (S/W)	LC39	—
CH5	C243	1-phase 1-count (S/W)	LC43	○
CH6	C240	1-phase 1-count (S/W)	LC40	—
CH7	C244 (OP)	1-phase 1-count (S/W)	LC44	—
CH7	C254 (OP)	2-phase 2-count (1 edge count)	LC54	—
CH8	C245 (OP)	1-phase 1-count (H/W)	LC45	—

○: Change is possible

—: Change is impossible

The assignment of the high-speed counter and the maximum frequency when the FX3 compatible function is valid

Shown below is the assignment of the high-speed counter and the maximum frequency when the FX3 compatible function is valid.

CH	High-speed counter No.	FX5 corresponding devices	X0	X1	X2	X3	X4	X5	X6	X7	Maximum frequency		
											FX5UJ CPU module	FX5U/FX5UC CPU module (32 points type)	FX5U/FX5UC CPU module (64 points or more type)
CH1	C235	LC35	A								100 kHz	200 kHz	200 kHz
CH2	C236	LC36		A							100 kHz	200 kHz	200 kHz
CH3	C237	LC37			A						10 kHz	200 kHz	200 kHz
CH4	C238	LC38				A					100 kHz	200 kHz	200 kHz
CH5	C239	LC39					A				100 kHz	200 kHz	200 kHz
CH6	C240	LC40						A			10 kHz	200 kHz	200 kHz
CH1	C241	LC41	A	P							100 kHz	200 kHz	200 kHz
CH3	C242	LC42			A	P					10 kHz	200 kHz	200 kHz
CH5	C243	LC43					A	P			100 kHz	200 kHz	200 kHz
CH1	C244	LC44	A	P					E		100 kHz	200 kHz	200 kHz
CH7	C244 (OP)	LC44							A		10 kHz	10 kHz	200 kHz
CH3	C245	LC45			A	P				E	10 kHz	200 kHz	200 kHz
CH8	C245 (OP)	LC45								A	10 kHz	10 kHz	200 kHz
CH1	C246	LC46	A	B							100 kHz	200 kHz	200 kHz
CH1	C247	LC47	A	B	P						100 kHz	200 kHz	200 kHz
CH4	C248	LC48				A	B	P			100 kHz	200 kHz	200 kHz
CH4	C248 (OP)	LC48				A	B				100 kHz	200 kHz	200 kHz
CH1	C249	LC49	A	B	P				E		100 kHz	200 kHz	200 kHz
CH4	C250	LC50				A	B	P		E	100 kHz	200 kHz	200 kHz
CH1	C251 (1 edge count)	LC51	A	B							100 kHz	200 kHz	200 kHz
CH1	C251 (4 edge count)	LC51	A	B							25 kHz	50 kHz	50 kHz
CH1	C252 (1 edge count)	LC52	A	B	P						100 kHz	200 kHz	200 kHz
CH1	C252 (4 edge count)	LC52	A	B	P						25 kHz	50 kHz	50 kHz
CH4	C253 (1 edge count)	LC53				A	B	P			100 kHz	200 kHz	200 kHz
CH4	C253 (4 edge count)	LC53				A	B	P			25 kHz	50 kHz	50 kHz
CH4	C253 (OP) (1 edge count)	LC53				A	B				100 kHz	200 kHz	200 kHz
CH4	C253 (OP) (4 edge count)	LC53				A	B				25 kHz	50 kHz	50 kHz
CH1	C254 (1 edge count)	LC54	A	B	P				E		100 kHz	200 kHz	200 kHz
CH1	C254 (4 edge count)	LC54	A	B	P				E		25 kHz	50 kHz	50 kHz
CH7	C254 (OP)	LC54							A	B	10 kHz	10 kHz	200 kHz
CH4	C255 (1 edge count)	LC55				A	B	P		E	100 kHz	200 kHz	200 kHz
CH4	C255 (4 edge count)	LC55				A	B	P		E	25 kHz	50 kHz	50 kHz

A: Input A phase, B: Input A phase, P: Input external preset, E: Input external enable

FX3-compatible high-speed counter setting

This section describes the setting of the case when the FX3 compatible high-speed counter is used.

FX3-compatible high-speed counter are set by GX Works3.





Point

- If a high-speed comparison table or a multi-point output high-speed comparison table is used, it is necessary to set the parameter in the same manner as the FX5 high-speed counter.
- It is necessary to specify also the input response time.

Parameter setting

FX3-compatible high-speed counter parameter setting method is explained below.

For parameter setting of each operation, refer to the following.

- For FX3-compatible high-speed counters, refer to  Page 297 FX3-compatible high-speed counter.
- For high-speed comparison table, refer to  Page 244 High-speed comparison table.
- For multiple point output, high-speed comparison tables, refer to  Page 247 Multiple point output, high-speed comparison tables.
- For input response time, refer to  Page 329 General-purpose Input Functions.

FX3-compatible high-speed counter

FX3 compatible high-speed counter setting method is explained below.

1. Set the method of specifying the high-speed counter to "long counter setting".

 Navigation window ⇒ [Parameter] ⇒ [FX5UJCPU] or [FX5UCPU] ⇒ [Module Parameter] ⇒ [High Speed I/O] ⇒ "Input Function" ⇒ "High Speed Counter" ⇒ "Detail Setting" ⇒ "Other"

Window

Item	CH
Specification method for high speed counter	Select the high-speed counter for the FX3 series compatible input assignment.
Specification method for high speed counter	Long Counter Specification

Displayed items

Item	Description	Setting range	Default
Specification method for high speed counter	Set up whether or not to use FX3 compatibility assignment for high speed counter. <ul style="list-style-type: none"> • When using FX5 high-speed counter, choose "normal". • When using FX3 compatible high-speed counter, choose "long counter specification". 	<ul style="list-style-type: none"> • Normal • Long Counter Specification 	Normal

2. Set up the FX3 compatible high-speed counter.

The counter number and function that can be specified are different from CH to CH. ( Page 295 Assignment for FX3-compatible high-speed counters)

 Navigation window ⇒ [Parameter] ⇒ [FX5UJCPU] or [FX5UCPU] ⇒ [Module Parameter] ⇒ [High Speed I/O] ⇒ "Input Function" ⇒ "High Speed Counter" ⇒ "Detail Setting" ⇒ "Basic Settings"

Window

Item	CH1	CH2	CH3
Use/Do Not Use Counter	Set whether to use counter or not.		
Use/Not Use	Enable	Enable	Enable
Counter device	Select the high-speed counter for the FX3 series compatible input assignment.		
Counter device	LC35 (Operation equivalent to C235)	LC36 (Operation equivalent to C236)	LC37 (Operation equivalent to C237)
Operation Mode	Set operation mode.		
Operation Mode	Normal Mode	Normal Mode	Normal Mode
Pulse Input Mode	Set pulse input mode.		
Pulse Input Mode	1-Phase 1 Input (S/W Up/Down Switch)	1-Phase 1 Input (S/W Up/Down Switch)	1-Phase 1 Input (S/W Up/Down Switch)
Preset Input	Set preset input.		
Preset Input Enable/Disable	Disable	Disable	Disable
Input logic	Positive Logic	Positive Logic	Positive Logic
Preset Value	0	0	0
Input Comparison Enable/Disable	Enable	Enable	Disable
Control Switch	Rising	Rising + Falling Edge	Falling
Enable Input	Set enable input.		
Enable Input Enable/Disable	Disable	Disable	Disable
Input logic	Positive Logic	Positive Logic	Positive Logic
Ring Length Setting	Set ring length.		
Ring Length Enable/Disable	Disable	Disable	Disable
Ring Length	2147483648	2147483648	2147483648
Measurement Unit Time	Set the measurement unit time (ms) for the pulse density measurement mode and rotation speed measurement mode.		
Measurement Unit Time	1000	1000	1000
No. of Pulse per Rotation	Set the number of pulses per rotation when using the rotation speed measurement mode.		
No. of Pulse per Rotation	1000	1000	1000

Displayed items

Item	Description	Setting range	Default																
Use/Not Use	Set whether use counter or not.	<ul style="list-style-type: none"> • Disable • Enable 	—																
Counter device	Select the high speed counter of input assignment which is compatible with FX3.	<table border="0"> <tr> <td>CH1</td> <td> <ul style="list-style-type: none"> • LC35 (Operation equivalent to C235) • LC41 (Operation equivalent to C241) • LC44 (Operation equivalent to C244) • LC46 (Operation equivalent to C246) • LC47 (Operation equivalent to C247) • LC49 (Operation equivalent to C249) • LC51 (Operation equivalent to C251) • LC52 (Operation equivalent to C252) • LC54 (Operation equivalent to C254) </td> </tr> <tr> <td>CH2</td> <td> <ul style="list-style-type: none"> • LC36 (Operation equivalent to C236) </td> </tr> <tr> <td>CH3</td> <td> <ul style="list-style-type: none"> • LC37 (Operation equivalent to C237) • LC42 (Operation equivalent to C242) • LC45 (Operation equivalent to C245) </td> </tr> <tr> <td>CH4</td> <td> <ul style="list-style-type: none"> • LC38 (Operation equivalent to C238) • LC48 (Operation equivalent to C248) • LC50 (Operation equivalent to C250) • LC53 (Operation equivalent to C253) • LC55 (Operation equivalent to C255) • LC48 (Operation equivalent to C248(OP)) • LC53 (Operation equivalent to C253(OP)) </td> </tr> <tr> <td>CH5</td> <td> <ul style="list-style-type: none"> • LC39 (Operation equivalent to C239) • LC43 (Operation equivalent to C243) </td> </tr> <tr> <td>CH6</td> <td> <ul style="list-style-type: none"> • LC40 (Operation equivalent to C240) </td> </tr> <tr> <td>CH7</td> <td> <ul style="list-style-type: none"> • LC44 (Operation equivalent to C244(OP)) • LC54 (Operation equivalent to C254(OP)) </td> </tr> <tr> <td>CH8</td> <td> <ul style="list-style-type: none"> • LC45 (Operation equivalent to C245) </td> </tr> </table>	CH1	<ul style="list-style-type: none"> • LC35 (Operation equivalent to C235) • LC41 (Operation equivalent to C241) • LC44 (Operation equivalent to C244) • LC46 (Operation equivalent to C246) • LC47 (Operation equivalent to C247) • LC49 (Operation equivalent to C249) • LC51 (Operation equivalent to C251) • LC52 (Operation equivalent to C252) • LC54 (Operation equivalent to C254) 	CH2	<ul style="list-style-type: none"> • LC36 (Operation equivalent to C236) 	CH3	<ul style="list-style-type: none"> • LC37 (Operation equivalent to C237) • LC42 (Operation equivalent to C242) • LC45 (Operation equivalent to C245) 	CH4	<ul style="list-style-type: none"> • LC38 (Operation equivalent to C238) • LC48 (Operation equivalent to C248) • LC50 (Operation equivalent to C250) • LC53 (Operation equivalent to C253) • LC55 (Operation equivalent to C255) • LC48 (Operation equivalent to C248(OP)) • LC53 (Operation equivalent to C253(OP)) 	CH5	<ul style="list-style-type: none"> • LC39 (Operation equivalent to C239) • LC43 (Operation equivalent to C243) 	CH6	<ul style="list-style-type: none"> • LC40 (Operation equivalent to C240) 	CH7	<ul style="list-style-type: none"> • LC44 (Operation equivalent to C244(OP)) • LC54 (Operation equivalent to C254(OP)) 	CH8	<ul style="list-style-type: none"> • LC45 (Operation equivalent to C245) 	—
CH1	<ul style="list-style-type: none"> • LC35 (Operation equivalent to C235) • LC41 (Operation equivalent to C241) • LC44 (Operation equivalent to C244) • LC46 (Operation equivalent to C246) • LC47 (Operation equivalent to C247) • LC49 (Operation equivalent to C249) • LC51 (Operation equivalent to C251) • LC52 (Operation equivalent to C252) • LC54 (Operation equivalent to C254) 																		
CH2	<ul style="list-style-type: none"> • LC36 (Operation equivalent to C236) 																		
CH3	<ul style="list-style-type: none"> • LC37 (Operation equivalent to C237) • LC42 (Operation equivalent to C242) • LC45 (Operation equivalent to C245) 																		
CH4	<ul style="list-style-type: none"> • LC38 (Operation equivalent to C238) • LC48 (Operation equivalent to C248) • LC50 (Operation equivalent to C250) • LC53 (Operation equivalent to C253) • LC55 (Operation equivalent to C255) • LC48 (Operation equivalent to C248(OP)) • LC53 (Operation equivalent to C253(OP)) 																		
CH5	<ul style="list-style-type: none"> • LC39 (Operation equivalent to C239) • LC43 (Operation equivalent to C243) 																		
CH6	<ul style="list-style-type: none"> • LC40 (Operation equivalent to C240) 																		
CH7	<ul style="list-style-type: none"> • LC44 (Operation equivalent to C244(OP)) • LC54 (Operation equivalent to C254(OP)) 																		
CH8	<ul style="list-style-type: none"> • LC45 (Operation equivalent to C245) 																		
Operation Mode	Not available for FX3-compatible high-speed counters.	—	—																
Pulse Input Mode	Set pulse input mode.	<ul style="list-style-type: none"> • 2 Phase 1 Multiple • 2 Phase 4 Multiple 	—																
Preset Input Enable/Disable	Not available for FX3-compatible high-speed counters	—	—																
Input logic	Sets preset input logic when preset input is enabled.	<ul style="list-style-type: none"> • Positive Logic • Negative Logic 	—																

Item	Description	Setting range	Default
Preset Value	Sets preset input logic when preset input is enabled.	—	—
Input Comparison Enable/Disable	Sets whether to "enable" or "disable" input comparison when preset input is enabled.	<ul style="list-style-type: none"> • Disable • Enable 	—
Control Switch	Sets preset execution timing when preset input is enabled.	<ul style="list-style-type: none"> • Rising • Falling • Rising + Falling Edge • Always During Input ON 	—
Enable Input Enable/Disable	Not available for FX3-compatible high-speed counters	—	—
Input logic			
Ring Length Enable/Disable			
Ring Length			
Measurement Unit Time			
No. of Pulse per Rotation			

Point

Parameters are enabled when the CPU module is powered ON or after a reset.

Special relay list

A list of special relays used for high-speed counters is provided below.

Only the special relay corresponding to the LC device used as the high-speed counter operates when the FX3 compatible high-speed counter function is valid.

The special relay/special registers other than those described in the list below operates in the same manner as when the FX3 compatible high-speed counter function is not valid.

Special relay	Function	Operation		Default	R/W
		ON	OFF		
SM8246	LC46 counting direction monitoring	Down-counting	Up-counting	OFF	R
SM8247	LC47 counting direction monitoring	Down-counting	Up-counting	OFF	R
SM8248	LC48 counting direction monitoring	Down-counting	Up-counting	OFF	R
SM8249	LC49 counting direction monitoring	Down-counting	Up-counting	OFF	R
SM8250	LC50 counting direction monitoring	Down-counting	Up-counting	OFF	R
SM8251	LC51 counting direction monitoring	Down-counting	Up-counting	OFF	R
SM8252	LC52 counting direction monitoring	Down-counting	Up-counting	OFF	R
SM8253	LC53 counting direction monitoring	Down-counting	Up-counting	OFF	R
SM8254	LC54 counting direction monitoring	Down-counting	Up-counting	OFF	R
SM8255	LC55 counting direction monitoring	Down-counting	Up-counting	OFF	R

LC□ count direction monitor

This is the device to monitor the directions of the counters from LC46 to LC55 when the FX3 compatible high-speed counter is used.

■ Operation Description

The content of the operation when ON and when OFF is as follows.

Operation when ON	Operation when OFF
High-speed counter counting in direction whereby current value is reduced (Down-counting)	High-speed counter counting in direction whereby current value is increased (Up-counting)

■ Update timing

The timing of device update is as follows.

ON	OFF
Down-counting (This is updated with the END processing. When the FX3 compatible high-speed counter function is valid, the updating is made also when UDCNTF instruction is executed ON.)	<ul style="list-style-type: none"> • Up-counting (This is updated with the END processing. When the FX3 compatible high-speed counter function is valid, the updating is made also when UDCNTF instruction is executed ON.) • Power ON, reset • STOP/PAUSE→RUN

Special relays/LC devices capable of high-speed transfers with the HCMOV/DHCMOV instruction

Shown below are the special relay/LC device that can read and write the latest value with the HCMOV/DHCMOV instruction when the FX3 compatible high-speed counter function is valid. When special relays and special registers are specified for (s) and (d) of instructions other than the HCMOV/DHCMOV instruction, the operation is the same as one compatible with the MOV/DMOV instruction.

The same operation as when the FX3 compatible high-speed counter is not valid is made for the special relay/special register capable of high-speed transfers with the HCMOV/DHCMOV instruction other than those described in the list below.

Special relay

○: High-speed transfer capable (special relay is immediately updated)

△: Normal transfer capable (special relay is updated in END processing)

×: Transfer not possible (read-only)

Special relay	Function	Compatible with HCMOV/DHCMOV instruction		Compatible with MOV/DMOV instruction	
		(s)	(d)	(s)	(d)
SM8246	LC46 counting direction monitoring	○	×	△	×
SM8247	LC47 counting direction monitoring	○	×	△	×
SM8248	LC48 counting direction monitoring	○	×	△	×
SM8249	LC49 counting direction monitoring	○	×	△	×
SM8250	LC50 counting direction monitoring	○	×	△	×
SM8251	LC51 counting direction monitoring	○	×	△	×
SM8252	LC52 counting direction monitoring	○	×	△	×
SM8253	LC53 counting direction monitoring	○	×	△	×
SM8254	LC54 counting direction monitoring	○	×	△	×
SM8255	LC55 counting direction monitoring	○	×	△	×

LC device

- : High-speed transfer capable (special relay is immediately updated)
- △: Normal transfer capable (special relay is updated in END processing)
- ×: Transfer not possible (read-only)

LC device	Function	Compatible with DHCMOV instruction		Compatible with DMOV instruction	
		(s)	(d)	(s)	(d)
LC35	High-speed counter current value (CH1)	○	○	△	×
LC36	High-speed counter current value (CH2)	○	○	△	×
LC37	High-speed counter current value (CH3)	○	○	△	×
LC38	High-speed counter current value (CH4)	○	○	△	×
LC39	High-speed counter current value (CH5)	○	○	△	×
LC40	High-speed counter current value (CH6)	○	○	△	×
LC41	High-speed counter current value (CH1)	○	○	△	×
LC42	High-speed counter current value (CH3)	○	○	△	×
LC43	High-speed counter current value (CH5)	○	○	△	×
LC44	High-speed counter current value (CH1)/High-speed counter current value (CH7)	○	○	△	×
LC45	High-speed counter current value (CH3)/High-speed counter current value (CH8)	○	○	△	×
LC46	High-speed counter current value (CH1)	○	○	△	×
LC47	High-speed counter current value (CH1)	○	○	△	×
LC48	High-speed counter current value (CH4)	○	○	△	×
LC49	High-speed counter current value (CH1)	○	○	△	×
LC50	High-speed counter current value (CH4)	○	○	△	×
LC51	High-speed counter current value (CH1)	○	○	△	×
LC52	High-speed counter current value (CH1)	○	○	△	×
LC53	High-speed counter current value (CH4)	○	○	△	×
LC54	High-speed counter current value (CH1)/High-speed counter current value (CH7)	○	○	△	×
LC55	High-speed counter current value (CH4)	○	○	△	×

Precautions when using FX3-compatible high-speed counters

Shown below are the precautions for using the FX3 compatible high-speed counter. For any other precautions, see the precautions for each function.

- When the FX3 compatible function is valid, it is possible to specify the LC device in (s1) of the DHSCS instruction/DHSCR instruction and (s) of the DHSZ instruction. If an LC device that is not used as high-speed counter is specified, an error occurs, and the DHSCS instruction, the DHSCR instruction, and the DHSZ instruction do not operate.
- Set up the table with the CH number of the counter if the table number of the high-speed comparison table/the multi-point output high-speed comparison table needs to be specified.
- To clear the current value of the LC device, use the DHCMOV instruction or the RST instruction to clear it.
- Use the latch setting to use LC35 to LC55 with the high-speed counter of the FX3 compatible function.
- The reset coil of the LC device is cleared when the power is set from OFF to ON.
- For the functions that share inputs with FX3-compatible high-speed counter function, refer to  Page 288 Functions that share inputs and outputs.

26.3 Pulse Width Measurement Function

This section describes the pulse width measurement function.

Pulse width measurement function overview

Pulse width/period measurement of up to 12 channels is possible from the CPU module and the high-speed pulse input/output module. The pulse width/period measurement function stores the values of 0.5 μ s ring counters at the input signal rising edge and falling edge to special data registers. This function also stores the difference in the counter values (pulse width) between the rising edge and the falling edge or stores the difference in the counter values (cycle) between the previous rising edge and the current rising edge to special data registers in units of 0.5 μ s.

For the pulse width measurement function, input channel assignments, logical switch, and measurement mode settings are configured with parameters, and measurements are started/stopped using the HIOEN/DHIOEN instruction.

High-speed pulse input/output module is supported only for FX5U/FX5UC CPU module.

Point

To use the pulse width measurement function, parameter settings and the HIOEN/DHIOEN instruction are always required.

Pulse width measurement specifications

This section describes the pulse width measurement function specifications.

Pulse input signals

■FX5UJ CPU module

Pulse width measurements can be used for a maximum of 4 channels.

The input device assignment is as follows. (fixed)

CPU module			
CH1	CH2	CH3	CH4
X0	X1	X2	X4

The table below shows the measurement frequencies.

CPU module	Measurement frequencies
X0, X1, X3, X4	100 kHz

The table below shows the measurement precision.

Item	Description	
Possible measurement range	Cycle	10 μ s
	Pulse width	10 μ s
Maximum measurable signal width	1073s741ms823 μ s	
Resolution	0.5 μ s	

■FX5U/FX5UC CPU module and high-speed pulse input/output module

Pulse width measurements can be used for a maximum of 12 channels. (CPU module 4CH + high-speed pulse input/output module 2CH × 4 units)

The input device assignment is as follows.

CPU module				High-speed pulse input/output module*1							
				First module		Second module		Third module		Fourth module	
CH1	CH2	CH3	CH4	CH5	CH6	CH7	CH8	CH9	CH10	CH11	CH12
X0 to X7 (Any device can be set.)				X□+3	X□+4	X□+3	X□+4	X□+3	X□+4	X□+3	X□+4

*1 □: Head input number for each high-speed pulse input/output module

The table below shows the measurement frequencies.

FX5U-32M□, FX5UC-32M□	FX5U-64M□, FX5U-80M□, FX5UC-64M□, FX5UC-96M□	High-speed pulse input/output module*2	Measurement frequencies
X0 to X5	X0 to X7	X□+3, X□+4	200 kHz
X6 to X7	—	—	10 kHz

*2 □: Head input number for each high-speed pulse input/output module

The table below shows the measurement precision.

Item	Description	
Possible measurement range	Cycle	5 μs
	Pulse width	5 μs
Maximum measurable signal width	1073s741ms823μs	
Resolution	0.5 μs	

Pulse measurements

The pulse width and period are stored in special devices by the END instruction. (☞ Page 307 List of special relays/special registers)

Pulse width maximum value and minimum value

The maximum value and minimum value of the pulse width from the start of measurements are stored in special devices.

(☞ Page 307 List of special relays/special registers)

Period maximum value and minimum value

The maximum value and minimum value of the period from the start of measurements are stored in special devices.

(☞ Page 307 List of special relays/special registers)

Switching positive logic/negative logic

The pulse input logic can be switched.

Positive logic or negative logic can be set for each channel with parameter settings.

■ Operation for positive logic

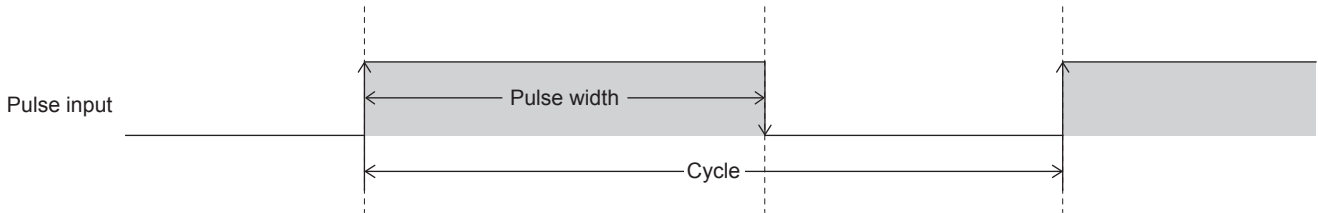

■ Operation for negative logic

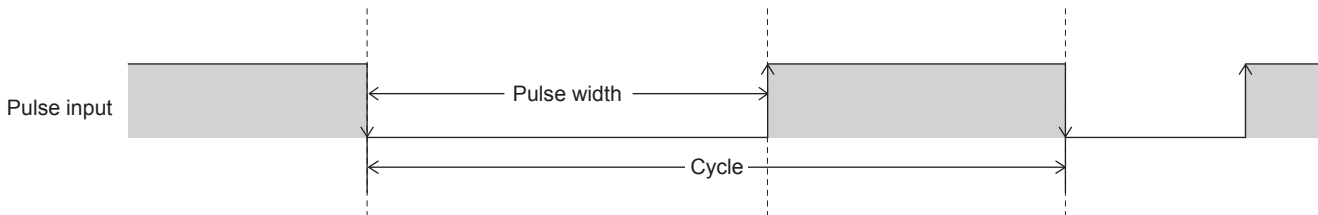

Continuous measurement/one-time measurement mode

The pulse width measurement mode can be set.

The table below shows the measurement modes for pulse width measurements.

Mode	Description
1 time measurement mode	Measures the pulse width and period only once from the start of the measurement.
Always measurement mode	Constantly measures the pulse width and period.

Point

The measurement mode can be changed by using a special relay. ( Page 313 Measurement mode)

Signal delay time measurement

In a user program, the delay time between signals can be calculated from the rising or falling ring counters of 2 inputs.

( Page 318 Examples of program)

Pulse measurement function execution procedure

The pulse measurement function execution procedure is shown below.

1. Check the pulse measurement specifications.

Check the specifications such as the measurement frequency of pulse measurements. (☞ Page 302 Pulse width measurement specifications)

2. Connect the CPU module to the external device.

For details on wiring to external devices, refer to the following manual

📖 MELSEC iQ-F FX5UJ User's Manual (Hardware)

📖 MELSEC iQ-F FX5U User's Manual (Hardware)

📖 MELSEC iQ-F FX5UC User's Manual (Hardware)

3. Set the parameters.

Configure the parameters such as the pulse measurement channel settings. (☞ Page 305 Pulse width measurement parameters)

4. Create the program.

Create the program for using pulse measurements.

5. Run the program.

Pulse width measurement parameters

This section explains the parameters for pulse width measurement.

Set the parameters for pulse width measurement in GX Works3.

Outline of parameters

Parameters for pulse width measurement are input allocation, logical switch, measurement modes and input response time.

Parameter setting

The following explains how to set the parameters for pulse width measurement.

For input response time, refer to ☞ Page 329 General-purpose Input Functions.

■ CPU module

🔗 Navigation window ⇒ [Parameter] ⇒ [FX5UJCPU] or [FX5UCPU] ⇒ [Module Parameter] ⇒ [High Speed I/O] ⇒ "Input Function" ⇒ "Pulse Width Measurement" ⇒ "Detail Setting"

Window

Item	CH1	CH2	CH3	CH4
Use Pulse Width Measurement	Set whether to use pulse width measurement or not.			
Use/Not Use	Enable	Enable	Enable	Disable
Input Signal	Set input signal.			
Input Signal	X0	X1	X3	X0
Switch Logic	Set switching logic.			
Switch Logic	Positive Logic	Negative Logic	Positive Logic	Positive Logic
Measurement Mode	Set measurement mode.			
Measurement Mode	Always Measurement Mode	1 Time Measurement Mode	1 Time Measurement Mode	Always Measurement Mode

Displayed items

Item	Description	Setting range	Default
Use Pulse Width Measurement	Set whether to use pulse width measurement or not.	<ul style="list-style-type: none"> • Disable • Enable 	Disable
Input Signal	Set input signal.	<ul style="list-style-type: none"> ■FX5UJ CPU module CH1 (X0), CH2 (X1), CH3 (X3), CH4 (X4) ■FX5U/FX5UC CPU module X0 to X7 	—
Logical Switch	Set logical switch.	<ul style="list-style-type: none"> • Positive Logic • Negative Logic 	—
Measurement Mode	Set measurement mode.	<ul style="list-style-type: none"> • Always Measurement Mode • 1 Time Measurement Mode 	—

■High-speed pulse input/output module

Add the high-speed pulse input/output module.

Navigation window ⇒ [Parameter] ⇒ [Module Information] ⇒ Right-click ⇒ Add New Module

After adding the high-speed pulse input/output module, make settings on the the screen displayed from the following operation.

Navigation window ⇒ [Parameter] ⇒ [Module Information] ⇒ [1 to 16 (high-speed pulse input/output module)] ⇒ [Module Parameter] ⇒ [High Speed I/O] ⇒ "Input Function" ⇒ "Pulse Width Measurement" ⇒ "Detailed Setting"

Window

Item	CH5	CH6
Use Pulse Width Measurement	Set whether to use pulse width measurement or not.	
Use/Not Use	Enable	Enable
Input Signal	Set input signal.	
Input Signal	X23	X24
Switch Logic	Set switching logic.	
Switch Logic	Positive Logic	Negative Logic
Measurement Mode	Set measurement mode.	
Measurement Mode	Always Measurement Mode	1 Time Measurement Mode

Shown above is the screen at the time when the first high-speed pulse input/output module is selected.

Displayed items

Item	Description	Setting range	Default
Use Pulse Width Measurement	Set whether to use pulse width measurement or not.	<ul style="list-style-type: none"> • Disable • Enable 	Disable
Input Signal	Use input signal. The input number is fixed for each channel.	<ul style="list-style-type: none"> • CH□: X■+3^{*1} • CH□+1: X■+4^{*1} 	—
Logical Switch	Set logical switch.	<ul style="list-style-type: none"> • Positive Logic • Negative Logic 	—
Measurement Mode	Set measurement mode.	<ul style="list-style-type: none"> • Always Measurement Mode • 1 Time Measurement Mode 	—

*1 The number in □ is first module: 5, second module: 7, third module: 9, fourth module: 11.

The number in ■ is the head input number for each high-speed pulse input/output module.

Point

The items specified in the parameters are stored in special devices when the CPU module is set from STOP to RUN.

List of special relays/special registers

The list of special relays/special registers used in pulse width measurement is shown below.

○: Supported, ×: Not supported

R: Read only, R/W: Read or write (Note, however, that only writing is allowed for the HCMOV/DHCMOV instruction.)

Special relays/ special registers	Function	Description	Default	Function support		R/W
				FX5UJ	FX5U/ FX5UC	
SM5020	CH1 pulse width measurement status flag	The measurement in progress/measurement stopped status of pulse width measurement on the target channel can be checked by these flags. OFF: Measurement stopped ON: Measurement in progress	OFF	○	○	R
SM5021	CH2 pulse width measurement status flag			○	○	
SM5022	CH3 pulse width measurement status flag			○	○	
SM5023	CH4 pulse width measurement status flag			○	○	
SM5024	CH5 pulse width measurement status flag			×	○	
SM5025	CH6 pulse width measurement status flag			×	○	
SM5026	CH7 pulse width measurement status flag			×	○	
SM5027	CH8 pulse width measurement status flag			×	○	
SM5028	CH9 pulse width measurement status flag			×	○	
SM5029	CH10 pulse width measurement status flag			×	○	
SM5030	CH11 pulse width measurement status flag			×	○	
SM5031	CH12 pulse width measurement status flag			×	○	
SM5036	CH1 period measurement complete			These flags turn ON at the end of the 1st period measurement on the target channel. (They remain ON during measurement in the always measurement mode.)	OFF	
SM5037	CH2 period measurement complete	○	○			
SM5038	CH3 period measurement complete	○	○			
SM5039	CH4 period measurement complete	○	○			
SM5040	CH5 period measurement complete	×	○			
SM5041	CH6 period measurement complete	×	○			
SM5042	CH7 period measurement complete	×	○			
SM5043	CH8 period measurement complete	×	○			
SM5044	CH9 period measurement complete	×	○			
SM5045	CH10 period measurement complete	×	○			
SM5046	CH11 period measurement complete	×	○			
SM5047	CH12 period measurement complete	×	○			
SM5052	CH1 pulse width measurement complete	These flags turn ON at the end of the 1st pulse width measurement on the target channel. (They remain ON during measurement in the always measurement mode.)	OFF	○	○	R
SM5053	CH2 pulse width measurement complete			○	○	
SM5054	CH3 pulse width measurement complete			○	○	
SM5055	CH4 pulse width measurement complete			○	○	
SM5056	CH5 pulse width measurement complete			×	○	
SM5057	CH6 pulse width measurement complete			×	○	
SM5058	CH7 pulse width measurement complete			×	○	
SM5059	CH8 pulse width measurement complete			×	○	
SM5060	CH9 pulse width measurement complete			×	○	
SM5061	CH10 pulse width measurement complete			×	○	
SM5062	CH11 pulse width measurement complete			×	○	
SM5063	CH12 pulse width measurement complete			×	○	

Special relays/ special registers	Function	Description	Default	Function support		R/W
				FX5UJ	FX5U/ FX5UC	
SM5068	CH1 measurement mode	The measurement mode of the target channel can be checked by these flags. (To change the measurement mode during operation, use this special relay.) OFF: Always measurement mode ON: 1 time measurement mode	ON	<input type="radio"/>	<input type="radio"/>	R/W ^{*1}
SM5069	CH2 measurement mode			<input type="radio"/>	<input type="radio"/>	
SM5070	CH3 measurement mode			<input type="radio"/>	<input type="radio"/>	
SM5071	CH4 measurement mode			<input type="radio"/>	<input type="radio"/>	
SM5072	CH5 measurement mode			<input checked="" type="radio"/>	<input type="radio"/>	
SM5073	CH6 measurement mode			<input checked="" type="radio"/>	<input type="radio"/>	
SM5074	CH7 measurement mode			<input checked="" type="radio"/>	<input type="radio"/>	
SM5075	CH8 measurement mode			<input checked="" type="radio"/>	<input type="radio"/>	
SM5076	CH9 measurement mode			<input checked="" type="radio"/>	<input type="radio"/>	
SM5077	CH10 measurement mode			<input checked="" type="radio"/>	<input type="radio"/>	
SM5078	CH11 measurement mode			<input checked="" type="radio"/>	<input type="radio"/>	
SM5079	CH12 measurement mode			<input checked="" type="radio"/>	<input type="radio"/>	
SD5021, SD5020	CH1 rising edge ring counter value	The ring counter value when the rising edge is detected is stored.	00000000H	<input type="radio"/>	<input type="radio"/>	R
SD5023, SD5022	CH1 falling edge ring counter value	The ring counter value when the falling edge is detected is stored.	00000000H	<input type="radio"/>	<input type="radio"/>	R
SD5025, SD5024	CH1 pulse width latest value	The latest value of the pulse width is stored.	00000000H	<input type="radio"/>	<input type="radio"/>	R
SD5027, SD5026	CH1 pulse width maximum value	The maximum value of the pulse width is stored.	00000000H	<input type="radio"/>	<input type="radio"/>	R/W
SD5029, SD5028	CH1 pulse width minimum value	The minimum value of the pulse width is stored.	FFFFFFFFH	<input type="radio"/>	<input type="radio"/>	R/W
SD5031, SD5030	CH1 period latest value	The latest value of the period is stored.	00000000H	<input type="radio"/>	<input type="radio"/>	R
SD5033, SD5032	CH1 period maximum value	The maximum value of the period is stored.	00000000H	<input type="radio"/>	<input type="radio"/>	R/W
SD5035, SD5034	CH1 period minimum value	The minimum value of the period is stored.	FFFFFFFFH	<input type="radio"/>	<input type="radio"/>	R/W
SD5041, SD5040	CH2 rising edge ring counter value	The ring counter value when the rising edge is detected is stored.	00000000H	<input type="radio"/>	<input type="radio"/>	R
SD5043, SD5042	CH2 falling edge ring counter value	The ring counter value when the falling edge is detected is stored.	00000000H	<input type="radio"/>	<input type="radio"/>	R
SD5045, SD5044	CH2 pulse width latest value	The latest value of the pulse width is stored.	00000000H	<input type="radio"/>	<input type="radio"/>	R
SD5047, SD5046	CH2 pulse width maximum value	The maximum value of the pulse width is stored.	00000000H	<input type="radio"/>	<input type="radio"/>	R/W
SD5049, SD5048	CH2 pulse width minimum value	The minimum value of the pulse width is stored.	FFFFFFFFH	<input type="radio"/>	<input type="radio"/>	R/W
SD5051, SD5050	CH2 period latest value	The latest value of the period is stored.	00000000H	<input type="radio"/>	<input type="radio"/>	R
SD5053, SD5052	CH2 period maximum value	The maximum value of the period is stored.	00000000H	<input type="radio"/>	<input type="radio"/>	R/W
SD5055, SD5054	CH2 period minimum value	The minimum value of the period is stored.	FFFFFFFFH	<input type="radio"/>	<input type="radio"/>	R/W
SD5061, SD5060	CH3 rising edge ring counter value	The ring counter value when the rising edge is detected is stored.	00000000H	<input type="radio"/>	<input type="radio"/>	R
SD5063, SD5062	CH3 falling edge ring counter value	The ring counter value when the falling edge is detected is stored.	00000000H	<input type="radio"/>	<input type="radio"/>	R
SD5065, SD5064	CH3 pulse width latest value	The latest value of the pulse width is stored.	00000000H	<input type="radio"/>	<input type="radio"/>	R
SD5067, SD5066	CH3 pulse width maximum value	The maximum value of the pulse width is stored.	00000000H	<input type="radio"/>	<input type="radio"/>	R/W
SD5069, SD5068	CH3 pulse width minimum value	The minimum value of the pulse width is stored.	FFFFFFFFH	<input type="radio"/>	<input type="radio"/>	R/W
SD5071, SD5070	CH3 period latest value	The latest value of the period is stored.	00000000H	<input type="radio"/>	<input type="radio"/>	R

Special relays/ special registers	Function	Description	Default	Function support		R/W
				FX5UJ	FX5U/ FX5UC	
SD5073, SD5072	CH3 period maximum value	The maximum value of the period is stored.	00000000H	○	○	R/W
SD5075, SD5074	CH3 period minimum value	The minimum value of the period is stored.	FFFFFFFFH	○	○	R/W
SD5081, SD5080	CH4 rising edge ring counter value	The ring counter value when the rising edge is detected is stored.	00000000H	○	○	R
SD5083, SD5082	CH4 falling edge ring counter value	The ring counter value when the falling edge is detected is stored.	00000000H	○	○	R
SD5085, SD5084	CH4 pulse width latest value	The latest value of the pulse width is stored.	00000000H	○	○	R
SD5087, SD5086	CH4 pulse width maximum value	The maximum value of the pulse width is stored.	00000000H	○	○	R/W
SD5089, SD5088	CH4 pulse width minimum value	The minimum value of the pulse width is stored.	FFFFFFFFH	○	○	R/W
SD5091, SD5090	CH4 period latest value	The latest value of the period is stored.	00000000H	○	○	R
SD5093, SD5092	CH4 period maximum value	The maximum value of the period is stored.	00000000H	○	○	R/W
SD5095, SD5094	CH4 period minimum value	The minimum value of the period is stored.	FFFFFFFFH	○	○	R/W
SD5101, SD5100	CH5 rising edge ring counter value	The ring counter value when the rising edge is detected is stored.	00000000H	×	○	R
SD5103, SD5102	CH5 falling edge ring counter value	The ring counter value when the falling edge is detected is stored.	00000000H	×	○	R
SD5105, SD5104	CH5 pulse width latest value	The latest value of the pulse width is stored.	00000000H	×	○	R
SD5107, SD5106	CH5 pulse width maximum value	The maximum value of the pulse width is stored.	00000000H	×	○	R/W
SD5109, SD5108	CH5 pulse width minimum value	The minimum value of the pulse width is stored.	FFFFFFFFH	×	○	R/W
SD5111, SD5110	CH5 period latest value	The latest value of the period is stored.	00000000H	×	○	R
SD5113, SD5112	CH5 period maximum value	The maximum value of the period is stored.	00000000H	×	○	R/W
SD5115, SD5114	CH5 period minimum value	The minimum value of the period is stored.	FFFFFFFFH	×	○	R/W
SD5121, SD5120	CH6 rising edge ring counter value	The ring counter value when the rising edge is detected is stored.	00000000H	×	○	R
SD5123, SD5122	CH6 falling edge ring counter value	The ring counter value when the falling edge is detected is stored.	00000000H	×	○	R
SD5125, SD5124	CH6 pulse width latest value	The latest value of the pulse width is stored.	00000000H	×	○	R
SD5127, SD5126	CH6 pulse width maximum value	The maximum value of the pulse width is stored.	00000000H	×	○	R/W
SD5129, SD5128	CH6 pulse width minimum value	The minimum value of the pulse width is stored.	FFFFFFFFH	×	○	R/W
SD5131, SD5130	CH6 period latest value	The latest value of the period is stored.	00000000H	×	○	R
SD5133, SD5132	CH6 period maximum value	The maximum value of the period is stored.	00000000H	×	○	R/W
SD5135, SD5134	CH6 period minimum value	The minimum value of the period is stored.	FFFFFFFFH	×	○	R/W
SD5141, SD5140	CH7 rising edge ring counter value	The ring counter value when the rising edge is detected is stored.	00000000H	×	○	R
SD5143, SD5142	CH7 falling edge ring counter value	The ring counter value when the falling edge is detected is stored.	00000000H	×	○	R
SD5145, SD5144	CH7 pulse width latest value	The latest value of the pulse width is stored.	00000000H	×	○	R

Special relays/ special registers	Function	Description	Default	Function support		R/W
				FX5UJ	FX5U/ FX5UC	
SD5147, SD5146	CH7 pulse width maximum value	The maximum value of the pulse width is stored.	00000000H	×	○	R/W
SD5149, SD5148	CH7 pulse width minimum value	The minimum value of the pulse width is stored.	FFFFFFFFH	×	○	R/W
SD5151, SD5150	CH7 period latest value	The latest value of the period is stored.	00000000H	×	○	R
SD5153, SD5152	CH7 period maximum value	The maximum value of the period is stored.	00000000H	×	○	R/W
SD5155, SD5154	CH7 period minimum value	The minimum value of the period is stored.	FFFFFFFFH	×	○	R/W
SD5161, SD5160	CH8 rising edge ring counter value	The ring counter value when the rising edge is detected is stored.	00000000H	×	○	R
SD5163, SD5162	CH8 falling edge ring counter value	The ring counter value when the falling edge is detected is stored.	00000000H	×	○	R
SD5165, SD5164	CH8 pulse width latest value	The latest value of the pulse width is stored.	00000000H	×	○	R
SD5167, SD5166	CH8 pulse width maximum value	The maximum value of the pulse width is stored.	00000000H	×	○	R/W
SD5169, SD5168	CH8 pulse width minimum value	The minimum value of the pulse width is stored.	FFFFFFFFH	×	○	R/W
SD5171, SD5170	CH8 period latest value	The latest value of the period is stored.	00000000H	×	○	R
SD5173, SD5172	CH8 period maximum value	The maximum value of the period is stored.	00000000H	×	○	R/W
SD5175, SD5174	CH8 period minimum value	The minimum value of the period is stored.	FFFFFFFFH	×	○	R/W
SD5181, SD5180	CH9 rising edge ring counter value	The ring counter value when the rising edge is detected is stored.	00000000H	×	○	R
SD5183, SD5182	CH9 falling edge ring counter value	The ring counter value when the falling edge is detected is stored.	00000000H	×	○	R
SD5185, SD5184	CH9 pulse width latest value	The latest value of the pulse width is stored.	00000000H	×	○	R
SD5187, SD5186	CH9 pulse width maximum value	The maximum value of the pulse width is stored.	00000000H	×	○	R/W
SD5189, SD5188	CH9 pulse width minimum value	The minimum value of the pulse width is stored.	FFFFFFFFH	×	○	R/W
SD5191, SD5190	CH9 period latest value	The latest value of the period is stored.	00000000H	×	○	R
SD5193, SD5192	CH9 period maximum value	The maximum value of the period is stored.	00000000H	×	○	R/W
SD5195, SD5194	CH9 period minimum value	The minimum value of the period is stored.	FFFFFFFFH	×	○	R/W
SD5201, SD5200	CH10 rising edge ring counter value	The ring counter value when the rising edge is detected is stored.	00000000H	×	○	R
SD5203, SD5202	CH10 falling edge ring counter value	The ring counter value when the falling edge is detected is stored.	00000000H	×	○	R
SD5205, SD5204	CH10 pulse width latest value	The latest value of the pulse width is stored.	00000000H	×	○	R
SD5207, SD5206	CH10 pulse width maximum value	The maximum value of the pulse width is stored.	00000000H	×	○	R/W
SD5209, SD5208	CH10 pulse width minimum value	The minimum value of the pulse width is stored.	FFFFFFFFH	×	○	R/W
SD5211, SD5210	CH10 period latest value	The latest value of the period is stored.	00000000H	×	○	R
SD5213, SD5212	CH10 period maximum value	The maximum value of the period is stored.	00000000H	×	○	R/W
SD5215, SD5214	CH10 period minimum value	The minimum value of the period is stored.	FFFFFFFFH	×	○	R/W

Special relays/ special registers	Function	Description	Default	Function support		R/W
				FX5UJ	FX5U/ FX5UC	
SD5221, SD5220	CH11 rising edge ring counter value	The ring counter value when the rising edge is detected is stored.	00000000H	×	○	R
SD5223, SD5222	CH11 falling edge ring counter value	The ring counter value when the falling edge is detected is stored.	00000000H	×	○	R
SD5225, SD5224	CH11 pulse width latest value	The latest value of the pulse width is stored.	00000000H	×	○	R
SD5227, SD5226	CH11 pulse width maximum value	The maximum value of the pulse width is stored.	00000000H	×	○	R/W
SD5229, SD5228	CH11 pulse width minimum value	The minimum value of the pulse width is stored.	FFFFFFFFH	×	○	R/W
SD5231, SD5230	CH11 period latest value	The latest value of the period is stored.	00000000H	×	○	R
SD5233, SD5232	CH11 period maximum value	The maximum value of the period is stored.	00000000H	×	○	R/W
SD5235, SD5234	CH11 period minimum value	The minimum value of the period is stored.	FFFFFFFFH	×	○	R/W
SD5241, SD5240	CH12 rising edge ring counter value	The ring counter value when the rising edge is detected is stored.	00000000H	×	○	R
SD5243, SD5242	CH12 falling edge ring counter value	The ring counter value when the falling edge is detected is stored.	00000000H	×	○	R
SD5245, SD5244	CH12 pulse width latest value	The latest value of the pulse width is stored.	00000000H	×	○	R
SD5247, SD5246	CH12 pulse width maximum value	The maximum value of the pulse width is stored.	00000000H	×	○	R/W
SD5249, SD5248	CH12 pulse width minimum value	The minimum value of the pulse width is stored.	FFFFFFFFH	×	○	R/W
SD5251, SD5250	CH12 period latest value	The latest value of the period is stored.	00000000H	×	○	R
SD5253, SD5252	CH12 period maximum value	The maximum value of the period is stored.	00000000H	×	○	R/W
SD5255, SD5254	CH12 period minimum value	The minimum value of the period is stored.	FFFFFFFFH	×	○	R/W

*1 Can be written to using instruction other than the HCMOV/DHCMOV instruction.

Details of special relays/special registers

Details of special relays/special registers used in pulse width measurement are explained below.

Pulse width measurement status flag

This flag is a device for monitoring the measurement in progress/measurement stopped status of pulse width measurement.

■Corresponding devices

The device numbers corresponding to each channel are as follows.

CPU module				High-speed pulse input/output module							
				First module		Second module		Third module		Fourth module	
CH1	CH2	CH3	CH4	CH5	CH6	CH7	CH8	CH9	CH10	CH11	CH12
SM5020	SM5021	SM5022	SM5023	SM5024	SM5025	SM5026	SM5027	SM5028	SM5029	SM5030	SM5031

■Update timing

This device turns ON when the HIOEN/DHIOEN instruction is executed. It turns OFF at the END instruction when the measurement mode is the 1 time measurement mode.

■Clear timing

The timing when the device is cleared is as follows.

- Power OFF→ON
- Reset
- STOP/PAUSE→RUN
- RUN→STOP/PAUSE
- When measurement is stopped by the HIOEN/DHIOEN instruction

Period measurement complete

This flag turns ON at the end of the 1st period measurement. During measurement in the always measurement mode, it stays ON.

■Corresponding devices

The device numbers corresponding to each channel are as follows.

CPU module				High-speed pulse input/output module							
				First module		Second module		Third module		Fourth module	
CH1	CH2	CH3	CH4	CH5	CH6	CH7	CH8	CH9	CH10	CH11	CH12
SM5036	SM5037	SM5038	SM5039	SM5040	SM5041	SM5042	SM5043	SM5044	SM5045	SM5046	SM5047

■Update timing

Devices are updated by the END instruction.

■Clear timing

The timing when the device is cleared is as follows.

- Power OFF→ON
- Reset
- STOP/PAUSE→RUN
- The first END instruction after measurement is started by the HIOEN/DHIOEN instruction

Point

When the HCMOV/DHCMOV instruction is used, the latest value can be read.

Pulse width measurement complete

This flag turns ON at the end of the 1st pulse width measurement. During measurement in the always measurement mode, it stays ON.

■Corresponding devices

The device numbers corresponding to each channel are as follows.

CPU module				High-speed pulse input/output module							
				First module		Second module		Third module		Fourth module	
CH1	CH2	CH3	CH4	CH5	CH6	CH7	CH8	CH9	CH10	CH11	CH12
SM5052	SM5053	SM5054	SM5055	SM5056	SM5057	SM5058	SM5059	SM5060	SM5061	SM5062	SM5063

■Update timing

Devices are updated by the END instruction.

■Clear timing

The timing when the device is cleared is as follows.

- Power OFF→ON
- Reset
- STOP/PAUSE→RUN
- The first END instruction after measurement is started by the HIOEN/DHIOEN instruction



When the HCMOV/DHCMOV instruction is used, the latest value can be read.

Measurement mode

The measurement mode can be checked. The measurement mode can also be changed by turning special relays ON/OFF.

OFF: Always measurement mode

ON: 1 time measurement mode



Measurement mode is applied when measurement is started by the HIOEN/DHIOEN instruction.

If the measurement mode is changed during measurement, operation in the measurement mode after the change begins when the next measurement is started.

■Corresponding devices

The device numbers corresponding to each channel are as follows.

CPU module				High-speed pulse input/output module							
				First module		Second module		Third module		Fourth module	
CH1	CH2	CH3	CH4	CH5	CH6	CH7	CH8	CH9	CH10	CH11	CH12
SM5068	SM5069	SM5070	SM5071	SM5072	SM5073	SM5074	SM5075	SM5076	SM5077	SM5078	SM5079

■Clear timing

The timing when the device is cleared is as follows.

- Power OFF→ON
- Reset
- STOP/PAUSE→RUN

Rising edge ring counter value

The ring counter value when the rising edge is detected is stored.

■Corresponding devices

The device numbers corresponding to each channel are as follows.

CPU module				High-speed pulse input/output module							
				First module		Second module		Third module		Fourth module	
CH1	CH2	CH3	CH4	CH5	CH6	CH7	CH8	CH9	CH10	CH11	CH12
SD5021, SD5020	SD5041, SD5040	SD5061, SD5060	SD5081, SD5080	SD5101, SD5100	SD5121, SD5120	SD5141, SD5140	SD5161, SD5160	SD5181, SD5180	SD5201, SD5200	SD5221, SD5220	SD5241, SD5240

■Update timing

Devices are updated by the END instruction.

■Clear timing

The timing when the device is cleared is as follows.

- Power OFF→ON
- Reset
- STOP/PAUSE→RUN

Falling edge ring counter value

The ring counter value when the falling edge is detected is stored.

■Corresponding devices

The device numbers corresponding to each channel are as follows.

CPU module				High-speed pulse input/output module							
				First module		Second module		Third module		Fourth module	
CH1	CH2	CH3	CH4	CH5	CH6	CH7	CH8	CH9	CH10	CH11	CH12
SD5023, SD5022	SD5043, SD5042	SD5063, SD5062	SD5083, SD5082	SD5103, SD5102	SD5123, SD5122	SD5143, SD5142	SD5163, SD5162	SD5183, SD5182	SD5203, SD5202	SD5223, SD5222	SD5243, SD5242

■Update timing, clear timing

Same as the rising edge ring counter value (☞ Page 314 Rising edge ring counter value)

Pulse width latest value

The latest value of the pulse width is stored.

Point

- When logic switching is set to positive logic, the difference from the rising edge up to the falling edge.
- When logic switching is set to negative logic, the difference from the falling edge up to the rising edge.

■Corresponding devices

The device numbers corresponding to each channel are as follows.

CPU module				High-speed pulse input/output module							
				First module		Second module		Third module		Fourth module	
CH1	CH2	CH3	CH4	CH5	CH6	CH7	CH8	CH9	CH10	CH11	CH12
SD5025, SD5024	SD5045, SD5044	SD5065, SD5064	SD5085, SD5084	SD5105, SD5104	SD5125, SD5124	SD5145, SD5144	SD5165, SD5164	SD5185, SD5184	SD5205, SD5204	SD5225, SD5224	SD5245, SD5244

■Update timing, clear timing

Same as the rising edge ring counter value (☞ Page 314 Rising edge ring counter value)

Pulse width maximum value

The maximum value of the pulse width is stored.

Point

- When logic switching is set to positive logic, the difference from the rising edge up to the falling edge.
- When logic switching is set to negative logic, the difference from the falling edge up to the rising edge.
- The maximum value of the pulse width can be changed only by the HCMOV/DHCMOV instruction.

■Corresponding devices

The device numbers corresponding to each channel are as follows.

CPU module				High-speed pulse input/output module							
				First module		Second module		Third module		Fourth module	
CH1	CH2	CH3	CH4	CH5	CH6	CH7	CH8	CH9	CH10	CH11	CH12
SD5027, SD5026	SD5047, SD5046	SD5067, SD5066	SD5087, SD5086	SD5107, SD5106	SD5127, SD5126	SD5147, SD5146	SD5167, SD5166	SD5187, SD5186	SD5207, SD5206	SD5227, SD5226	SD5247, SD5246

■Update timing

Devices are updated by the END instruction.

When the HCMOV/DHCMOV instruction is executed, devices are updated immediately.

■Clear timing

The timing when the device is cleared is as follows.

- Power OFF→ON
- Reset
- STOP/PAUSE→RUN
- When "0" is written by the HCMOV/DHCMOV instruction

Pulse width minimum value

The minimum value of the pulse width is stored.

Point

- When logic switching is set to positive logic, the difference from the rising edge up to the falling edge.
- When logic switching is set to negative logic, the difference from the falling edge up to the rising edge.
- The minimum value of the pulse width can be changed only by the HCMOV/DHCMOV instruction.

■Corresponding devices

The device numbers corresponding to each channel are as follows.

CPU module				High-speed pulse input/output module							
				First module		Second module		Third module		Fourth module	
CH1	CH2	CH3	CH4	CH5	CH6	CH7	CH8	CH9	CH10	CH11	CH12
SD5029, SD5028	SD5049, SD5048	SD5069, SD5068	SD5089, SD5088	SD5109, SD5108	SD5129, SD5128	SD5149, SD5148	SD5169, SD5168	SD5189, SD5188	SD5209, SD5208	SD5229, SD5228	SD5249, SD5248

■Update timing, clear timing

Same as the pulse width maximum value ( Page 315 Pulse width maximum value)

Period latest value

The latest value of the period is stored.

Point

- When logic switching is set to positive logic, the difference from the previous rising edge up to the latest rising edge.
- When logic switching is set to negative logic, the difference from the previous falling edge up to the latest falling edge.

■Corresponding devices

The device numbers corresponding to each channel are as follows.

CPU module				High-speed pulse input/output module							
				First module		Second module		Third module		Fourth module	
CH1	CH2	CH3	CH4	CH5	CH6	CH7	CH8	CH9	CH10	CH11	CH12
SD5031, SD5030	SD5051, SD5050	SD5071, SD5070	SD5091, SD5090	SD5111, SD5110	SD5131, SD5130	SD5151, SD5150	SD5171, SD5170	SD5191, SD5190	SD5211, SD5210	SD5231, SD5230	SD5251, SD5250

■Update timing, clear timing

Same as the rising edge ring counter value ( Page 314 Rising edge ring counter value)

Period maximum value

The maximum value of the period is stored.

Point

- When logic switching is set to positive logic, the difference from rising edge to rising edge.
- When logic switching is set to negative logic, the difference from falling edge to falling edge.
- The maximum value of the period can be changed only by the HCMOV/DHCMOV instruction.

■Corresponding devices

The device numbers corresponding to each channel are as follows.

CPU module				High-speed pulse input/output module							
				First module		Second module		Third module		Fourth module	
CH1	CH2	CH3	CH4	CH5	CH6	CH7	CH8	CH9	CH10	CH11	CH12
SD5033, SD5032	SD5053, SD5052	SD5073, SD5072	SD5093, SD5092	SD5113, SD5112	SD5133, SD5132	SD5153, SD5152	SD5173, SD5172	SD5193, SD5192	SD5213, SD5212	SD5233, SD5232	SD5253, SD5252

■Update timing, clear timing

Same as the pulse width maximum value ( Page 315 Pulse width maximum value)

Period minimum value

The minimum value of the period is stored.

Point

- When logic switching is set to positive logic, the difference from rising edge to rising edge.
- When logic switching is set to negative logic, the difference from falling edge to falling edge.
- The minimum value of the period can be changed only by the HCMOV/DHCMOV instruction.

■Corresponding devices

The device numbers corresponding to each channel are as follows.

CPU module				High-speed pulse input/output module							
				First module		Second module		Third module		Fourth module	
CH1	CH2	CH3	CH4	CH5	CH6	CH7	CH8	CH9	CH10	CH11	CH12
SD5035, SD5034	SD5055, SD5054	SD5075, SD5074	SD5095, SD5094	SD5115, SD5114	SD5135, SD5134	SD5155, SD5154	SD5175, SD5174	SD5195, SD5194	SD5215, SD5214	SD5235, SD5234	SD5255, SD5254

■Update timing, clear timing

Same as the pulse width maximum value (☞ Page 315 Pulse width maximum value)

Cautions when using the pulse width measurement function

- When the HCMOV/DHCMOV instruction is used, the latest ring counter value, pulse width, cycle, maximum value, and minimum value can be obtained.
- The measurement mode can be changed using the special relays. Note, however, that the measurement mode cannot be changed during pulse width measurement. To change the measurement mode, stop pulse width measurement, change the measurement mode and then resume measurement.
- Pulse measurement is possible only while in RUN status. Pulse width measurement is stopped by RUN→PAUSE and RUN→STOP.
- In a program with interruption priority 1, the HIOEN/DHIOEN instruction cannot be executed to start or stop pulse width measurement of the high-speed pulse input/output module.
- In a program with interruption priority 1, HCMOV/DHCMOV instruction specified with the following devices for the high-speed input/output module cannot be executed.
 - Period measurement complete
 - Pulse width measurement complete
 - Rising edge ring counter value
 - Falling edge ring counter value
 - Pulse width latest value
 - Pulse width maximum value
 - Pulse width minimum value
 - Period latest value
 - Period maximum value
 - Period minimum value
- For functions that share inputs with the pulse width measurement function, refer to ☞ Page 288 Functions that share inputs and outputs.

Examples of program

An example of a program using the pulse width measurement function is explained below.

Outline of operation

A program for measuring the delay time between the rising edges of input signals X1 and X2 on the FX5U CPU module is explained below.

Parameter setting

This program assumes that parameters are set as follows.

Input signals X1 and X2 are assigned to CH1 (X1) and CH2 (X2) by parameters. CH3 and CH4 need not be set.

Item	CH to be used	
	CH1	CH2
Input signal	X1	X2
Input logic switching	Positive logic	Positive logic
Measurement mode	Always measurement mode	Always measurement mode

Program

An operation diagram and program are shown below.

Operation diagram

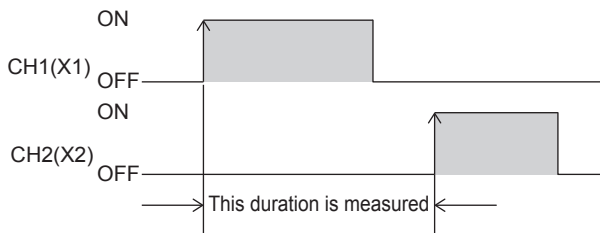

Program

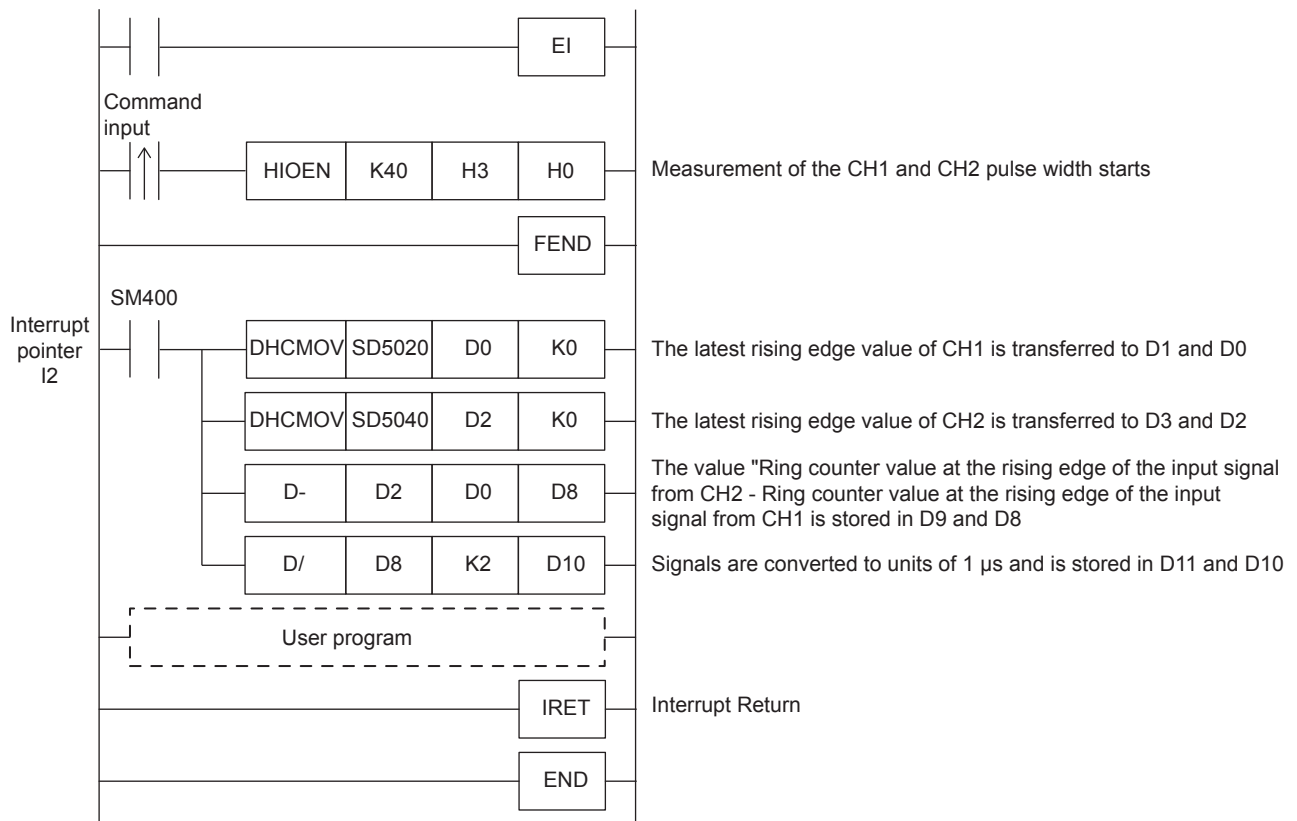

Precautions

If high-speed pulse input/output module operates in an interrupt program with the priority 1, operation error (3580H) occurs. The high-speed pulse input/output module operates in an interrupt program with the priority 2 or 3.

26.4 Pulse Catch Function

This section explains the pulse catch function.

Outline of pulse catch function

The pulse catch function enables pulse signals that are incompletely sampled in regular input processing to be caught. Inputs X0 to X17 on the CPU module and all inputs on the high-speed pulse input/output module can be used on up to 40 channels (CPU module: 8 points, high-speed pulse input/output module 8 points × 4 units).

To use the pulse catch function, pulse catch setting and the input response time must be set with parameters.

An FX3-compatible pulse catch function is mounted on only the CPU module. For details of functions, refer to  Page 325 FX3-Compatible Pulse Catch Function.

Point

The pulse catch function and FX3-compatible pulse catch function can be used simultaneously.

Specifications of pulse catch function

The specifications of the pulse catch function are explained below.

Performance specifications

Pulse catches can be used on inputs X0 to X17 of the CPU module and all inputs on the high-speed pulse input/output module.

■FX5UJ CPU module

- Input response time

Input response times are shown below.

FX5UJ-24M□	FX5UJ-40M□, FX5UJ-60M□	Input response time
X0, X1, X3, X4	X0, X1, X3, X4	10 μs
X2, X5, X6, X7	X2, X5, X6, X7	100 μs
X10 to X15	X10 to X17	200 μs

- Detectable pulse width

Pulse widths that satisfy the following condition can be detected.

Pulse input ON width > input response time

■FX5U/FX5UC CPU module and high-speed pulse input/output module

- Input response time

Input response times are shown below.

FX5U-32M□, FX5UC-32M□	FX5U-64M□, FX5U-80M□, FX5UC-64M□, FX5UC-96M□	High-speed pulse input/output module*1	Input response time
X0 to X5	X0 to X7	X□ to X□+5	5 μs
X6 to X17	X10 to X17	X□+6, X□+7	100 μs

*1 □: Head input number for each high-speed pulse input/output module

- Detectable pulse width

Pulse widths that satisfy the following condition can be detected.

Pulse input ON width > input response time



Pulses cannot be detected normally if the above condition is not satisfied. Set the input response time so that the above condition is satisfied.

Pulse catch function execution procedure

The procedure for executing the pulse catch function is explained below.

1. Check the pulse catch specifications.

Check specifications such as the input response time of the pulse catch. (☞ Page 319 Specifications of pulse catch function)

2. Connect the CPU module to the external device.

For details on wiring to external devices, refer to the following manual

📖 MELSEC iQ-F FX5UJ User's Manual (Hardware)

📖 MELSEC iQ-F FX5U User's Manual (Hardware)

📖 MELSEC iQ-F FX5UC User's Manual (Hardware)

3. Set the parameters.

Set the pulse catch setting and other parameters. (☞ Page 321 Pulse catch parameters)

4. Create the program.

5. Run the program.

Pulse catch parameters

This section explains the pulse catch parameters.

Set the pulse catch parameters in GX Works3.

Outline of parameters

Pulse catch parameters are pulse catch setting and input response time.

Parameter setting

This section explains how to set pulse catch parameters.

For input response time, refer to  Page 329 General-purpose Input Functions.

■CPU module

 Navigation window ⇒ [Parameter] ⇒ [FX5UJCPU] or [FX5UCPU] ⇒ [Module Parameter] ⇒ [High Speed I/O] ⇒ "Input Function" ⇒ "General/Interrupt/Pulse Catch" ⇒ "Detail Setting"

Window

No.	XY Signal	General/Interrupt/Pulse Catch
1	X0	Interrupt (Rising) + Pulse Catch
2	X1	General-purpose Input
3	X2	General-purpose Input
4	X3	General-purpose Input
5	X4	General-purpose Input
6	X5	General-purpose Input
7	X6	General-purpose Input
8	X7	General-purpose Input
9	X10	General-purpose Input
10	X11	General-purpose Input
11	X12	General-purpose Input
12	X13	General-purpose Input
13	X14	General-purpose Input
14	X15	General-purpose Input
15	X16	General-purpose Input
16	X17	General-purpose Input

Displayed items

Item	Description	Setting range	Default
General/Interrupt/Pulse Catch	Set the function to be used. Set to "Interrupt (Rising) + Pulse Catch".	<ul style="list-style-type: none"> • General-purpose Input • Interrupt (Rising) • Interrupt (Falling) • Interrupt (Rising + Falling) • Interrupt (Rising) + Pulse Catch 	General-purpose Input

■High-speed pulse input/output module

Add the high-speed pulse input/output module.

High-speed pulse input/output module is supported only for FX5U/FX5UC CPU module.

Navigation window ⇒ [Parameter] ⇒ [Module Information] ⇒ Right-click ⇒ Add New Module

After adding the high-speed pulse input/output module, make settings on the the screen displayed from the following operation.

Navigation window ⇒ [Parameter] ⇒ [Module Information] ⇒ [1 to 16 (high-speed pulse input/output module)] ⇒ [Module Parameter] ⇒ [High Speed I/O] ⇒ "Input Function" ⇒ "General/Interrupt/Pulse Catch" ⇒ "Detailed Setting"

Window

No.	XY Signal	General/Interrupt/Pulse Catch	Interrupt Pointer
1	X20	Interrupt (Rising) + Pulse Catch	
2	X21	General-purpose Input	
3	X22	General-purpose Input	
4	X23	General-purpose Input	
5	X24	General-purpose Input	
6	X25	General-purpose Input	
7	X26	General-purpose Input	
8	X27	General-purpose Input	

Shown above is the screen at the time when the first high-speed pulse input/output module is selected.

Displayed items

Item	Description	Setting range	Default
General/Interrupt/Pulse Catch	Set the function to be used. Set to "Interrupt (Rising) + Pulse Catch".	<ul style="list-style-type: none"> General-purpose Input Interrupt (Rising) Interrupt (Falling) Interrupt (Rising + Falling) Interrupt (Rising) + Pulse Catch 	General-purpose Input
Interrupt Pointer	Set the interrupt pointer (I) which is assigned to each input. The pulse catch function does not use an interrupt pointer.	I50 to I177	—



Parameters are enabled when the CPU module is powered ON or after a reset.

Operation of pulse catch function

Operation of the pulse catch function is explained below.

Basic operation of pulse catch function

The corresponding input device is turned ON for the duration of the scan following the scan where the pulse signal is detected. The input device is turned OFF at the END instruction.

■ Operation when input signal is used as pulse catch function

The rising edge of the external input signal (X0) is detected, and the input device is turned ON only during the following scan.

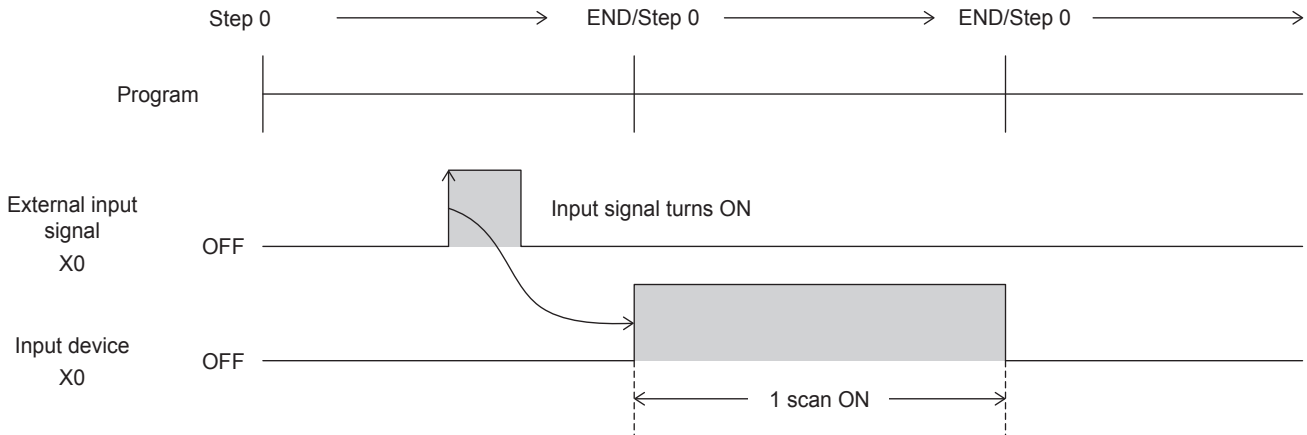

■ Operation when multiple pulses are detected within one scan

The second pulse onwards is ignored. Input pulse signals at intervals of one scan or longer.

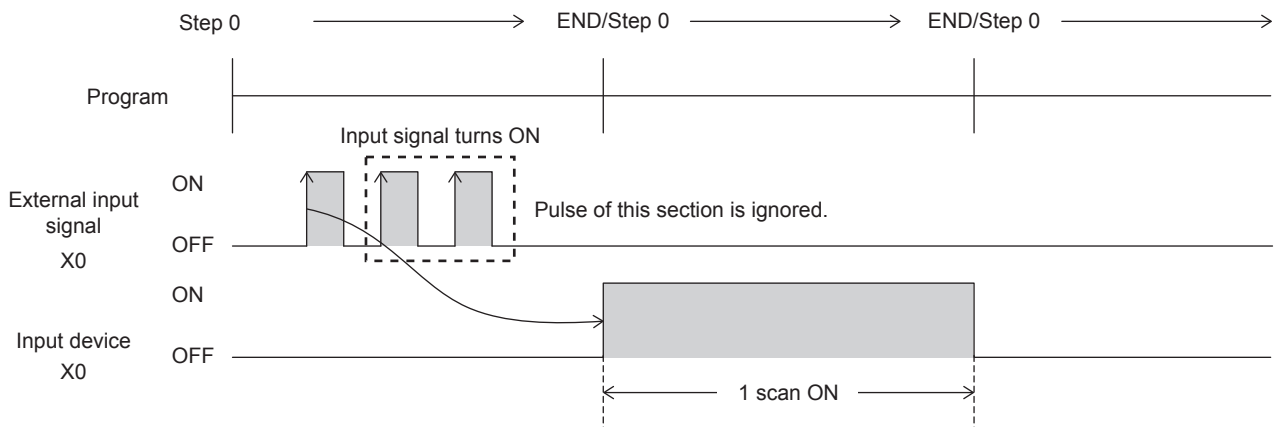

■ Operation when the same pulse is detected for two scans or more

The input device is turned ON for the detected number of scans. Input pulse signals at intervals of one scan or longer.

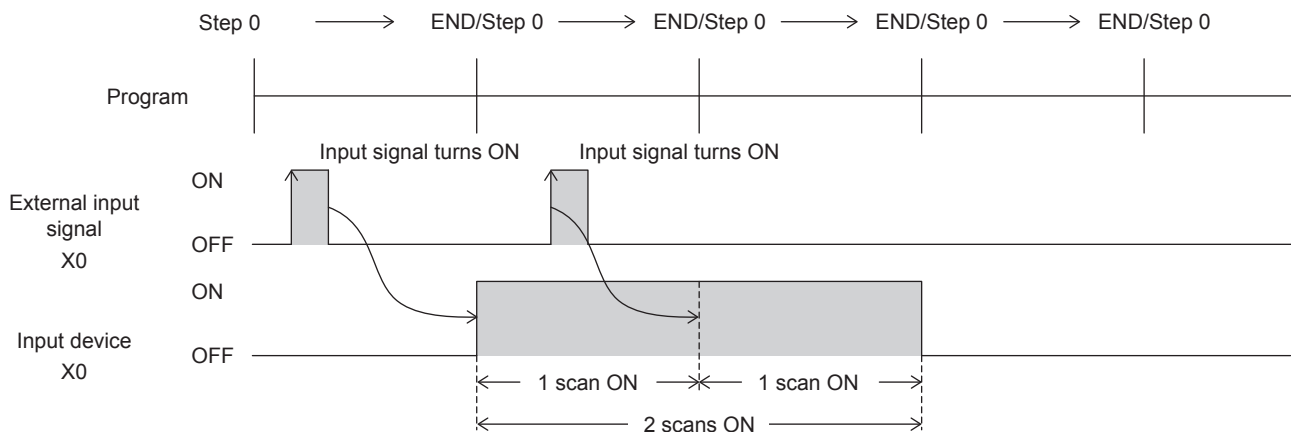

■ Operation when a pulse having an ON width of two scans or more is input

The input device is turned ON for one scan only.

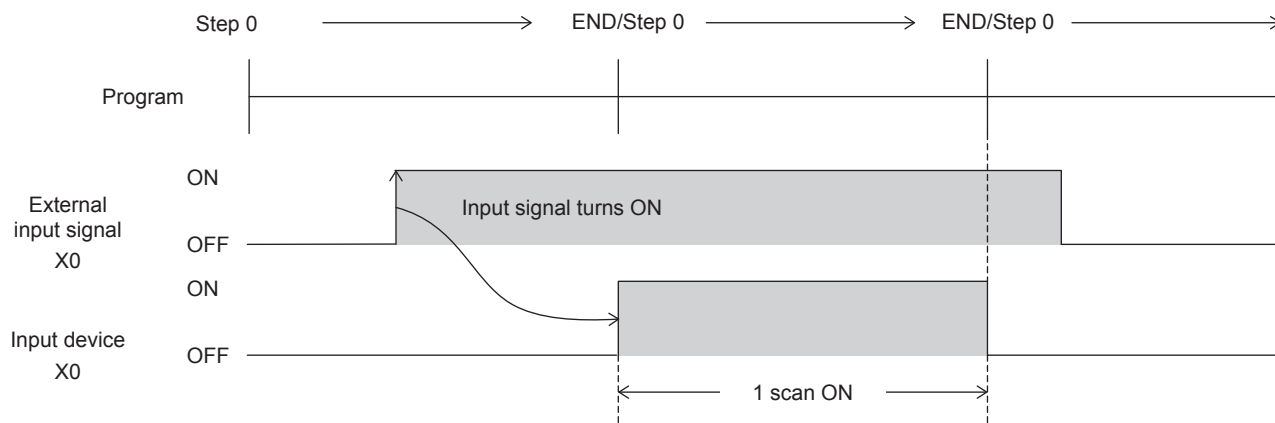

Cautions when using the pulse catch function

- The pulse catch function operates only when “Interrupt (Rising) + Pulse Catch” is set with parameters.
 - The pulse catch function can be used on inputs X0 to X17 on the CPU module. Note, however, that these inputs can be used on up to 8 points.
 - For the functions that share inputs with pulse catch function, refer to  Page 288 Functions that share inputs and outputs.
- Do not perform the following on inputs for which the pulse catch function is selected. Doing so results in the input device not turning ON normally in one scan after the pulse is detected.
- Use of direct device (DX)
 - Execution of input refreshing during execution of the REF, RFS, MTR instructions, etc.

26.5 FX3-Compatible Pulse Catch Function

This section explains the FX3-compatible pulse catch function.

Outline of FX3-compatible pulse catch function

An FX3-compatible pulse catch function is mounted on the CPU module, When the input signal X0 to X7 turns OFF→ON, a special relay (SM8170 to SM8177) is immediately set to ON by interrupt processing. Use of these special relays in a normal sequence program enables pulse signals that are incompletely sampled in regular input processing to be caught. To use the FX3-compatible pulse catch function, pulse catch setting and the input response time must be set with parameters. Functions equivalent to the MELSEC Q/L series pulse catch function are also mounted. For details of functions, refer to  Page 319 Pulse Catch Function.

Point

The pulse catch function and FX3-compatible pulse catch function can be used simultaneously.

Specifications of FX3-compatible pulse catch function

This specifications of the FX3-compatible pulse catch function are explained below.

Performance specifications

FX3-compatible pulse catches can be used on inputs X0 to X7.

■FX5UJ CPU module

- Input response time

Input response times are shown below.

FX5UJ CPU module	Input response time
X0, X1, X3, X4	10 μs
X2, X5, X6, X7	100 μs

- Assignment of input numbers and special relays

The assignments of input numbers and special relays are explained below.

Input number	Corresponding special relay
X0	SM8170
X1	SM8171
X2	SM8172
X3	SM8173
X4	SM8174
X5	SM8175
X6	SM8176
X7	SM8177

■FX5U/FX5UC CPU module

- Input response time

Input response times are shown below.

FX5U-32M□, FX5UC-32M□	FX5U-64M□, FX5U-80M□, FX5UC-64M□, FX5UC-96M□	Input response time
X0 to X5	X0 to X7	5 μs
X6 to X7	—	100 μs

- Assignment of input numbers and special relays

The assignments of input numbers and special relays are explained below.

Input number	Corresponding special relay
X0	SM8170
X1	SM8171
X2	SM8172
X3	SM8173
X4	SM8174
X5	SM8175
X6	SM8176
X7	SM8177

FX3-compatible pulse catch function execution procedure

The procedure for executing the FX3-compatible pulse catch function is explained below.

1. Check the FX3-compatible pulse catch specifications.

Check specifications such as the input response time and corresponding special relay of the FX3-compatible pulse catch.

( Page 325 Specifications of FX3-compatible pulse catch function)

2. Connect the CPU module to the external device.

For details on wiring to external devices, refer to the following manual

 MELSEC iQ-F FX5UJ User's Manual (Hardware)

 MELSEC iQ-F FX5U User's Manual (Hardware)

 MELSEC iQ-F FX5UC User's Manual (Hardware)

3. Set the parameters.

Set the pulse catch setting and other parameters. ( Page 327 FX3-compatible pulse catch parameters)

4. Create the program.

Create the program for using pulse catch.

5. Run the program.

FX3-compatible pulse catch parameters

This section explains the FX3-compatible pulse catch parameters.

Set the FX3-compatible pulse catch parameters in GX Works3.

Outline of parameters

FX3-compatible pulse catch parameters are pulse catch setting and input response time.

For input response time, refer to  Page 329 General-purpose Input Functions.

Parameter setting

This section explains how to set FX3-compatible pulse catch parameters.

■CPU module

 Navigation window ⇒ [Parameter] ⇒ [FX5UJCPU] or [FX5UCPU] ⇒ [Module Parameter] ⇒ [High Speed I/O] ⇒ "Input Function" ⇒ "General/Interrupt/Pulse Catch" ⇒ "Detail Setting"

Window

No.	XY Signal	General/Interrupt/Pulse Catch
1	X0	Interrupt (Rising) + Pulse Catch
2	X1	General-purpose Input
3	X2	General-purpose Input
4	X3	General-purpose Input
5	X4	General-purpose Input
6	X5	General-purpose Input
7	X6	General-purpose Input
8	X7	General-purpose Input

Displayed items

Item	Description	Setting range	Default
General/Interrupt/Pulse Catch Setting	Set the function to be used. Set to "Interrupt (Rising)" or "Interrupt (Rising) + Pulse Catch".	<ul style="list-style-type: none"> • General-purpose Input • Interrupt (Rising) • Interrupt (Falling) • Interrupt (Rising + Falling) • Interrupt (Rising) + Pulse Catch 	General-purpose Input

Point

Parameters are enabled when the CPU module is powered ON or after a reset.

Operation of FX3-compatible pulse catch function

Operation of the FX3-compatible pulse catch function is explained below.

Operation of FX3-compatible pulse catch function

When the status of the input (X0 to X7) changes OFF→ON, a special relay (SM8170 to SM8177) is immediately set to ON by interrupt processing. Pulse catch operates even when an input interrupt is also set in duplicate with other functions. Note, however, that the pulse catch must be set with parameters.

Examples of program

When the status of the X0 changes OFF→ON, SM8170 is immediately set to ON by interrupt processing. To capture input again, turn X2 ON to reset SM8170. (X0 is assumed to be set with parameters.)

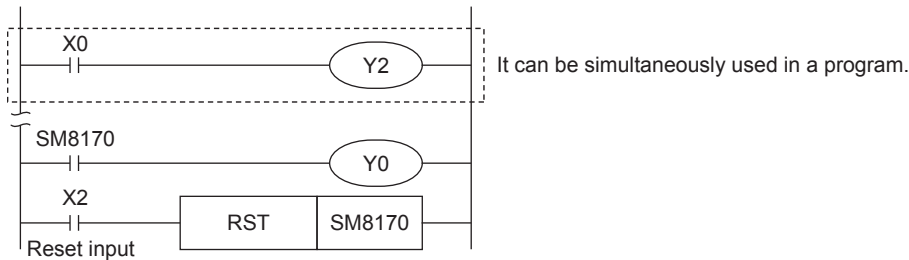

Operation diagram

An operation diagram of the above program example is shown below.

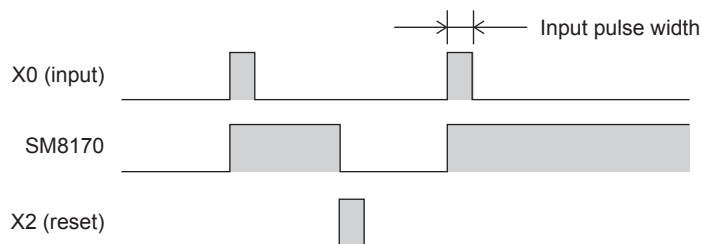

Cautions when using the FX3-compatible pulse catch function

- The FX3-compatible pulse catch function operates only when “Interrupt (Rising)” or “Interrupt (Rising) + Pulse Catch” is set with parameters.
- To capture input again, the special relay that is set must be reset by the program. Accordingly, new input cannot be captured until the special relay that is set is reset.
- The special relays for FX3-compatible pulse catch are cleared at STOP→RUN and a reset.
- The FX3-compatible pulse catch function is executed regardless of the operations of the special relays for disabling interrupts.
- The FX3-compatible pulse catch function is executed regardless of the operations of the EI, DI instruction.
- For the functions that share inputs with FX3-compatible pulse catch function, refer to Page 288 Functions that share inputs and outputs.

26.6 General-purpose Input Functions

The FX5 PLC general-purpose inputs are explained below.

Outline of general-purpose input functions

For general-purpose inputs of the FX5 PLC, the input response time can be set by parameters.

Specifications of general-purpose inputs

Performance specifications

Input response times can be set to general-purpose inputs.

■FX5UJ CPU module

- Input response time setting

Input response times that can be set are shown below. The default value is 10 ms.

Input number set value	Input response time set value
X0 to X377	No Setting, 10 μs, 50 μs, 0.1 ms, 0.2 ms, 0.4 ms, 0.6 ms, 1 ms, 5 ms, 10 ms, 20 ms, 70 ms

Point

- The value obtained by adding on the value of the hardware filter is the actual input response time.
- The input response time of X20 or later for the CPU module is invalid.

- Hardware filter value

The delay times of the hardware filter on the CPU module and high-speed pulse input/output module are shown below.

The hardware filter value of I/O modules is 50 μs when ON, and 150 μs when OFF.

Input number		Hardware filter value	
FX5UJ-24M□	FX5UJ-40M□, FX5UJ-60M□	ON	OFF
X0, X1, X3, X4	X0, X1, X3, X4	5 μs	5 μs
X2, X5, X6, X7	X2, X5, X6, X7	30 μs	50 μs
X10 to X15	X10 to X17	50 μs	150 μs
—	X20 or later	10 ms	10 ms

- Input response time setting units

The following table lists the units (1 point unit/8 point unit) that can be set for the input response time of each CPU module.

CPU module	X0 to X7	X10 to X17
FX5UJ CPU module	1 point unit/8 points units	1 point unit/8 points units

■FX5U/FX5UC CPU module and high-speed pulse input/output module

- Input response time setting

Input response times that can be set are shown below. The default value is 10 ms.

Input number set value	Input response time set value
X0 to X577	No Setting, 10 μs, 50 μs, 0.1 ms, 0.2 ms, 0.4 ms, 0.6 ms, 1 ms, 5 ms, 10 ms, 20 ms, 70 ms



The value obtained by adding on the value of the hardware filter is the actual input response time.

- Hardware filter value

The delay times of the hardware filter on the CPU module and high-speed pulse input/output module are shown below.

The hardware filter value of I/O modules is 50 μs when ON, and 150 μs when OFF.

Input number			Hardware filter value	
FX5U-32M□, FX5UC-32M□	FX5U-64M□, FX5U-80M□, FX5UC-64M□, FX5UC-96M□	High-speed pulse input/output module ^{*1}	ON	OFF
X0 to X5	X0 to X7	X□ to X□+5	2.5 μs	2.5 μs
X6 to X17	X10 to X17	X□+6, X□+7	30 μs	50 μs
—	X20 or later	—	50 μs	150 μs

*1 □: Head input number for each high-speed pulse input/output module

- Input response time setting units

The following table lists the units (1 point unit/8 point unit) that can be set for the input response time of each CPU module.

All the points of the high-speed pulse input/output module are in the unit of one point or 8 points.

CPU module	X0 to X7	X10 to X17	X20 to X27	X30 to X37	X40 to X47	X50 to X57
FX5U-32M□	1 point unit/8 points units	1 point unit/8 points units	—	—	—	—
FX5U-64M□, FX5UC-64M□	1 point unit/8 points units	1 point unit/8 points units	1 point unit/8 points units	1 point unit/8 points units	—	—
FX5U-80M□	1 point unit/8 points units	1 point unit/8 points units	1 point unit/8 points units	1 point unit/8 points units	8 points units ^{*2}	—
FX5UC-96M□	1 point unit /8 point units	1 point unit /8 point units	1 point unit /8 point units	1 point unit /8 point units	8 point units ^{*2}	8 point units ^{*3}

*2 When 1 point unit is set for the input response time using GX Works3, X41 to X47 operate with the input response time set to X40.

*3 When 1 point unit is set for the input response time using GX Works3, X51 to X57 operate with the input response time set to X50.

General-purpose input function parameters

This section explains the general-purpose input parameters.

Set the input response time parameters in GX Works3.

Parameter setting

This section explains how to set the input response time parameters.

Set the input response time.

 Navigation window ⇒ [Parameter] ⇒ [FX5UJCPU] or [FX5UCPU] ⇒ [Module Parameter] ⇒ [Input Response Time]

Window

Item	Setting
X0-X7	Specify the input response time of X0 to X7.
Response Type	High-Speed
X0	10ms
X1	10ms
X2	10ms
X3	10ms
X4	10ms
X5	10ms
X6	10ms
X7	10ms
X10-X17	Specify the input response time of X10 to X17.
Response Type	Normal
X10	10ms
X11	10ms
X12	10ms
X13	10ms
X14	10ms
X15	10ms
X16	10ms
X17	10ms

Displayed items

Item	Description	Setting range	Default
Response Type	Select the input response time between 1 point unit and 8 point unit. High-Speed: Unit of 1 point Normal: Unit of 8 points	<ul style="list-style-type: none"> High-Speed Normal 	—
<ul style="list-style-type: none"> ■FX5UJ CPU module <ul style="list-style-type: none"> • X0 to X377 ■FX5U/FX5UC CPU module <ul style="list-style-type: none"> • X0 to X577 	Set the input response time.	<ul style="list-style-type: none"> No Setting 10micro-s (μs) 50micro-s (μs) 0.1ms 0.2ms 0.4ms 0.6ms 1ms 5ms 10ms 20ms 70ms 	10ms



Parameters are enabled when the CPU module is powered ON or after a reset.

26.7 PWM Function

This chapter explains the PWM function.

Outline of PWM output

The CPU module and the high-speed pulse input/output module allow PWM output on up to 12 channels.

For PWM output, the output channel assignment, pulse/cycle units, output pulse logic, pulse width, cycle, etc. are set using parameters, and the HIOEN/DHIOEN instruction is used to start/stop pulse output.

Also, the regular PWM/DPWM instruction can be used.

High-speed pulse input/output module is supported only for FX5U/FX5UC CPU module.

PWM output specifications

The PWM output specifications are explained below.

Number of output channels

■FX5UJ CPU module

Up to 4 channels can be used for PWM output.

The output device assignment is as follows.

CPU module			
CH1	CH2	CH3	CH4
Y0 to Y7 (Any device can be set.)			

■FX5U/FX5UC CPU module and high-speed pulse input/output module

Up to 12 channels (CPU module 4CH + high-speed pulse input/output module 2CH × 4 units) can be used for PWM output.

The output device assignment is as follows.

CPU module				High-speed pulse input/output module*1							
				First module		Second module		Third module		Fourth module	
CH1	CH2	CH3	CH4	CH5	CH6	CH7	CH8	CH9	CH10	CH11	CH12
Y0 to Y7 (Any device can be set.)				Y□+1	Y□+5	Y□+1	Y□+5	Y□+1	Y□+5	Y□+1	Y□+5

*1 □: Head output number for each high-speed pulse input/output module



Outputs (Y) assigned for PWM output in parameter settings cannot be used by the positioning function.

Setting range of period and pulse width

The setting values that can be set for cycle and pulse width are shown below.

■FX5UJ CPU module

Output number	Period		Pulse width	
	1 ms units	1 μ s units	1 ms units	1 μ s units
Y0 to Y2	1 to 2147483 ms	5 to 2147483647 μ s	1 to 2147483 ms	2 to 2147483647 μ s
Y3 to Y7	1 to 2147483 ms	400 to 2147483647 μ s	1 to 2147483 ms	200 to 2147483647 μ s

■FX5U/FX5UC CPU module and high-speed pulse input/output module

Output number		Period		Pulse width	
FX5U/FX5UC CPU module	High-speed pulse input/output module*1	1 ms units	1 μ s units	1 ms units	1 μ s units
Y0 to Y3	Y□+1, Y□+5	1 to 2147483 ms	5 to 2147483647 μ s	1 to 2147483 ms	2 to 2147483647 μ s
Y4 to Y7	—	1 to 2147483 ms	400 to 2147483647 μ s	1 to 2147483 ms	200 to 2147483647 μ s

*1 □: Head output number for each high-speed pulse input/output module

The response time for actual output varies depending on the connected load. Check the output specifications of the module that uses PWM outputs. For the output specifications, refer to the manual of each module.

Relationship between cycle and pulse width

The relationship between period and pulse width is shown below.

■When positive logic is set

The relationship between the period and pulse width when the output pulse logic at start of pulse output is set to "positive logic" is shown below. (The pulse width is called the "ON width".)

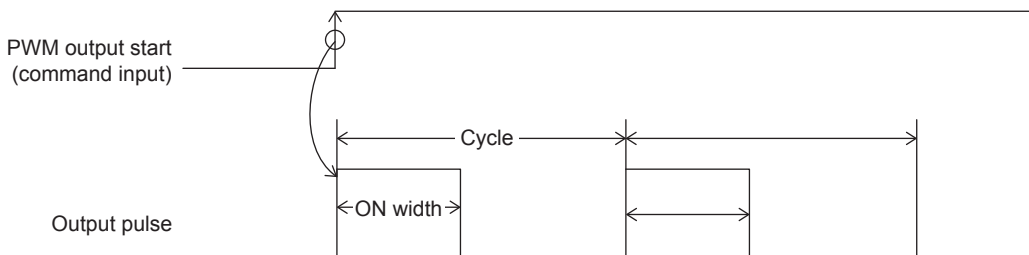

Point

- When positive logic is set, PWM output begins from output ON.)
- Pulse output is stopped at the specified number of pulses.
- Pulse output stops in the output (Y) status of before PWM output was started.

■When negative logic is set

The relationship between the period and pulse width when the output pulse logic at start of pulse output is set to "negative logic" is shown below. (The pulse width is called the "OFF width".)

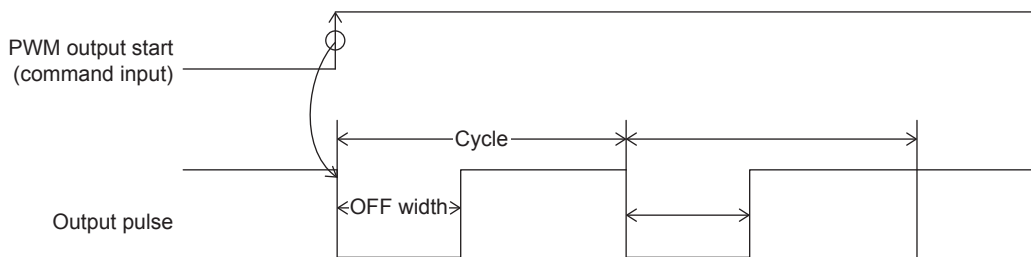

Point

- When negative logic is set, PWM output begins when the output pulse turns OFF.
- Pulse output is stopped at the specified number of pulses.
- Pulse output stops in the output (Y) status of before PWM output was started.

PWM driving method

PWM output is driven by either of the following methods.

■Driven by HIOEN/DHIOEN instruction

The logical settings like output destination, cycle, pulse width, output pulse logic, etc. are set in parameters, and the HIOEN/DHIOEN instruction is used to execute pulse output. For parameters, refer to Page 335 PWM output parameters.

For the HIOEN/DHIOEN instruction, refer to MELSEC iQ-F FX5 Programming Manual (Instructions, Standard Functions/Function Blocks).

■Driven by PWM/DPWM instruction

The PWM/DPWM instruction is used to execute pulse output.

For the PWM/DPWM instruction, refer to MELSEC iQ-F FX5 Programming Manual (Instructions, Standard Functions/Function Blocks).

PWM output function execution procedure

The procedure for executing the PWM output function is explained below.

1. Check the specifications of PWM output.

Check specifications such as pulse output performance of PWM output. (☞ Page 332 PWM output specifications)

2. Connect the CPU module to the external device.

For details on wiring to external devices, refer to the following manual

📖 MELSEC iQ-F FX5UJ User's Manual (Hardware)

📖 MELSEC iQ-F FX5U User's Manual (Hardware)

📖 MELSEC iQ-F FX5UC User's Manual (Hardware)

3. Set the parameters.

Set the output destination, cycle, pulse width, output pulse logic, etc. of the PWM in parameters, (☞ Page 335 PWM output parameters)

4. Create the program.

Create the program for using PWM output.

5. Run the program.

PWM output parameters

This section explains the PWM output parameters.

Set the PWM output parameters in GX Works3.

Outline of parameters

PWM output parameters are output destination, pulse width/cycle unit, output pulse logic, pulse width, and period.

Parameter setting

This section explains how to set the PWM output parameters.

Set the output destination, pulse width/cycle unit, output pulse logic, pulse width, period, etc. of the channel to be used.

■CPU module

☞ Navigation window ⇒ [Parameter] ⇒ [FX5UJCPU] or [FX5UCPU] ⇒ [Module Parameter] ⇒ [High Speed I/O] ⇒ "Output Function" ⇒ "PWM" ⇒ "Detail Setting"

Window

Item	CH1	CH2	CH3	CH4
Use PWM Output	Set whether to use PWM output or not.			
Use/Not Use	Enable	Enable	Disable	Enable
Output Signal	Set the output destination device.			
Output Signal	Y0	Y1	Y0	Y3
Pulse Width/Cycle Unit	Set pulse width/cycle unit.			
Pulse Width/Cycle Unit	1ms	1micro-s	1ms	1ms
Output Pulse Logic	Set output pulse logic.			
Output Pulse Logic	Positive Logic	Positive Logic	Positive Logic	Negative Logic
Pulse Width	Set pulse width.			
Pulse Width	10 ms	100 micro-s	1 ms	200 ms
Cycle	Set cycle.			
Cycle	20 ms	500 micro-s	1 ms	300 ms

Displayed items

Item	Description	Setting range	Default
Use PWM Output	Set whether to use PWM output or not.	<ul style="list-style-type: none"> • Disable • Enable 	Disable
Output Signal	Set the output destination device of output signal.	Y0 to Y7	—
Pulse Width/Cycle Unit	Set pulse width/cycle unit.	<ul style="list-style-type: none"> • 1ms • 1micro-s (μs) 	—
Output Pulse Logic	Sets output pulse logic.	<ul style="list-style-type: none"> • Positive Logic • Negative Logic 	—
Pulse Width	Sets the ON/OFF width of the pulse.	<p>■FX5UJ CPU module</p> <ul style="list-style-type: none"> • When pulse width/period unit is set to 1 ms Y0 to Y2 : 1 to 2147483 ms Y3 to Y7 : 1 to 2147483 ms • When pulse width/period unit is set to 1 micro-s (μs) Y0 to Y2 : 2 to 2147483647 micro-s (μs) Y3 to Y7 : 200 to 2147483647 micro-s (μs) <p>■FX5U/FX5UC CPU module</p> <ul style="list-style-type: none"> • When pulse width/period unit is set to 1 ms Y0 to Y3 : 1 to 2147483 ms Y4 to Y7 : 1 to 2147483 ms • When pulse width/period unit is set to 1 micro-s (μs) Y0 to Y3 : 2 to 2147483647 micro-s (μs) Y4 to Y7 : 200 to 2147483647 micro-s (μs) 	—
Cycle	Sets cycle.	<p>■FX5UJ CPU module</p> <ul style="list-style-type: none"> • When pulse width/period unit is set to 1 ms Y0 to Y2 : 1 to 2147483 ms Y3 to Y7 : 1 to 2147483 ms • When pulse width/period unit is set to 1 micro-s (μs) Y0 to Y2 : 5 to 2147483647 micro-s (μs) Y3 to Y7 : 400 to 2147483647 micro-s (μs) <p>■FX5U/FX5UC CPU module</p> <ul style="list-style-type: none"> • When pulse width/cycle unit is set to 1 ms Y0 to Y3 : 1 to 2147483 ms Y4 to Y7 : 1 to 2147483 ms • When pulse width/cycle unit is set to 1 micro-s (μs) Y0 to Y3 : 5 to 2147483647 micro-s (μs) Y4 to Y7 : 400 to 2147483647 micro-s (μs) 	—

■High-speed pulse input/output module

Add the high-speed pulse input/output module.

Navigation window ⇒ [Parameter] ⇒ [Module Information] ⇒ Right-click ⇒ Add New Module

After adding the high-speed pulse input/output module, make settings on the the screen displayed from the following operation.

Navigation window ⇒ [Parameter] ⇒ [Module Information] ⇒ [1 to 16 (high-speed pulse input/output module)] ⇒ [Module Parameter] ⇒ "Output Function" ⇒ "PWM" ⇒ "Detail Setting"

Window

Item	CH5	CH6
Use PWM Output	Set whether to use PWM output or not .	
Use/Not Use	Enable	Enable
Output Signal	Set the output destination device.	
Output Signal	Y21	Y25
Pulse Width/Cycle Unit	Set pulse width/cycle unit.	
Pulse Width/Cycle Unit	1ms	1micro-s
Output Pulse Logic	Set output pulse logic.	
Output Pulse Logic	Positive Logic	Negative Logic
Pulse Width	Set pulse width.	
Pulse Width	100 ms	300 micro-s
Cycle	Set cycle.	
Cycle	500 ms	1000 micro-s

Shown above is the screen at the time when the first high-speed pulse input/output module is selected.

Displayed items

Item	Description	Setting range	Default
Use PWM Output	Set whether to use PWM output or not.	<ul style="list-style-type: none"> • Disable • Enable 	Disable
Output Signal	The output destination device of output signal.The output number is fixed for each channel.	<ul style="list-style-type: none"> • CH□: Y■+1*1 • CH□+1: Y■+5*1 	—
Pulse Width/Cycle Unit	Set pulse width/cycle unit.	<ul style="list-style-type: none"> • 1ms • 1micro-s (μs) 	—
Output Pulse Logic	Sets output pulse logic.	<ul style="list-style-type: none"> • Positive Logic • Negative Logic 	—
Pulse Width	Sets the ON/OFF width of the pulse.	<ul style="list-style-type: none"> • When pulse width/period unit is set to 1 ms 1 to 2147483 ms • When pulse width/period unit is set to 1 micro-s (μs) 1 to 2147483647 micro-s (μs) 	—
Cycle	Sets cycle.	<ul style="list-style-type: none"> • When pulse width/cycle unit is set to 1 ms 1 to 2147483 ms • When pulse width/cycle unit is set to 1 micro-s (μs) 1 to 2147483647 micro-s (μs) 	—

*1 The number in □ is first module: 5, second module: 7, third module: 9, fourth module: 11.
The number in ■ is the head output number for each high-speed pulse input/output module.

Point

The items specified in the parameters are stored in special devices when the CPU module is set from STOP to RUN.

List of Special relays/special registers

The list of special relays/special registers used in PWM output is shown below.

○: Supported, ×: Not supported

R: Read only, R/W: Read or Write

Special relays/ special registers	Function	Description	Default	Function support		R/W
				FX5UJ	FX5U/ FX5UC	
SM5300	Operation monitor (CH1)	The operation/stopped status of PWM output on the target channel can be checked. OFF: Stopped ON: In operation	OFF	○	○	R
SM5301	Operation monitor (CH2)			○	○	
SM5302	Operation monitor (CH3)			○	○	
SM5303	Operation monitor (CH4)			○	○	
SM5304	Operation monitor (CH5)			×	○	
SM5305	Operation monitor (CH6)			×	○	
SM5306	Operation monitor (CH7)			×	○	
SM5307	Operation monitor (CH8)			×	○	
SM5308	Operation monitor (CH9)			×	○	
SM5309	Operation monitor (CH10)			×	○	
SM5310	Operation monitor (CH11)			×	○	
SM5311	Operation monitor (CH12)			×	○	
SM5316	PWM output complete flag (CH1)	The end status of PWM output on the target channel can be checked. OFF: Other than normally end ON: Normally end	OFF	○	○	R/W
SM5317	PWM output complete flag (CH2)			○	○	
SM5318	PWM output complete flag (CH3)			○	○	
SM5319	PWM output complete flag (CH4)			○	○	
SM5320	PWM output complete flag (CH5)			×	○	
SM5321	PWM output complete flag (CH6)			×	○	
SM5322	PWM output complete flag (CH7)			×	○	
SM5323	PWM output complete flag (CH8)			×	○	
SM5324	PWM output complete flag (CH9)			×	○	
SM5325	PWM output complete flag (CH10)			×	○	
SM5326	PWM output complete flag (CH11)			×	○	
SM5327	PWM output complete flag (CH12)			×	○	
SM5332	PWM output abnormal end flag (CH1)	The end status of PWM output on the target channel can be checked. OFF: No error ON: Abnormal end	OFF	○	○	R/W
SM5333	PWM output abnormal end flag (CH2)			○	○	
SM5334	PWM output abnormal end flag (CH3)			○	○	
SM5335	PWM output abnormal end flag (CH4)			○	○	
SM5336	PWM output abnormal end flag (CH5)			×	○	
SM5337	PWM output abnormal end flag (CH6)			×	○	
SM5338	PWM output abnormal end flag (CH7)			×	○	
SM5339	PWM output abnormal end flag (CH8)			×	○	
SM5340	PWM output abnormal end flag (CH9)			×	○	
SM5341	PWM output abnormal end flag (CH10)			×	○	
SM5342	PWM output abnormal end flag (CH11)			×	○	
SM5343	PWM output abnormal end flag (CH12)			×	○	
SD5301, SD5300	CH1 number of output pulses	The number of pulses to output are stored.	0	○	○	R/W

Special relays/ special registers	Function	Description	Default	Function support		R/W
				FX5UJ	FX5U/ FX5UC	
SD5303, SD5302	CH1 pulse width	The pulse width is stored.	0	○	○	R/W
SD5305, SD5304	CH1 period	The period is stored.	0	○	○	R/W
SD5307, SD5306	CH1 Number of output pulses current value monitor	The current value of the number of output pulses is stored.	0	○	○	R
SD5317, SD5316	CH2 number of output pulses	The number of pulses to output are stored.	0	○	○	R/W
SD5319, SD5318	CH2 pulse width	The pulse width is stored.	0	○	○	R/W
SD5321, SD5320	CH2 period	The period is stored.	0	○	○	R/W
SD5323, SD5322	CH2 Number of output pulses current value monitor	The current value of the number of output pulses is stored.	0	○	○	R
SD5333, SD5332	CH3 number of output pulses	The number of pulses to output are stored.	0	○	○	R/W
SD5335, SD5334	CH3 pulse width	The pulse width is stored.	0	○	○	R/W
SD5337, SD5336	Ch3 period	The period is stored.	0	○	○	R/W
SD5339, SD5338	CH3 Number of output pulses current value monitor	The current value of the number of output pulses is stored.	0	○	○	R
SD5349, SD5348	CH4 number of output pulses	The number of pulses to output are stored.	0	○	○	R/W
SD5351, SD5350	CH4 pulse width	The pulse width is stored.	0	○	○	R/W
SD5353, SD5352	CH4 period	The period is stored.	0	○	○	R/W
SD5355, SD5354	CH4 Number of output pulses current value monitor	The current value of the number of output pulses is stored.	0	○	○	R
SD5365, SD5364	CH5 number of output pulses	The number of pulses to output are stored.	0	×	○	R/W
SD5367, SD5366	CH5 pulse width	The pulse width is stored.	0	×	○	R/W
SD5369, SD5368	CH5 period	The period is stored.	0	×	○	R/W
SD5381, SD5380	CH6 number of output pulses	The number of pulses to output are stored.	0	×	○	R/W
SD5383, SD5382	CH6 pulse width	The pulse width is stored.	0	×	○	R/W
SD5385, SD5384	CH6 period	The period is stored.	0	×	○	R/W
SD5397, SD5396	CH7 number of output pulses	The number of pulses to output are stored.	0	×	○	R/W
SD5399, SD5398	CH7 pulse width	The pulse width is stored.	0	×	○	R/W
SD5401, SD5400	CH7 period	The period is stored.	0	×	○	R/W
SD5413, SD5412	CH8 number of output pulses	The number of pulses to output are stored.	0	×	○	R/W
SD5415, SD5414	CH8 pulse width	The pulse width is stored.	0	×	○	R/W
SD5417, SD5416	CH8 period	The period is stored.	0	×	○	R/W
SD5429, SD5428	CH9 number of output pulses	The number of pulses to output are stored.	0	×	○	R/W
SD5431, SD5430	CH9 pulse width	The pulse width is stored.	0	×	○	R/W
SD5433, SD5432	CH9 period	The period is stored.	0	×	○	R/W
SD5445, SD5444	CH10 number of output pulses	The number of pulses to output are stored.	0	×	○	R/W
SD5447, SD5446	CH10 pulse width	The pulse width is stored.	0	×	○	R/W
SD5449, SD5448	CH10 period	The period is stored.	0	×	○	R/W
SD5461, SD5460	CH11 number of output pulses	The number of pulses to output are stored.	0	×	○	R/W
SD5463, SD5462	CH11 pulse width	The pulse width is stored.	0	×	○	R/W
SD5465, SD5464	CH11 period	The period is stored.	0	×	○	R/W
SD5477, SD5476	CH12 number of output pulses	The number of pulses to output are stored.	0	×	○	R/W
SD5479, SD5478	CH12 pulse width	The pulse width is stored.	0	×	○	R/W
SD5481, SD5480	CH12 period	The period is stored.	0	×	○	R/W

Details of special relays/special registers

Details of special relays/special registers used in PWM output are explained below.

Operation monitor

This device is for monitoring the operation/stopped status of PWM output.

■Corresponding devices

The device numbers corresponding to each channel are as follows.

CPU module				High-speed pulse input/output module							
				First module		Second module		Third module		Fourth module	
CH1	CH2	CH3	CH4	CH5	CH6	CH7	CH8	CH9	CH10	CH11	CH12
SM5300	SM5301	SM5302	SM5303	SM5304	SM5305	SM5306	SM5307	SM5308	SM5309	SM5310	SM5311

■Update timing

The timing of device update is as follows.

ON	OFF
<ul style="list-style-type: none"> • PWM output driven by HIOEN/DHIOEN instruction • PWM/DPWM instruction ON execution 	<ul style="list-style-type: none"> • PWM output stopped by HIOEN/DHIOEN instruction • After end of output of the specified number of pulses • PWM/DPWM instruction OFF execution • Activation contact turned OFF • Power OFF→ON, reset, RUN→STOP/PAUSE

PWM output complete flag

This device is for monitoring the completion status (normal completion) of PWM output.

■Corresponding devices

The device numbers corresponding to each channel are as follows.

CPU module				High-speed pulse input/output module							
				First module		Second module		Third module		Fourth module	
CH1	CH2	CH3	CH4	CH5	CH6	CH7	CH8	CH9	CH10	CH11	CH12
SM5316	SM5317	SM5318	SM5319	SM5320	SM5321	SM5322	SM5323	SM5324	SM5325	SM5326	SM5327

■Update timing

The timing of device update is as follows.

ON	OFF
<ul style="list-style-type: none"> • At execution of the PWM/DPWM, HIOEN/DHIOEN instruction or the END processing after the output of the specified pulse count is output 	<ul style="list-style-type: none"> • Power OFF→ON, reset, STOP/PAUSE→RUN • When pulse output starts • When turned OFF by the user



If the number of output pulses is set to "0" (unlimited output), PWM output complete flag is not turned ON.

PWM output abnormal end flag

This device is for monitoring the end status (abnormal end) of PWM output.

■Corresponding devices

The device numbers corresponding to each channel are as follows.

CPU module				High-speed pulse input/output module							
				First module		Second module		Third module		Fourth module	
CH1	CH2	CH3	CH4	CH5	CH6	CH7	CH8	CH9	CH10	CH11	CH12
SM5332	SM5333	SM5334	SM5335	SM5336	SM5337	SM5338	SM5339	SM5340	SM5341	SM5342	SM5343

■Update timing

The timing of device update is as follows.

ON	OFF
<ul style="list-style-type: none"> At stop of pulse output due to an error in the setting value of the pulse width, period, or output pulse count At stop of pulse output due to the relation of pulse width > period In the case of forced stop with SM8034 (all output disable) or output cannot be started 	<ul style="list-style-type: none"> Power OFF→ON, reset, STOP/PAUSE→RUN When pulse output starts When turned OFF by the user After forced stop by SM8034 (all output disable), SM8034 is turned off, and PWM output resumes (only when unlimited output)

Point

The ON timing of the PWM output abnormal end flag includes startup of the PWM/DPWM, HIOEN/ DHIEN instruction.

Number of output pulses

The number of output pulses of PWM output is stored.

When "0" is set, output is continued without any limitation.

■Corresponding devices

The device numbers corresponding to each channel are as follows.

CPU module				High-speed pulse input/output module							
				First module		Second module		Third module		Fourth module	
CH1	CH2	CH3	CH4	CH5	CH6	CH7	CH8	CH9	CH10	CH11	CH12
SD5301, SD5300	SD5317, SD5316	SD5333, SD5332	SD5349, SD5348	SD5365, SD5364	SD5381, SD5380	SD5397, SD5396	SD5413, SD5412	SD5429, SD5428	SD5445, SD5444	SD5461, SD5460	SD5477, SD5476

■Update timing

The timing to reflect the device in operation is as follows.

- When the HCMOV/DHCMOV instruction is executed (values updated immediately)
- When the PWM/DPWM instruction is executed
- END processing

■Clear timing

The timing when the device is cleared is as follows.

- STOP/PAUSE→RUN

Point

- If the number of output pulses written is equal to or smaller than the number of pulses that have already been output, pulse output is stopped after the pulses being currently output are completed.
- If the number of output pulses written is greater than the number of pulses that have already been output, pulse output is stopped after the specified number of pulses are output.
- If the number of output pulses is set to "0" (output without any limitation), the value cannot be changed while pulses are being output.
- The number of output pulses cannot be changed to "0" (output without any limitation) while pulses are being output.

Pulse width

The pulse width of PWM output is stored.

■Corresponding devices

The device numbers corresponding to each channel are as follows.

CPU module				High-speed pulse input/output module							
				First module		Second module		Third module		Fourth module	
CH1	CH2	CH3	CH4	CH5	CH6	CH7	CH8	CH9	CH10	CH11	CH12
SD5303, SD5302	SD5319, SD5318	SD5335, SD5334	SD5351, SD5350	SD5367, SD5366	SD5383, SD5382	SD5399, SD5398	SD5415, SD5414	SD5431, SD5430	SD5447, SD5446	SD5463, SD5462	SD5479, SD5478

■Update timing

The timing to reflect the device in operation is as follows.

- When the HCMOV/DHCMOV instruction is executed (values updated immediately)
- When the PWM/DPWM instruction is executed
- END processing

■Clear timing

The timing when the device is cleared is as follows.

- STOP/PAUSE→RUN

Point

- The pulse width and cycle can be changed even while pulses are being output.
- The pulse width and cycle are stored in the unit specified by the parameter (ms or μ s).

Period

The period of PWM output is stored.

■Corresponding devices

The device numbers corresponding to each channel are as follows.

CPU module				High-speed pulse input/output module							
				First module		Second module		Third module		Fourth module	
CH1	CH2	CH3	CH4	CH5	CH6	CH7	CH8	CH9	CH10	CH11	CH12
SD5305, SD5304	SD5321, SD5320	SD5337, SD5336	SD5353, SD5352	SD5369, SD5368	SD5385, SD5384	SD5401, SD5400	SD5417, SD5416	SD5433, SD5432	SD5449, SD5448	SD5465, SD5464	SD5481, SD5480

■Update timing

The timing to reflect the device in operation is as follows.

- When the HCMOV/DHCMOV instruction is executed (values updated immediately)
- When the PWM/DPWM instruction is executed
- END processing

■Clear timing

The timing when the device is cleared is as follows.

- STOP/PAUSE→RUN

Point

- The pulse width and cycle can be changed even while pulses are being output.
- The pulse width and cycle are stored in the unit specified by the parameter (ms or μ s).

Number of output pulses current value monitor

The current value of the number of output pulses of PWM output is stored.

■Corresponding devices

The device numbers corresponding to each channel are as follows.

CH1	CH2	CH3	CH4
SD5307, SD5306	SD5323, SD5322	SD5339, SD5338	SD5355, SD5354

■Update timing

The timing to reflect the device in operation is as follows.

- When the HCMOV/DHCMOV instruction is executed (values updated immediately)
- When the PWM/DPWM instruction is executed
- END processing

■Clear timing

The timing when the device is cleared is as follows.

- Power OFF→ON
- Reset
- STOP/PAUSE→RUN

Point

- If the number of output pulses is set to "0" (output without any limitation), the number of output pulse current value monitor is fixed at "0".
- The number of output pulse current value monitor can be changed even while pulses are being output.

Cautions when using the PWM function

- Set the pulse width to a value 2 μ s more and period to a value 5 μ s more.
- Set the value so that pulse width \leq period.
- The PWM/DPWM instruction is not executed when a channel number not selected for PWM output in parameters setting is specified by the PWM/DPWM instruction.
- If the all output disable flag (SM8034) is turned ON while PWM is output, PWM output is stopped. However, when the number of output pulses is "0" (unlimited output), the operation restarts when SM8034 is turned OFF.
- In a program with interruption priority 1, the HCMOV/DHCMOV instruction specified with the following devices cannot be executed.
 - Number of output pulses
 - Pulse width
 - Period
- For functions that share outputs with the PWM function, refer to  Page 288 Functions that share inputs and outputs.

Examples of program

An example of a program using the PWM function is explained below.

Outline of operation

An example of a program using output Y0 on the FX5U CPU module to output one pulse with a delay is explained below.

Parameter setting

This program assumes that parameters are set as follows.

CH2, CH3 and CH4 need not be set.

Item	CH to be used
	CH1
Output destination	Y0
Output pulse logic	Negative logic (Output from OFF)
Pulse width	50 ms
Cycle	60 ms

Program

An operation diagram and program are shown below.

■ Operation diagram

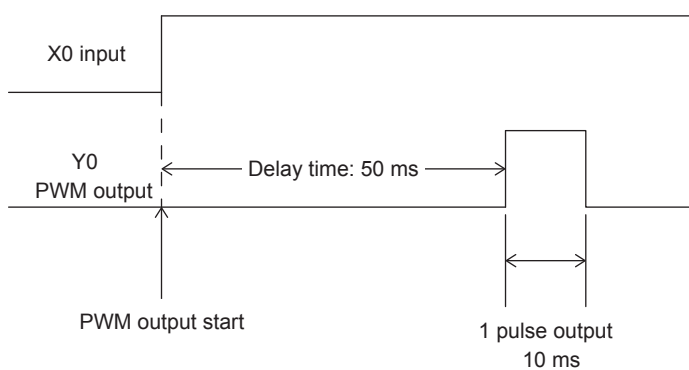

Program

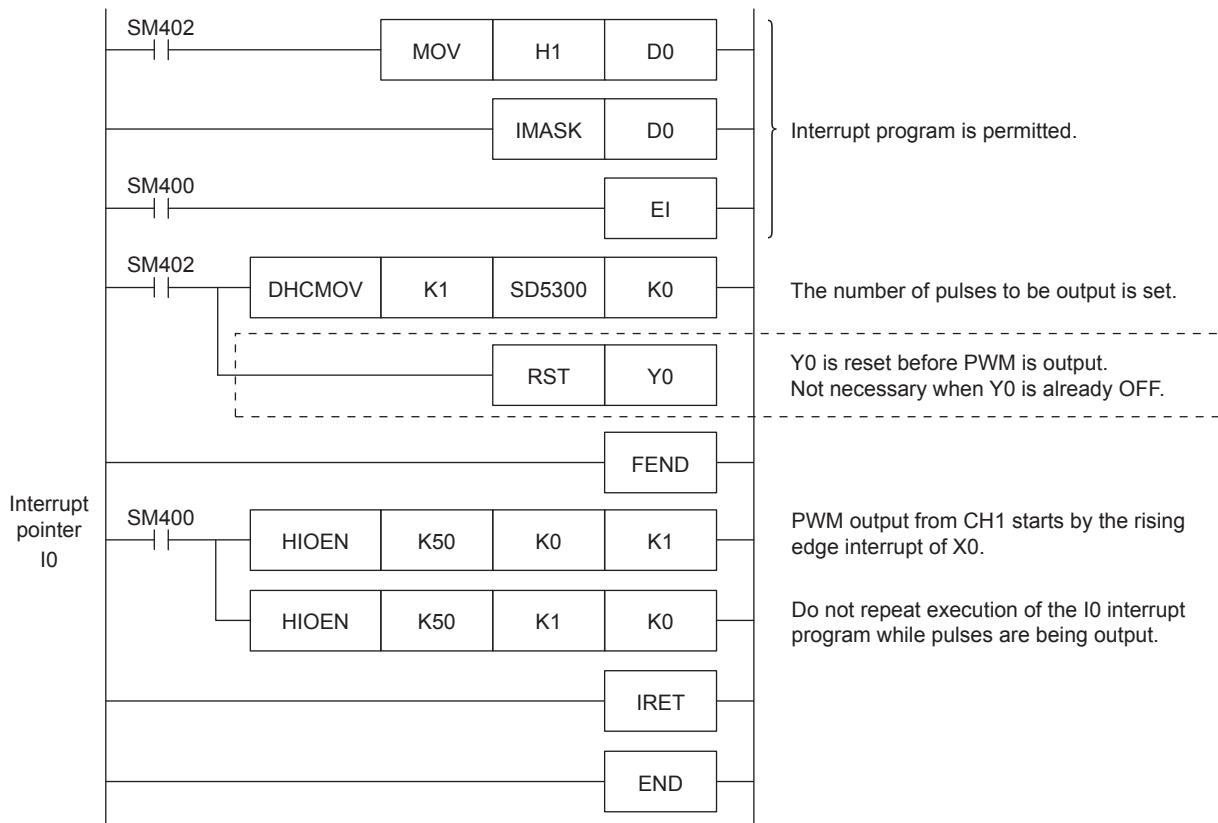

Precautions

- PWM in the same channel as an ongoing PWM execution cannot be executed by the alternate of the PWM/DPWM instruction and HIOEN/DHIOEN instruction. However, the PWM operation that is already in execution continues.
- If a channel with invalid PWM output parameters is executed by HIOEN/DHIOEN instruction, the PWM output is not executed.
- In a program with interruption priority 1, the HIOEN/DHIOEN or PWM/DPWM instruction to start or stop PWM output of the high-speed pulse input/output module (CH5 to CH12) cannot be executed. (☞ Page 75 Interrupt priority)

27 BUILT-IN ANALOG FUNCTION

The analog I/O terminal functions built into the FX5U CPU module are explained below.

27.1 Function Outline

There are two lines of analog voltage input and one line of analog voltage output built into the FX5U CPU module.

Functions must be configured using parameters to use the built-in analog circuits.

The values resulting from A/D conversion by the FX5U CPU module are automatically written in special registers for each channel.

By setting values into the special registers in the FX5U CPU module, the signal after D/A conversion is automatically output. For details on the function, refer to the following manual.

📖 MELSEC iQ-F FX5 User's Manual (Analog Control - CPU module builtin, Expansion adapter)

27.2 Analog Input/Output Specifications

Analog input/output specification is shown below.

Analog input specifications

Item		Specifications
No. of analog input points		2 points (2 channels)
Analog input	Voltage	0 to 10 V DC (input resistance 115.7 kΩ)
Digital output		Unsigned 12-bit binary
Device allocation		SD6020 (A/D-converted input data of CH1) SD6060 (A/D-converted input data of CH2)
Input characteristics, max. resolution	Digital output value	0 to 4000
	Max. resolution	2.5 mV
Precision (Precision for the full scale digital output value)	Ambient temperature 25 ±5°C	Within ±0.5% (±20 digit ^{*2})
	Ambient temperature 0 to 55°C	Within ±1.0% (±40 digit ^{*2})
	Ambient temperature -20 to 0°C ^{*1}	Within ±1.5% (±60 digit ^{*2})
Conversion speed		30 μs /CH (data refreshed every operation cycle)
Absolute max. input		-0.5 V, +15 V
Insulation method		Inside the CPU module and the analog input circuit are not insulated. Between input terminals (channels) is not insulated.
No. of occupied input/output points		0 point (does not pertain to the max. No. of input/output points of the CPU module.)

*1 This specification does not apply to products manufactured before June 2016.

*2 "Digit" refers to digital values.

Analog output specifications

Item		Specifications
No. of analog output points		1 point (1 channel)
Digital input		Unsigned 12-bit binary
Analog output	Voltage	0 to 10 V DC (external load resistance 2 k to 1 MΩ)
Device allocation		SD6180 (Output setting data)
Output characteristics, max. resolution ^{*1}	Digital input value	0 to 4000
	Max. resolution	2.5 mV
Precision ^{*2} (Precision for the full scale analog output value)	Ambient temperature 25 ±5°C	Within ±0.5% (±20 digit ^{*4})
	Ambient temperature 0 to 55°C	Within ±1.0% (±40 digit ^{*4})
	Ambient temperature -20 to 0°C ^{*3}	Within ±1.5% (±60 digit ^{*4})
Conversion speed		30 μs (data refreshed every operation cycle)
Insulation method		Inside the CPU module and the analog output circuit are not insulated.

Item	Specifications
No. of occupied input/output points	0 point (does not pertain to the max. No. of input/output points of the CPU module.)

- *1 There is a dead band near 0 V output, which is an area where some digital input values do not reflect analog output values.
- *2 External load resistance is set to 2 kΩ when shipped from the factory. Thus, output voltage will increase somewhat if the resistance is set higher than 2 kΩ. When the resistance is 1 MΩ, output voltage increases by a maximum 2%.
- *3 This specification does not apply to products manufactured before June 2016.
- *4 "Digit" refers to digital values.

List of analog input functions

List of Functions	Description	
Function to enable/disable A/D conversion	Function to enable or disable A/D conversion per channel. The conversion process time can be reduced by disabling conversion for unused channels.	
A/D conversion method	Sampling processing	Method of converting each analog input at END processing to generate the equivalent digital output.
	Count average	Method of averaging the count of A/D conversion values and outputting these average values as the digital signal.
	Time average	Method of averaging the time of A/D conversion values and outputting these average values as the digital signal.
	Moving average	Method of averaging the analog input for a specified count measured at every END process, and outputting these average values as the digital signal.
Function to detect over-scale	Function to detect analog input values that are over a specified range.	
Scaling function	Function that converts user-defined maximum and minimum digital values in accordance with a configured scale.	
Shift function	Function that adds a specified amount to the A/D conversion value. Fine adjustments during system startup can be easily performed.	
Digital clipping function	Function that specifies the maximum A/D conversion value as 4000 and the minimum value as 0 when voltage is input that exceeds the input range.	
Function to hold minimum and maximum values	Function that holds the minimum and maximum digital operation values.	
Warning output function	Function to output warning when digital operation values exceed the specified range.	
Event history function	Collects occurred errors and alarms in a functions of the built into analog, and stores them as event information into the CPU module.	

List of analog output functions

List of Functions	Description
Function to enable/disable D/A conversion	Function to enable or disable D/A conversion. When analog output is not used, the conversion process time can be reduced by disabling conversion.
Function to enable/disable D/A output	Specifies whether to output the D/A conversion value or output an offset value (HOLD setting value).
Scaling function	Function that converts user-defined maximum and minimum digital values in accordance with a configured scale.
Shift function	Function that adds a specified amount to the digital value. Fine adjustments during system startup can be easily performed.
Function to HOLD/CLEAR the analog output	Sets the digital value before D/A conversion to the previous value or clears the value (0) depending on the operation status of the CPU module (RUN, STOP, and STOP error).
Analog test when the CPU module has stopped	Outputs a user-defined analog value by setting the output enable/disable flag to enabled when the CPU module is stopped, and changing the digital value.
Warning output function	Function to output warning when digital values exceed the specified range.
Event history function	Collects occurred errors and alarms in a functions of the built into analog, and stores them as event information into the CPU module.

PART 3

DEVICES/LABELS

This part consists of the following chapters.

28 DEVICES

29 LABELS

28 DEVICES

This chapter explains devices.

28.1 List of Devices

A list of devices is provided below.

Division	Type	Device name	Symbol	Notation
User device	Bit	Input	X	Octal
	Bit	Output	Y	Octal
	Bit	Internal relay	M	Decimal
	Bit	Latch relay	L	Decimal
	Bit	Link relay	B	Hexadecimal number
	Bit	Annunciator	F	Decimal
	Bit	Link special relay	SB	Hexadecimal number
	Bit	Step relay	S	Decimal
	Bit/word	Timer	T (Contact: TS, Coil: TC, Current value: TN)	Decimal
	Bit/word	Retentive timer	ST (Contact: STS, Coil: STC, Current value: STN)	Decimal
	Bit/word	Counter	C (Contact: CS, Coil: CC, Current value: CN)	Decimal
	Bit/Double word	Long counter	LC (Contact: LCS, Coil: LCC, Current value: LCN)	Decimal
	Word	Data register	D	Decimal
	Word	Link register	W	Hexadecimal number
	Word	Link special register	SW	Hexadecimal number
System device	Bit	Special relay	SM	Decimal
	Word	Special register	SD	Decimal
Module access device (U□\G□)	Word	Module access device	G	Decimal
Index register	Word	Index register	Z	Decimal
	Double word	Long index register	LZ	Decimal
File registers	Word	File registers	R	Decimal
	Word	Extended file register	ER	Decimal
Nesting	—	Nesting	N	Decimal
Pointer	—	Pointer	P	Decimal
	—	Interrupt pointer	I	Decimal
SFC*1	—	SFC block device	BL	Decimal
	—	SFC transition device	TR	Decimal
Constant	—	Decimal constant	K	Decimal
	—	Hexadecimal constant	H	Hexadecimal number
	—	Real constant	E	—
	—	Character string constant	—	—

*1 Only FX5U/FX5UC CPU module is supported.

Point

Specify code of timer/retentive timer/counter/long counter by T/ST/C/LC if type is determined like instruction when specifying device. If type is not determined, specify by code from among contact, coil or current value according to type. Current value can however also be specified by T/ST/C/LC.

28.2 User Devices

This section explains user devices.

Input (X)

Provides the CPU module with commands and data by external devices such as push buttons, selector switches, limit switches, digital switches, etc.

Push-button switch



Selector switch



Digital switch

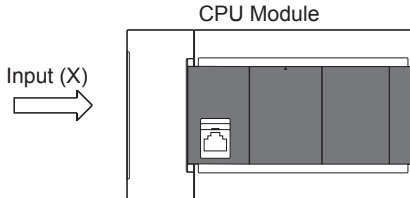
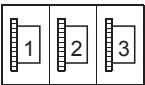

Concept of input

You can think each input point as having a virtual relay Xn built into a single CPU module. The program uses NO/NC contact of Xn.

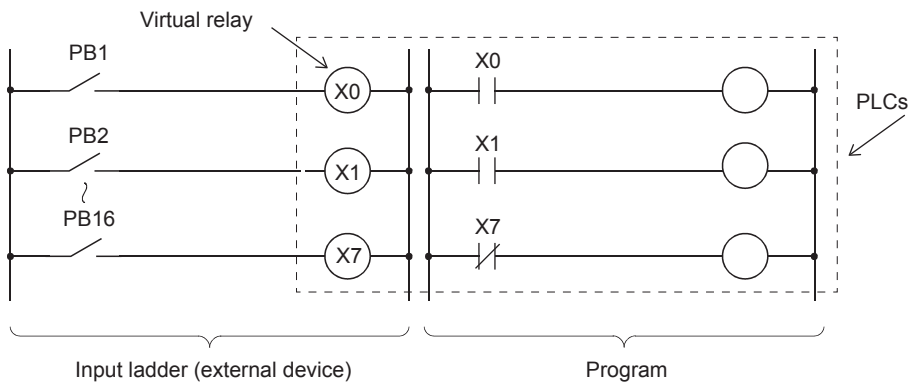

Output (Y)

Outputs program control results to external signal lamps, digital indicators, contactors, solenoids, etc.

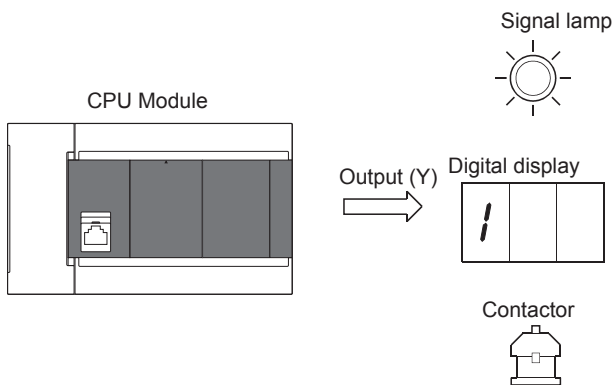

Internal relay (M)

Device intended to be used as an auxiliary relay inside the CPU module. All internal relays are turned OFF by the following operation.

- CPU module power OFF→ON
- Reset
- Latch clear

Latch relay (L)

Auxiliary relay that can latch (backup by battery) in the CPU module. Computation results (ON/OFF information) are latched even when performing the following operations.

- CPU module power OFF→ON
- Reset

Link relay (B)

Device intended to be used as a CPU side device when refreshing bit data between CPU module and network module.

Refreshing network module that uses link relay (B)

Sends/receives data mutually between network module link relays (LB) and link relay (B) in the CPU module. Set refresh range by parameters of the network module. Link relays not used for refresh can be used for other purposes.

Annunciator (F)

Internal relay used for program for detecting equipment errors/faults created by the user. When the annunciator (F) is turned ON, SM62 (Annunciator (F) Detection) turns ON, and the number of annunciator devices that are ON and their numbers are stored from SD62 (Annunciator (F) Detection No.) to SD79 (Annunciator (F) Detection No. Table).

Fault detection program

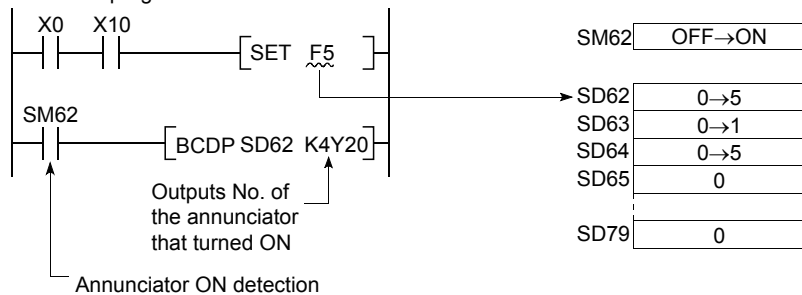

How to turn annunciator (F) ON

Use SET F□ instruction. The annunciator (F) turns ON only during the rise time of input conditions (OFF→ON); the annunciator (F) remains ON even if the input condition is OFF.

Point

- The annunciator (F) can also be turned ON by OUT F□ instruction, but because it is processed every scan, scan time is slower than when using SET F□ instruction.
- If it is turned ON by means other than SET F□ instruction or OUT F□ instruction (e.g. MOV instruction), operation is the same as for internal relay. Thus, in SM62 does not turn ON, and annunciator (F) numbers are not stored in SD62 and SD64 (Annunciator (F) Detection No. table) to SD79.

Processing when annunciator (F) is ON

Data stored in the special register becomes as follows.

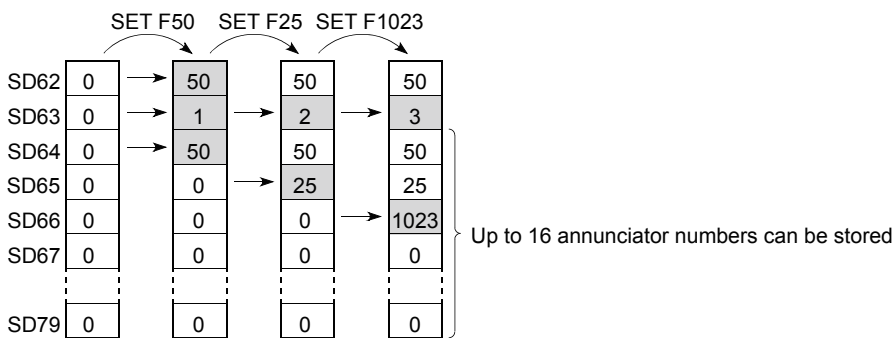

1. Annunciator (F) numbers that are ON are stored in SD64 to SD79 in sequence.
2. Annunciator (F) numbers that are stored in SD64 are stored in SD62.
3. Increments contents of SD63 (Annunciator (F) Detection Number) by +1.

Point

If 17 or more annunciator's are ON, the numbers are not stored in SD64 to SD79.

How to turn annunciator (F) OFF

Annunciators (F) are turned OFF by the following instruction.

Instruction	Application
RST F□ instruction	Used to turn OFF annunciator (F) number set by SET F□ instruction.
BKRST instruction	Used to turn a specified range of annunciator (F) numbers OFF in a batch.

Point

You can turn OFF by OUT F□ as well, but "Processing when annunciator (F) is OFF" described below is not carried out even if annunciator numbers are turned OFF by OUT F□ instruction. If annunciator (F) numbers are turned OFF by OUT F□ instruction, you must execute the RST F□/BKRST instruction given above.

■ Processing when annunciator (F) is OFF

Data stored in the special register becomes as follows.

- Data stored in SD62 to SD79 when RST F□ instruction or BKRST instruction is executed
1. Annunciator (F) numbers specified in the RST F□ instruction or the BKRST instruction are erased, and annunciator (F) numbers stored subsequent to those erased are moved up.
 2. If annunciator (F) numbers stored in SD64 are turned OFF, new annunciator (F) numbers stored in SD64 are stored in SD62.
 3. Decrements contents of SD63 by -1. If SD63 is "0", SM62 is turned OFF.

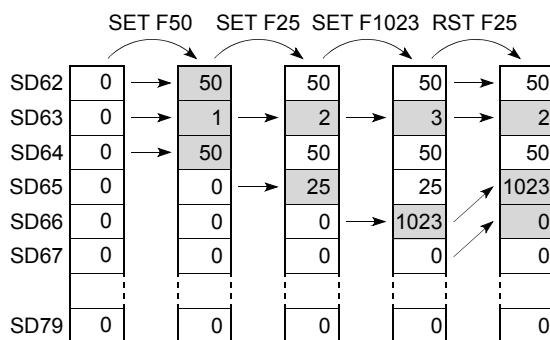

Link special relay (SB)

Communication and error detection status of network modules are output to link special relays within the network. Link special relays (SB) are devices intended to be used as a refresh destination for link special relays within the network. Link special relays not used for refresh can be used for other purposes.

Step relay (S)

Device to perform process stepping control. Purposes are as follows. Device which is not used can be used for purposes such as auxiliary relay.

- Step ladder (MELSEC iQ-F FX5 Programming Manual (Instructions, Standard Functions/Function Blocks))
- SFC program (MELSEC iQ-F FX5 Programming Manual (Program Design))
- Specifies a step.
- SFC control instruction
- Specifies a step No. to check the SFC program (monitor and change of the current value) by the engineering tool.

Timer (T/ST)

Device whereby measurement starts when the timer coil is turned ON, time up occurs when current value reaches the setting value, and the contact is turned ON. The timer is an addition type counter. When time is up, the current value and setting value are the same value.

Types of timers

There are timers (T) for which current value is maintained in 16 bits, and retentive timers (ST) that maintain the current value even when the coil is turned OFF.*1

*1 Current value of timers (T) becomes "0" when the coil is turned OFF.

■Timer (T)

Measurement starts when the timer's coil is turned ON. Time up occurs when the current value of the timer matches the setting value and the timer's contact is turned ON. When the timer's coil is turned OFF, the current value becomes "0" and the timer's contact is turned OFF.

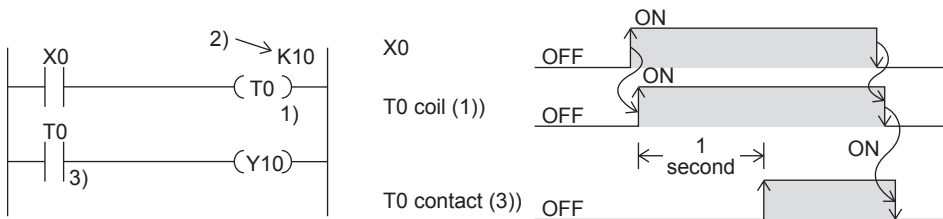

■Retentive timer (ST)

Measures time for which the coil is ON. Measurement starts when the retentive timer's coil is turned ON, and when the current value matches the setting value (time up), the retentive timer's contact is turned ON. The current value and ON/OFF status of the contact are maintained even if the retentive timer's coil is turned OFF. When the coil is turned back ON, measurement resumes from the current value maintained. The current value is cleared and the retentive timer is turned OFF by the RST ST□ instruction.

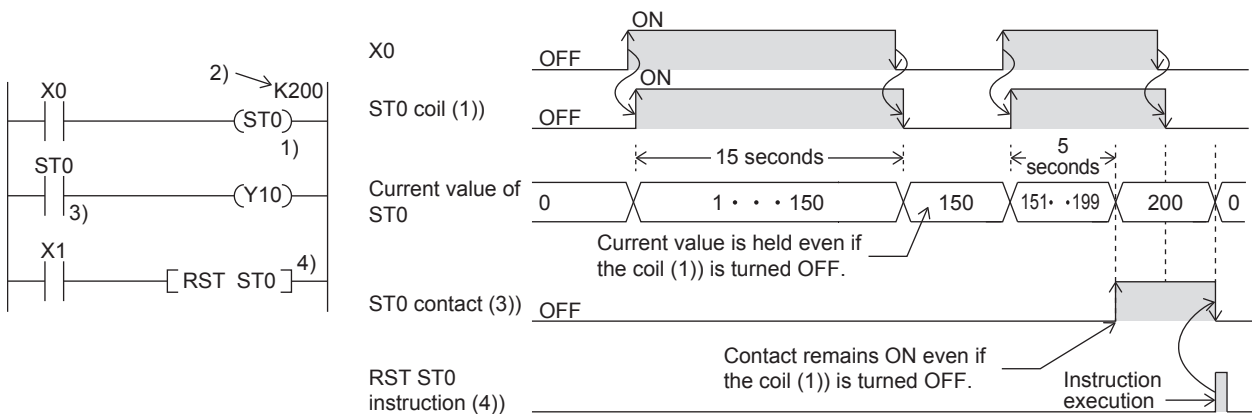

■Low-speed timer/Timer/High-speed timer (T/ST)

Low-speed timers, timers and high-speed timers are the same device. The timer is specified (by instruction) as a low-speed timer, timer, or high-speed timer. If for example, you specify "OUT T0," the timer is a low-speed timer (100 ms); if you specify "OUTH T0," it is a timer (10 ms); if you specify "OUTHHS T0," it is a high-speed timer (1 ms). The same goes for retentive timers.

■Routine timer (T)

The routine timer is a timer (100ms) that can operate even with a program that is not necessarily executed with every scan. Eight timers can be used at the maximum. This timer counts when the OUT T□ instruction, the ANS instruction, or the END instruction is executed.

To use a routine timer, it is necessary to set the parameter. (Page 357 Routine timer setting)

Current value and measurement range of timer

■Timer

The current value range is 0 to 32767.

Timer processing method

The timer's coil is turned ON/OFF, the current value is updated and the contact is turned ON/OFF when timer's coil (OUT T□ instruction) is executed.

Details on timer operation and timer accuracy

A timer (T/ST) starts counting when a coil is driven, and its output contact turns on when the first coil instruction is executed after the timer has reached timeout.

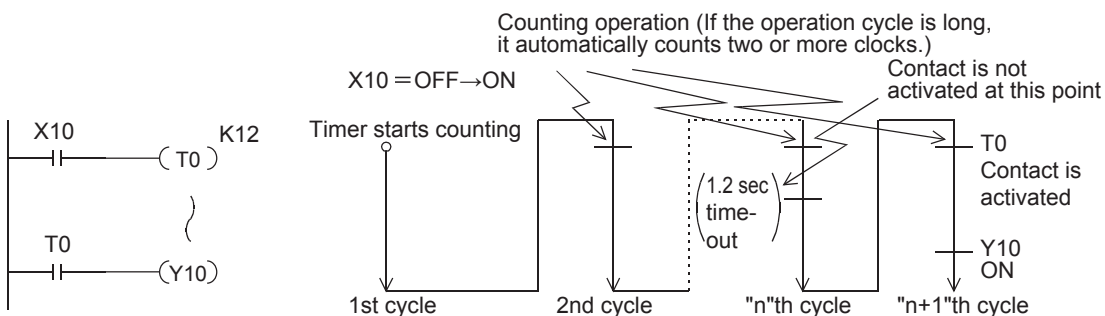

As shown in the above operation diagram, the accuracy of operation of the timer contact after the coil is driven until the contact turns on is shown in the following outline:

$T + T_0$ α : 0.001 sec (timer for 1 ms), 0.01 sec (timer for 10 ms) or 0.1 sec (timer for 100 ms)
 $- \alpha$ T : Timer set value (sec)
 T₀ : Operation cycle (sec)

If the contact is programmed before the timer coil, "+2T₀" is obtained in the worst case.

When the timer set value is "0", the output contact turns on when a coil instruction is executed in the next cycle.

The difference between a timer and a routine timer

Described below is the difference between a timer and a routine timer.

Item	Timer	Routine timer
Resolution	100 ms/10 ms /1 ms	100 ms
The timing of counting (count up)	When the OUT T□ instruction or the ANS instruction is executed	<ul style="list-style-type: none"> When the OUT T instruction or the ANS instruction is executed If the OUT T instruction or the ANS instruction is not executed, the counting starts when the END instruction is executed.
The timing of time up (the operation at the output contact)	When the OUT T□ instruction or the ANS instruction is executed	<ul style="list-style-type: none"> When the OUT T instruction or the ANS instruction is executed When the END instruction is executed
Device	T, ST	T

Precautions when using timers

Precautions when using timers are as follows.

- Do not specify the same timer coil (OUT T□ instruction) more than once per scan. If you do, the current value of the timer is updated when each respective timer coil is executed, so measurement cannot be performed normally.
- If timer is not executed each scan: You cannot skip a timer coil (OUT T□ instruction) with the CJ instruction, etc., while the timer's (T1 for example) coil is ON. If a timer's coil is skipped, the timer's current value is not updated, so measurement cannot be performed normally. If a timer (T1 for example) exists within a subroutine program, be sure to execute the subroutine coil that includes the T1 coil only once per scan while that timer's coil is ON. If not executed, measurement cannot be performed normally.
- The timer cannot be used in the initial execution type program, fixed scan execution type program, or event execution type program. The timer can be used in standby type programs if the coil of timer (OUT T□ instruction) is executed one time for one scan using a subroutine program.
- The timer cannot be used in interrupt programs. The timer can be used in subroutine programs or FB programs if the coil of timer (OUT T□ instruction) is executed one time for one scan.
- If setting value is "0": The output contact operates when the coil instruction of the next cycle is executed.
- If setting value is modified after time up: The timer remains in time up status and does not operate even if the setting value is raised higher than the current value after time up.

Routine timer setting

The setting of the routine timer is made.

Navigation window ⇒ [Parameter] ⇒ [FX5UJCPU] or [FX5UCPU] ⇒ [CPU Parameter] ⇒ "Memory/Device Setting" ⇒ "Device/Label Memory Area Setting"

Window

Item	Setting
Device/Label Memory Area Detailed Setting	
Device (high speed) Setting	<Detailed Setting>
Device (Standard) Setting	<Detailed Setting>
Latch type setting of the latch relay (L)	Latch (1)
Latch Label Latch Type	Latch (1)
Latch area of the latch label	Standard Latch Area
To use or not to use the routine timer of timer (T)	Not Use
Start device No. of routine timer of timer (T)	0

Displayed items

Item	Description	Setting range	Default
To use or not to use the routine timer of timer (T)	Whether the routine timer is used is set.	<ul style="list-style-type: none"> • Not use • Use 	Not use
Start device No. of routine timer of timer (T)	The initial device of the routine timer is set.	<ul style="list-style-type: none"> ■ FX5UJ CPU module • 0 to 511 ■ FX5U/FX5UC CPU module • 0 to 1023 	0

Counter (C/LC)

Device that counts number of rises of input conditions in the program. Counters are addition type counters; they count up when the count value matches the setting value, and the contact is turned ON.

For details on the FX3-compatible high-speed counter, refer to [Page 292 FX3-compatible high-speed counter function](#).

Counter type

There is counter (C) that maintains the counter value in 16 bits and the long counter (LC) that maintains the counter value in 32 bits. Counter (C) and long counter (LC) are separate devices. You can set number of device points for each. However, for FX5UJ CPU module, the number of device points is fixed.

■Counter (C)

Uses 1 word as 1 point. The counting range is from 0 to 32767.

■Long counter (LC)

Uses 2 words as 1 point. The counting range is from 0 to 4294967295.

Count processing

Count processing is as follows when counter's coil is executed.

■When the OUT C□ instruction/OUT LC□ instruction is executed

The counter's coil is turned ON/OFF, the current value is updated (count value +1) and contact ON/OFF processing is executed.

■Current value update (count value +1)

Current value is updated (count value +1) when counter coil input rises (OFF→ON). Current value is not updated when coil input is OFF, ON, or turned ON→OFF.

[Ladder example]



[Current value update timing]

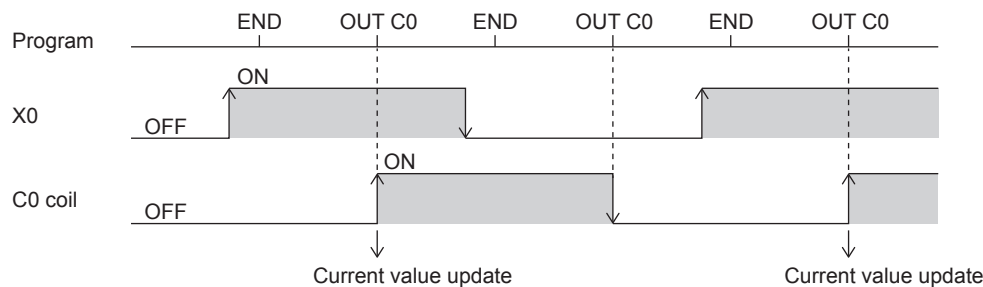

Counter reset

Current value of counters is not cleared even if its coil input is turned OFF. To clear (reset) the current value of the counter and turn the contact OFF, use the RST C□ instruction/RST LC□ instruction. The counter value is cleared and the contact is turned OFF as soon as the RST C□ instruction is executed.

[Ladder example]

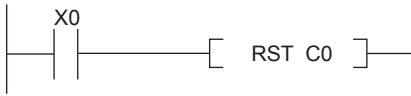

[Counter reset timing]

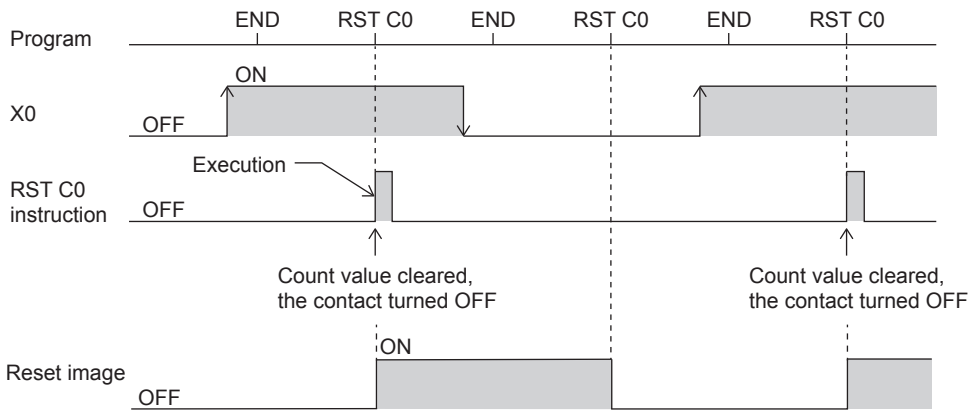

Precautions when performing counter reset

- When a counter is reset by the RST instruction, it cannot count until the RST instruction is set to OFF.

[Program example]

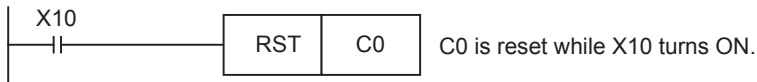

[Timing chart]

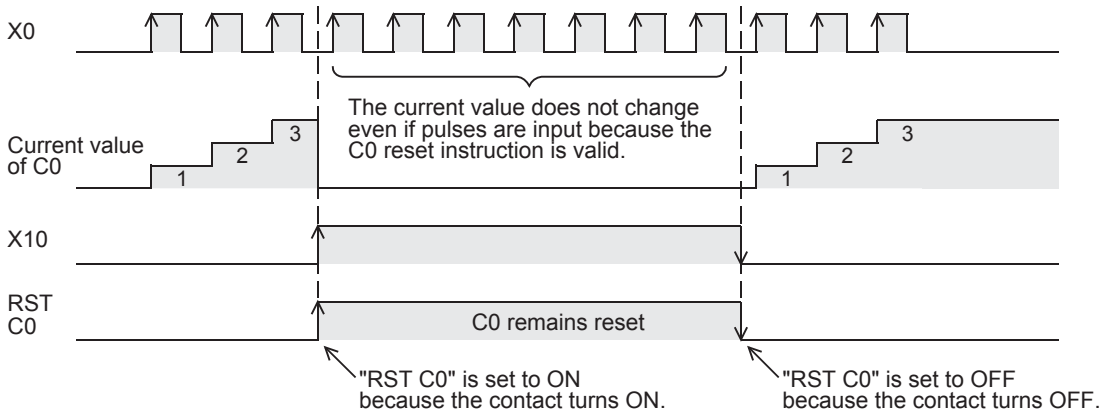

- When the counter is set as a latch device, the current value of a counter, output contact operation, and the reset image are latched.
- If the ZRST instruction is used, the RST image of a counter is reset.

Data register (D)

Device capable of storing numerical data.

Link register (W)

Device intended to be used as a CPU side device when refreshing word data between CPU module and network module.

Refreshing network module that uses link register (W)

Sends/receives data mutually between link registers (LW) in network module and link register (W) in the CPU module. Set refresh range by parameters of the network module. Link registers not used for refresh can be used for other purposes.

Link special register (SW)

Word data such as communication and error detection status information of network modules is output to link special relays within the network. Link special registers (SW) are devices intended to be used as a refresh destination for link special registers within the network. Link special registers not used for refresh can be used for other purposes.

28.3 System Devices

System devices are devices for the system. Assignment/capacity are fixed and cannot be changed by the user.

Special relay (SM)

The PLC contains internal relays with fixed specifications, so it cannot be used in the program like a conventional internal relay. It can however be turned ON/OFF to control the CPU module as needed. ( Page 376 Special Relay List)

Special register (SD)

The PLC contains internal register with fixed specifications, so it cannot be used in the program like a conventional internal register. Data, however, can be written to control the CPU module as needed. ( Page 410 Special Register List)

28.4 Module Access Device

Device that allows you to directly access the buffer memory of intelligent function modules connected to the CPU module from the CPU module.

Specification method

Specified by U [module number of intelligent function modules]\[buffer memory address].

(Example: U5\G11)

Processing speed

Processing speed of reading/writing by module access device is faster than using FROM/TO instruction. (Example: MOV U2\G11 D0) When reading the buffer memory of a module access device and executing another process by 1 instruction, the processing speed would be approximately the total of processing speed of FROM/TO instruction and processing speed of instruction. (Example: +U2\G11 D0 D10)

Point

If reading/writing data of the buffer memory using module access device at least 2 times in the program, you can speed up processing time by reading/writing at a single place in the program using a FROM/TO instruction.

- Writing using multiple module access devices

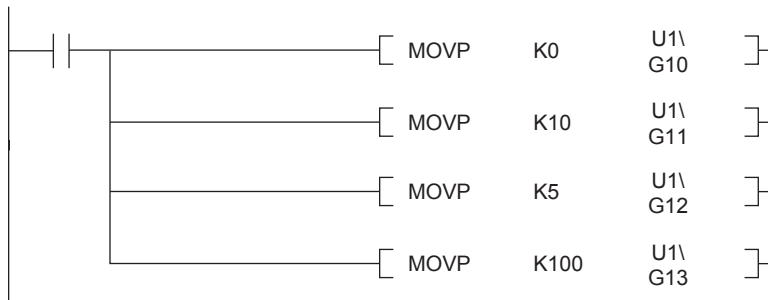

- Writing at single place in program using TO instruction

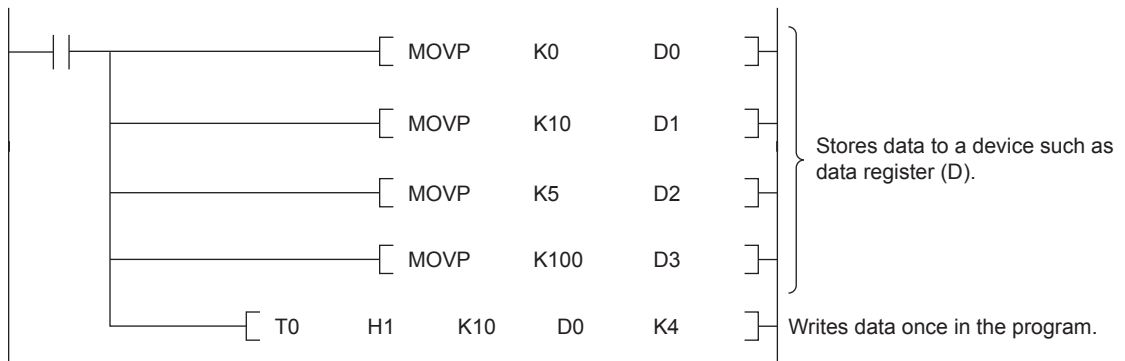

Precautions

- If module access device is used in an interrupt program with the priority 1, operation error (3580H) occurs. Module access device operates in an interrupt program with the priority 2 or 3.
- When FROM/TO instruction is executed in an interrupt program to an FX3 intelligent function module that is connected to the bus conversion module or later, operation error (3580H) occurs.

28.5 Index Registers (Z/LZ)

Device used for indexing of devices.

Types of index registers

There are 2 types: the index register (Z) and long index register (LZ)

Index register (Z)

Used for 16-bit index modification.

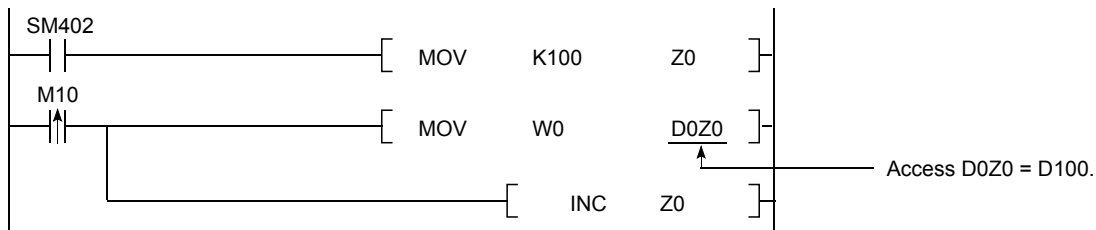

Long index register (LZ)

Used for 32-bit index modification.

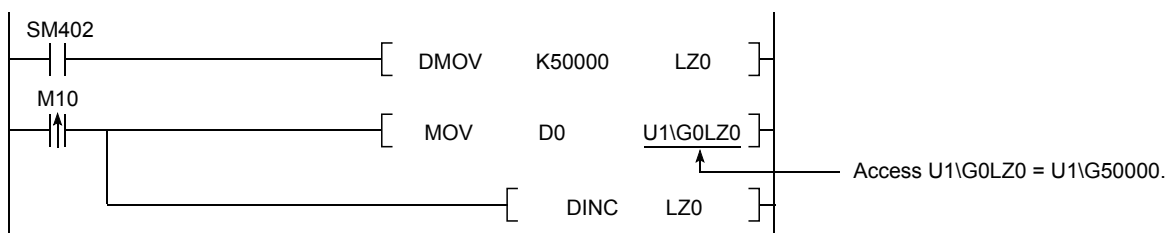

Device for which Index modification can be performed

The following table lists the devices that can be targeted for index modification.

Item	Description
Index modification by the index register (Z)	All devices
Index modification by the long index register (LZ)	U□\G, K, H

Index register setting

A total of 24 words can be used for index register (Z) and long index register (LZ). FX5U/FX5UC CPU module can change the number of points by parameter.

Navigation window ⇒ [Parameter] ⇒ [FX5UCPU] ⇒ [CPU Parameter] ⇒ "Memory/Device Setting" ⇒ "Index Register Setting"

Window

Item	Setting
Index Register Setting	
Points Setting	
Total Points	24 Word
Index Register (Z)	20 Points
Long Index Register (LZ)	2 Points

Displayed items

Item	Description	Setting range	Default
Total Points	Show the total number of points for index register and long index register.	—	—
Index Register (Z)	Set the number of points for index registers.	<ul style="list-style-type: none"> ■FX5UJ CPU module • 20 points (fixed) ■FX5U/FX5UC CPU module • 0 to 24 points (2 point unit) 	20 points
Long Index Register (LZ)	Set the number of points for long index registers.	<ul style="list-style-type: none"> ■FX5UJ CPU module • 2 points (fixed) ■FX5U/FX5UC CPU module • 0 to 12 points (1 point unit) 	2 points

28.6 File Register (R/ER)

Device capable of storing numerical data.

Types of file register

There are 2 types: the file register (R) and extended file register (ER)

File register (R)

The device held in the CPU built-in memory.

Extended file register (ER)

The device held only in the SD memory card. The extended file register (ER) function can be used with the programs (dedicated instructions) or GX Works3.

Point

- For supported version of extended file register (ER), refer to  Page 566 Added and Enhanced Functions.
- Extended file register (ER) can be used only when the SD memory card is inserted to the CPU module.

Extended file register (ER) function

Function to use the program (dedicated instructions)

Extended file register (ER) functions that can be used by applied instructions are shown below.

- ERREAD instruction: Reading function of extended file register (ER)
- ERWRITE instruction: Writing (transfer) function of extended file register (ER)
- ERINIT instruction: Batch initialization function of extended file register (ER)

For each applied instruction, refer to  MELSEC iQ-F FX5 Programming Manual (Instructions, Standard Functions/Function Blocks).

Point

Extended file register (ER) function is not applicable to the file register (R) stored into the SD memory card by the memory dump function.

■Reading function of extended file register (ER)

The current value of the extended file register (ER) stored into the SD memory card can be read from the file register (R) in the CPU built-in memory by using ERREAD instruction.

The device number of data transfer source and data transfer destination is the same number. (When ER0 to 100 are read, the values are stored to R0 to 100.) In using the ERREAD instruction, the maximum number of device points which can be read from the extended file register (ER) is 32768.

■Writing (transfer) function of extended file register (ER)

The current value of the file register (R) in the CPU built-in memory can be written (transferred) to the extended file register (ER) in the SD memory card by using ERWRITE instruction.

The device number of data transfer source and data transfer destination is the same number. (When R0 to 100 are written, the values are stored to ER0 to 100.) In using the ERWRITE instruction, the maximum number of device points which can be written to the extended file register (ER) is 32768.

■Batch initialization function of extended file register (ER)

All the points of the extended file register (ER) in the SD memory card can be initialized in a batch by using ERINIT instruction.

If all the points of the file register (R) in the CPU built-in memory are initialized, you must write K0 by ERREAD instruction, etc..

Function to use the GX Works3

Extended file register (ER) functions that can be used by GX Works3 are shown below.

- Data batch reading function
- Data batch writing function
- Data batch initialization (clearing values) function
- Data batch initialization (memory initialization) function

For operation of GX Works3, refer to  GX Works3 Operating Manual.

Point

- Extended file register (ER) function by GX Works3 cannot specify the target device points; instead, all of the device points become the target.
- The device memory in the project of GX Works3, and the file register (R) in the CPU built-in memory and SD memory card will not be updated by these functions.

■Data batch reading function

All the current values of the extended file register (ER) stored into the SD memory card can be read from the device memory in the project of GX Works3 (extended file register (ER)) in a batch.

 [Online] ⇒ [Read from PLC]

Window

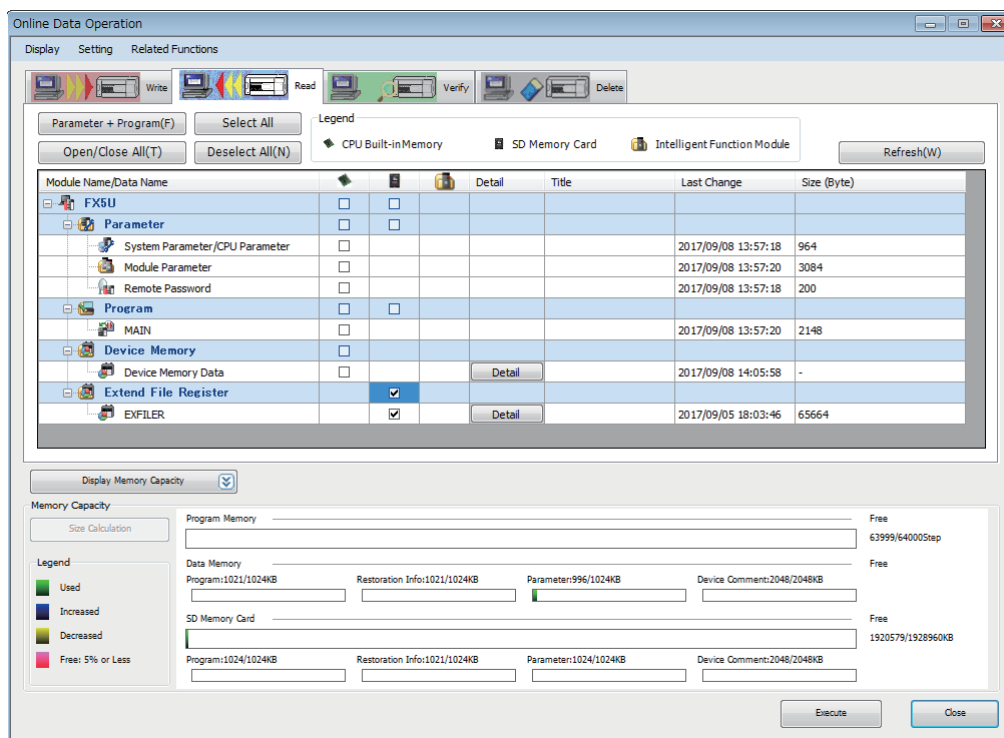

Check the "Extended File Register" box under SD memory card, execute read, and the current value of the extended file register (ER) in the SD memory card will be stored to the device memory in the project of GX Works3 (extended file register (ER)).

All the points (32768 points) of the extended file register (ER) in the SD memory card are read from the device memory in the project of GX Works3 without depending on the user's device point setting of the file register (R). ( Page 124 Device Setting)

■Data batch writing function

All the value registered to the device memory in the project of GX Works3 (extended file register (ER)) can be written to the extended file register (ER) in the SD memory card in a batch.

 [Online] ⇄ [Write to PLC]

Window

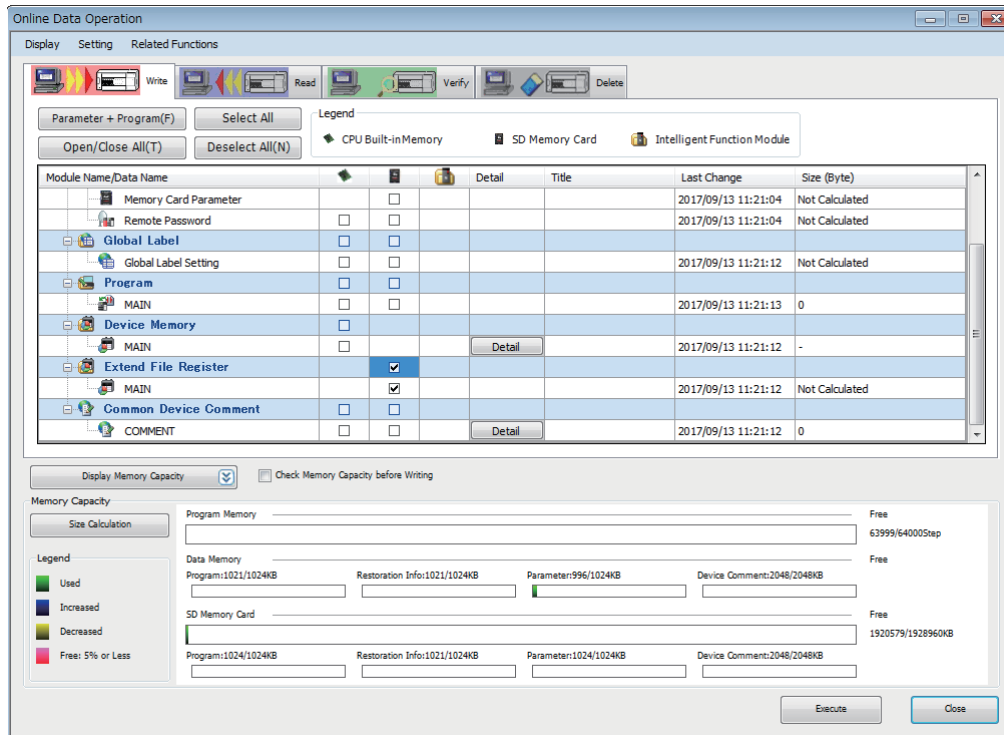

Check the "Extended File Register" box under SD memory card, execute write, and the value of the device memory in the project of GX Works3 (extended file register (ER)) will be stored to the extended file register (ER) in the SD memory card. All the points (32768 points) of the device memory in the project of GX Works3 are written to the extended file register (ER) in the SD memory card without depending on the user's device point setting of the file register (R). ( Page 124 Device Setting)

■Data batch initialization (clearing values) function

All of the extended file register (ER) in the SD memory card can be cleared from GX Works3 in a batch.

 [Online] ⇒ [CPU Memory Operation]

Window

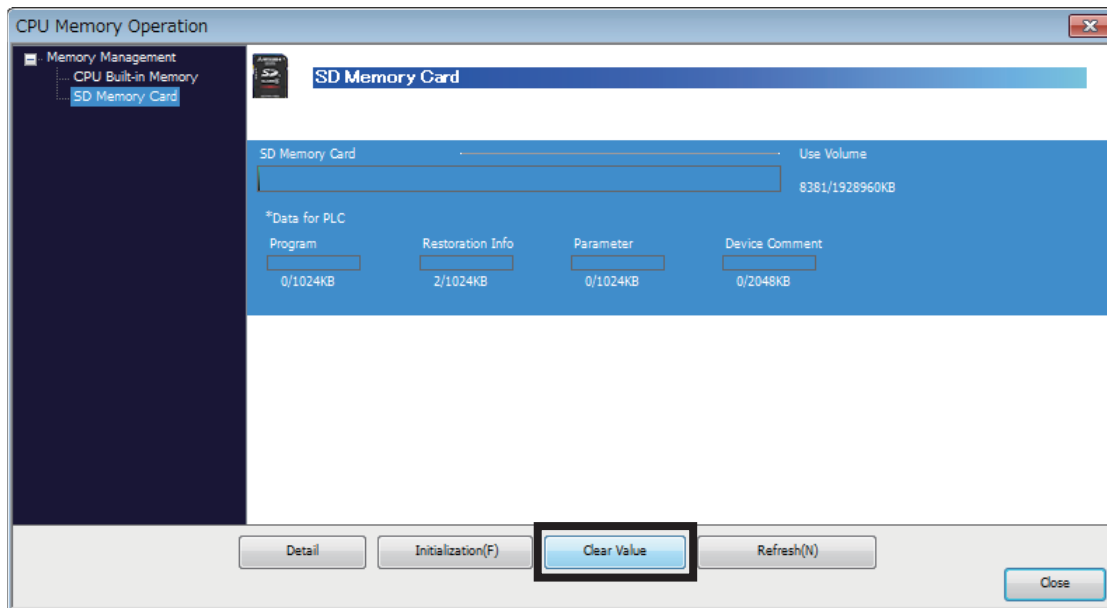

Switch the screen to the memory operation screen of the SD memory card, select [Clear Value], and the extended file register (ER) in the SD memory card is initialized.

■Data batch initialization (memory initialization) function

The extended file register (ER) in the SD memory card can be initialized (formatted) from GX Works3. However, in addition to the extended file register (ER), all of the folders and files in the SD memory card are formatted.

 [Online] ⇒ [CPU Memory Operation]

Window

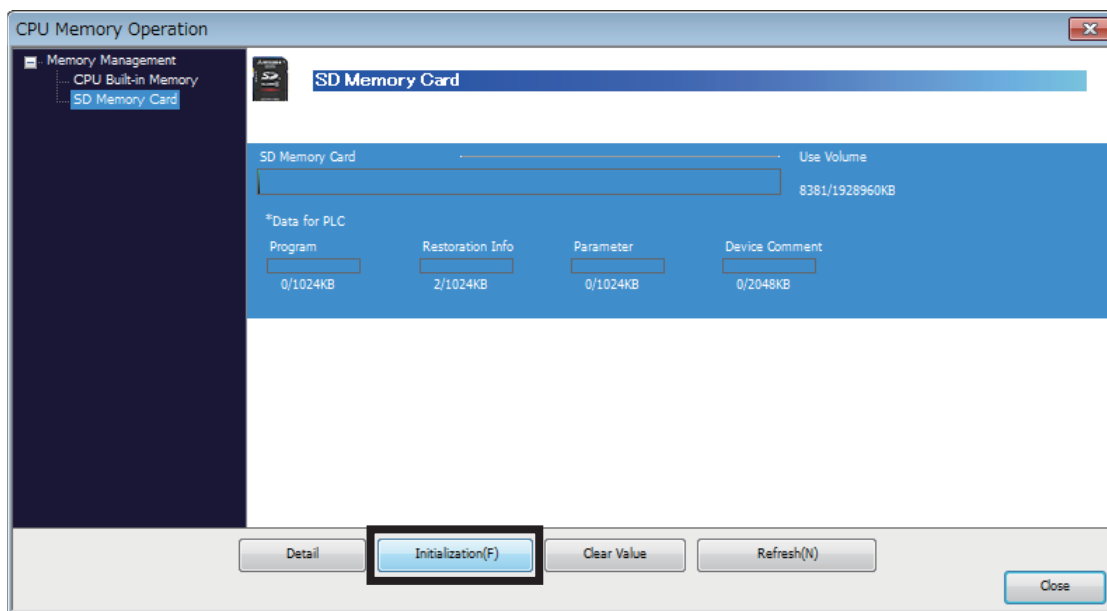

Switch the screen to the memory operation screen of the SD memory card, select [Initialization], and all of the data in the SD memory card including the extended file register (ER) is initialized.

28.7 Nesting (N)

Device for programming operating conditions by nesting using master control instructions (MC/MCR instruction)^{*1}. Operation conditions are specified in ascending order (N0 to N14) from outside the nesting.

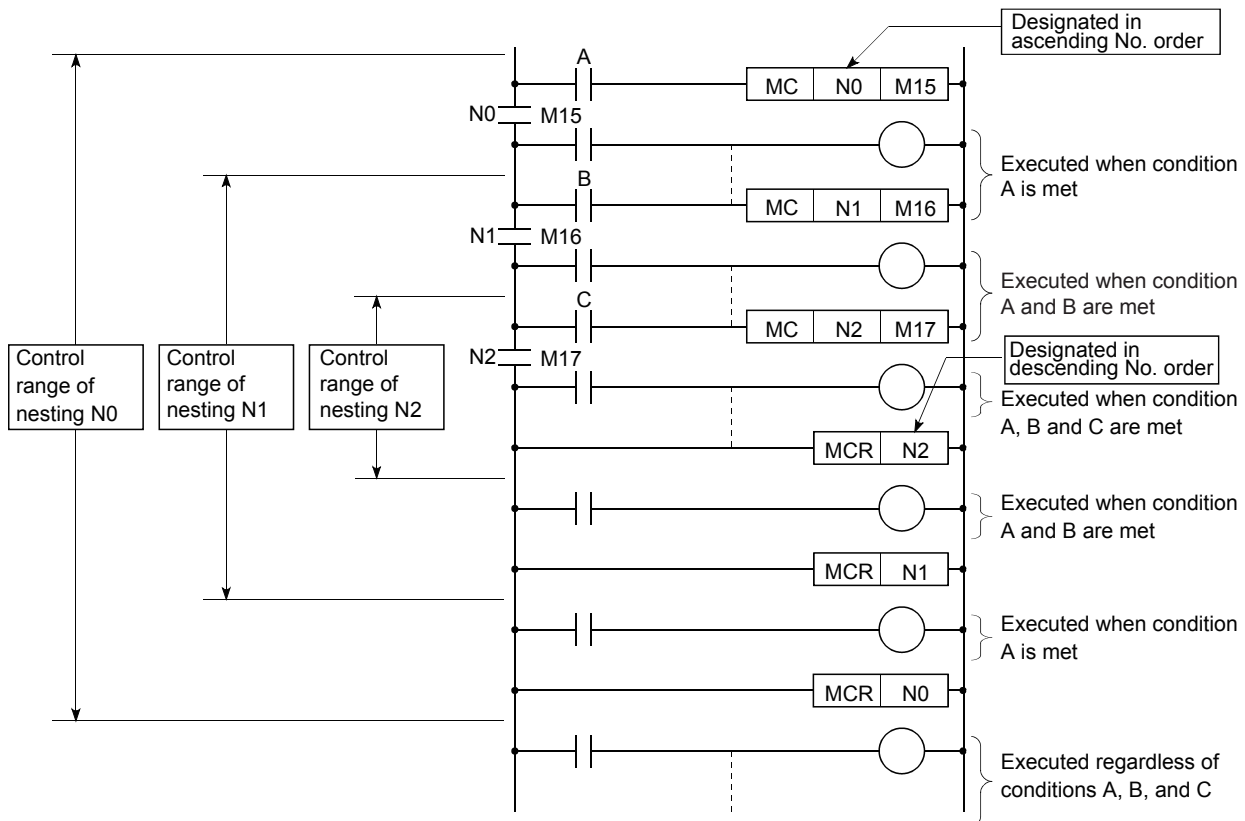

*1 Instruction for creating an efficient circuit switching program by switching common bus of the circuit.

28.8 Pointer (P)

Device used by instructions such as jump instruction (CJ instruction) and subroutine program call instruction (CALL instruction, etc.). Types of pointers are as follows.

Pointer	Description
Global pointers	Pointers that can be referred to from all programs.
Label assignment pointers	Pointers used by assignment to labels. Pointer numbers assigned to labels are automatically determined by engineering tool; the user cannot specify pointer numbers to be assigned.

Pointers are used for the following purposes.

- Specifies label and where to jump to for jump instruction (CJ instruction).
- Specifies label (top of subroutine program) and call destination of subroutine instruction (CALL instruction, etc.).

Global pointers

Pointer for calling subroutine from all programs being run.

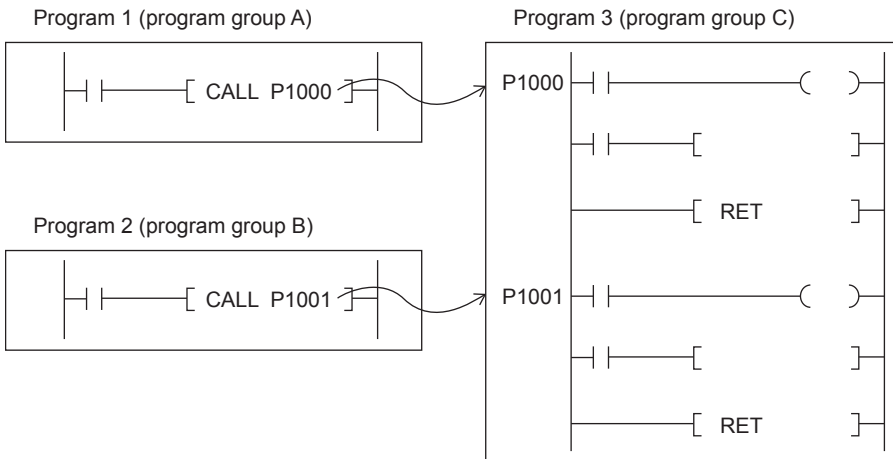

Precautions when using global pointers

- A global pointer of the same pointer number cannot be set as a label for more than one location.
- The initial pointer number for global pointers is fixed to "0".

Label assignment pointers

Pointer assigned to pointer type labels. Pointer for label assignment are automatically assigned to pointer type labels by engineering tool. Pointer numbers of pointers for label assignment cannot be directly specified. By defining pointer type labels, you can specify destination for jump instruction or subroutine program by label instead of pointer such as P0.

28.9 Interrupt Pointer (I)

Device used as label at top of interrupt program. Can be used by all running programs.

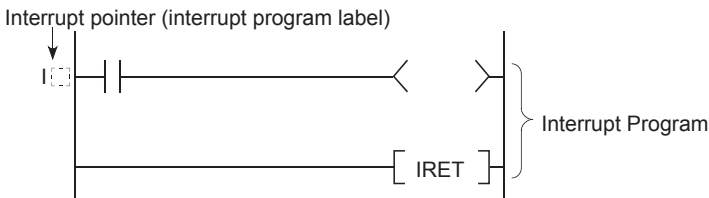

Point

Setting the execution type of program to the event execution type eliminates the need to write (I□) the interrupt pointer. (Page 28 Generation of interrupt by interrupt pointer (I))

Interrupt causes of the interrupt pointer numbers

A list of interrupts is provided below.

Interrupt	Interrupt pointer number	Description
Input interrupt	I0 to I15	interrupt pointer used for input interrupt of CPU module. Up to 8 points can be used.
High-speed comparison match interrupt	I16 to I23	Interrupt pointer used for high-speed comparison match interrupt of CPU module.
Interrupt by internal timer	I28 to I31	Interrupt pointer used for fixed cycle interrupt by internal timer.
Interrupt from module	I50 to I177	Interrupt pointer used for a module that has interrupt function.

The priority for the interrupt pointer numbers and interrupt factors

The priority for the interrupt pointer numbers and interrupt factors are indicated.

Interrupt pointer number	Interruption cause	Interrupt priority	Interrupt priority order	Remarks
I0	Input interrupt (Input terminal: X0 to X17)	1 to 3	1	The default value for priority is "2". X0 to X17 are assigned as I0 to I15.
I1				
I2				
I3				
I4				
I5				
I6				
I7				
I8				
I9				
I10				
I11				
I12				
I13				
I14				
I15				
I16	High-speed comparison match interrupt	1 to 3	17	The default value for priority is "2".
I17				
I18				
I19				
I20				
I21				
I22				
I23				
I28	Interrupt by internal timer	1 to 3	28	The default value for priority is "2".
I29				
I30				
I31				
I50 to I177	Interrupt from module	2 to 3	29 to 156	The default value for priority is "2". The highest priority rank is I50 and the lowest is I177.

Point 

- The interrupt priority is the order which is executed at the time of the multiple interrupt. The lower the numerical value, the higher the interrupt priority.
- The interrupt priority order is the order which is executed when the interrupt factor with the same interrupt priority is generated.

28.10 SFC Block Device (BL)

This device is used when specifying SFC program blocks. This device is also used when specifying step No. through such methods as verifying (monitor, current value changes) SFC programs with SFC control instructions or the engineering tool. (MELSEC iQ-F FX5 Programming Manual (Program Design))

Point

To start the SFC block device for the SFC program while ON/OFF information of the SFC block device (BD) are maintained (continuation start), an option battery is required.

28.11 SFC Transition Device (TR)

This device is used when specifying SFC program transition conditions. This device can only be used for device comments for transition conditions. (MELSEC iQ-F FX5 Programming Manual (Program Design))

28.12 Indirect Specification

Specify the device using the indirect address of device. Store the indirect address of device to be specified into the device for indirect specification, and write as "@ + Device for indirect specification".

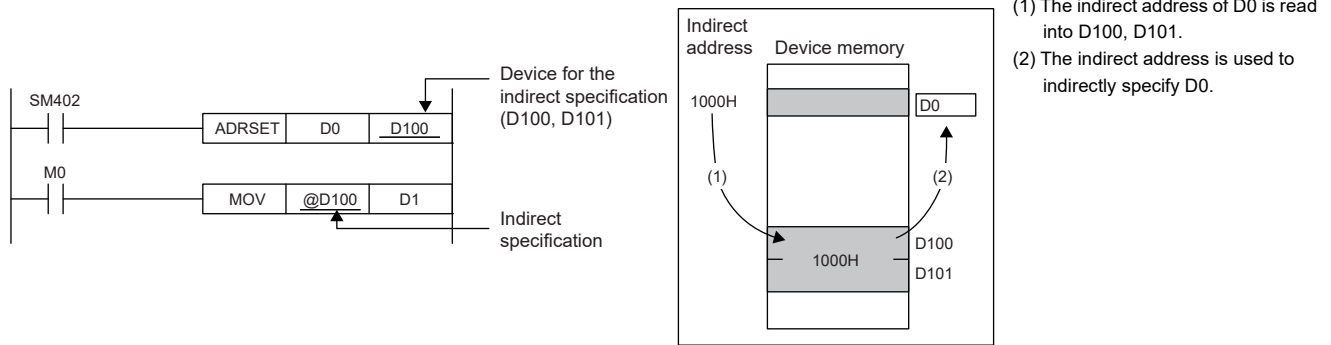

The indirect specification can be used in the device/label memory.

Indirect address of device

To specify, use the 32-bit data, and to hold the value, use the device of two words. The indirect address of the device can be obtained with the ADRSET instruction. The ADRSET instruction specifies the indirect address of the device using instructions that handle 32-bit data. For the ADRSET instruction, refer to the following.

(MELSEC iQ-F FX5 Programming Manual (Instructions, Standard Functions/Function Blocks))

Devices that can allow indirect specification

This section lists devices that can allow indirect specification.

Type	Device*1
Devices that can allow indirect specification where @ is added	D, W, SW, SD, U□V, R
Device that can acquire the indirect address through the ADRSET instruction	D, W, SW, SD, R

*1 Devices that cannot be used as operands of instructions cannot be used even when they are indirectly specified.

28.13 Constant

This section explains constants.

Decimal constant (K)

Device that specifies decimal data for the program. Specified by K□. (Example: K1234)

The specification range is determined by type of argument data of instruction using a decimal constant.

Argument data type of instruction		Specification range of decimal constants
Data size	Data type name	
16 bits	Word (signed)	K-32768 to K32767
	Word (unsigned)/Bit string (16-bit)	K0 to K65535
32 bits	Double word (signed)	K-2147483648 to K2147483647
	Double word (unsigned)/Bit string (32-bit)	K0 to K4294967295

Hexadecimal constant (H)

Device that specifies hexadecimal data for the program. Specified by H□. (Example: H1234)

When specifying BCD data, specify each digit of hexadecimal number in 0 to 9. The specification range is determined by type of argument data of instruction using a hexadecimal constant. If data size is 16 bits, H0 to HFFFF; if 32 bits, H0 to HFFFFFFFF.

Real constant (E)

Device that specifies real numbers for the program. Specified by E□. (Example: E1.234)

Setting range of real numbers

The setting range of real numbers is explained below.

$$-2^{128} \leq \text{Device} \leq -2^{-126}, 0, 2^{-126} \leq \text{Device} \leq 2^{128}$$

(E-3.40282347+38 to E-1.17549435-38, 0, E1.17549435-38 to E3.40282347+38)

Operation during calculation

■ Operation at overflow and underflow

Operation is as follows if overflow or underflow occurs during calculation.

- Overflow: Error occurs.
- Underflow: Becomes "0" without error occurring.

■ Operation when special value^{*1} is input

If calculation is performed when input data is a special value, an error occurs. If "-0" occurs during calculation, it is treated as "+0"; the calculation result does not become "-0".

*1 Special values are -0, denormalized numbers, non-numbers, ±∞.

Programming expressions

Real numbers can be specified by the following expressions.

- Normal expression: Specify a numeric value as it is. (Example: E10.2345 in the case of 10.2345)
- Scientific notation: Specify a numeric value in the format "numeric value" ×10ⁿ. (Example: E1.234+3 in the case of 1234. "+3" represents "10³".)

Character string constant

The character string can be specified by enclosing it with single quotation marks (' ') or double quotation marks (" "). (Example: "ABCDE") Note that the NULL character^{*1} becomes the termination character.

- *1 Character string: 00H
Unicode character string: 0000H

Point

For details on character string data, refer to the following.

 MELSEC iQ-F FX5 Programming Manual (Instructions, Standard Functions/Function Blocks)

29 LABELS

Label is identifier (character string) that specifies a character string in I/O data or internal processing. When a label is used in programming, a program can be created without being conscious about the device No. ^{*1}

*1 Label and device can be used in mixed manner.



For details on label, refer to the following.

 MELSEC iQ-F FX5 Programming Manual (Program Design)

MEMO

APPENDIX

Appendix 1 Special Relay List

Diagnostic information

The special relays for diagnostic information are shown below.

○: Supported, ×: Not supported

R: Read only, R/W: Read/Write

No.	Name	Description	Function support		R/W
			FX5UJ	FX5U/ FX5UC	
SM0	Latest self diagnostics error (including annunciator ON)	OFF: No error ON: Error	○	○	R
SM1	Latest self diagnostics error (not including annunciator On)	OFF: No self-diagnosis errors ON: Self-diagnosis error	○	○	R
SM50	Error reset	OFF→ON: Error reset request ON→OFF: Error reset completion	○	○	R/W
SM51	Battery low latch	OFF: Normal ON: Battery low	×	○	R
SM52	Battery low	OFF: Normal ON: Battery low	×	○	R
SM53	AC/DC DOWN	OFF: No AC/DC down detection ON: AC/DC down is detected	○	○	R
SM56	Instruction execution fault	OFF: Normal ON: Operation error	○	○	R
SM61	I/O module verify error	OFF: Normal ON: Error	○	○	R
SM62	Annunciator	OFF: Not detected ON: Detected	○	○	R
SM80	Detailed information 1: Flag in use	OFF: Not used ON: In use	○	○	R
SM112	Detailed information 2: Flag in use	OFF: Not used ON: In use	○	○	R

System information

The special relays for system information are shown below.

○: Supported, ×: Not supported

R: Read only, R/W: Read/Write

No.	Name	Description	Function support		R/W
			FX5UJ	FX5U/ FX5UC	
SM203	STOP contact	OFF: Other than STOP state ON: STOP state	○	○	R
SM204	PAUSE contact	OFF: Other than PAUSE state ON: PAUSE state	○	○	R
SM210	Clock data set request	OFF→ON: Set Request ON→OFF: Set completed	○	○	R/W
SM211	Clock data set error	OFF: No error ON: Error	○	○	R
SM213	Clock data read request	OFF: Ignored ON: Read request	○	○	R/W

SFC information

The following is a list of special relay areas relating to SFC information.

○: Supported, ×: Not supported

R: Read only, R/W: Read/Write

No.	Name	Description	Function support		R/W
			FX5UJ	FX5U/ FX5UC	
SM320	Presence/absence of SFC program	OFF: No SFC program ON: SFC program	×	○	R
SM321	Start/stop SFC program	OFF: SFC program not executed (stop) ON: SFC program executed (start)	×	○	R/W
SM322	SFC program startup status	OFF: Initial start ON: Resumption	×	○	R/W
SM323	Presence/absence of continuous transition for entire block	OFF: No continuous transition ON: Continuous transition	×	○	R/W
SM324	Continuous transition prevention flag	OFF: When transition executed ON: When there is no transition	×	○	R
SM327	Output mode at execution of the END step	OFF: Hold step output off ON: Hold step output retained	×	○	R/W
SM328	Clear processing mode when the sequence reaches the END step	OFF: Clear processing performed ON: Clear processing not performed	×	○	R/W
SM4301	FX3 compatible transition operation mode setting status	OFF: Disabled ON: Enabled	×	○	R

System clock





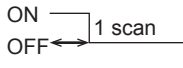
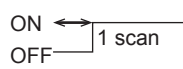
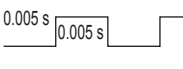
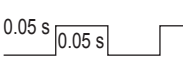
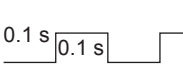
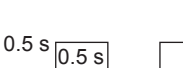

The special relay about system clock is shown below.

○: Supported, ×: Not supported

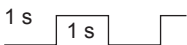
R: Read only, R/W: Read/Write

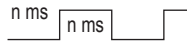
No.	Name	Description	Function support		R/W
			FX5UJ	FX5U/ FX5UC	
SM400	Always ON	ON _____ OFF	○	○	R
SM401	Always OFF	ON _____ OFF _____	○	○	R
SM402	After RUN, ON for one scan only	ON 	○	○	R
SM403	After RUN, OFF for one scan only	ON 	○	○	R
SM409	0.01 second clock		○	○	R
SM410	0.1 second clock		○	○	R
SM411	0.2 second clock		○	○	R
SM412	1 second clock		○	○	R

A

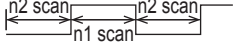
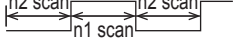
No.	Name	Description	Function support		R/W
			FX5UJ	FX5U/ FX5UC	
SM413	2 second clock		○	○	R
SM414	2n second clock		○	○	R
SM415	2n millisecond clock		○	○	R
SM420	Timing clock output 1		○	○	R
SM421	Timing clock output 2		○	○	R
SM422	Timing clock output 3		○	○	R
SM423	Timing clock output 4		○	○	R
SM424	Timing clock output 5		○	○	R

Drive information

The special relays for drive information are shown below.

○: Supported, ×: Not supported

R: Read only, R/W: Read/Write

No.	Name	Description	Function support		R/W
			FX5UJ	FX5U/ FX5UC	
SM600	Memory card usable	OFF: Unusable ON: Use enabled	○	○	R
SM601	Memory card protect	OFF: Not protected ON: Protected	○	○	R
SM603	Memory card insertion	OFF: No drive 2 ON: Drive 2 present	○	○	R
SM605	Memory card interchange protect	OFF: Remove/insert enabled ON: Remove/insert prohibited	○	○	R/W
SM606	Memory card disable request	OFF: Clear command ON: Command	○	○	R/W
SM607	Memory card disable status	OFF: Not disabled by SD memory card forced stop request ON: Disabled by SD memory card forced stop request	○	○	R
SM632	Data memory write error detection	OFF: Write not executed/normal ON: Write error	○	○	R
SM633	Data memory writing	OFF: Write not executed ON: Writing	○	○	R
SM634	Data memory write count error detection flag	OFF: Overwrite count is less than 20,000 ON: Overwrite count is 20,000 or more	○	○	R

Instruction related

The special relays related to instruction execution are shown below.

○: Supported, ×: Not supported

R: Read only, R/W: Read/Write

No.	Name	Description	Function support		R/W
			FX5UJ	FX5U/ FX5UC	
SM699	Dedicated instruction skip flag	OFF: Intelligent dedicated instruction executed ON: Intelligent dedicated instruction not executed	○	○	R/W
SM700	Carry flag	OFF: Carry OFF ON: Carry ON	○	○	R
SM701	Output characters selection	OFF: NULL code output ON: No change	○	○	R/W
SM703	Sort order	OFF: Ascending order ON: Descending order	○	○	R/W
SM704	Block comparison	OFF: Non-match found ON: All match	○	○	R
SM709	DT/TM instruction improper data detection	OFF: Improper data not detected ON: Improper data detected	○	○	R/W
SM753	File being accessed	OFF: Not in progress ON: In progress	○	○	R

Firmware update function

The special relays for firmware update function are shown below.

○: Supported, ×: Not supported

R: Read only, R/W: Read/Write

No.	Name	Description	Function support		R/W
			FX5UJ	FX5U/ FX5UC	
SM912	Firmware update prohibit state	OFF: Firmware update enable state ON: Firmware update prohibit state (Firmware update prohibited file is present)	○	○	R

Latch area

The special relays for latch area are shown below.

○: Supported, ×: Not supported

R: Read only, R/W: Read/Write

No.	Name	Description	Function support		R/W
			FX5UJ	FX5U/ FX5UC	
SM953	Data backup error check flag	OFF: No error ON: Error	○	○	R
SM959	Data restoration error check flag	OFF: No error ON: Error	○	○	R

A

Data logging function

The special relays for data logging function are shown below.

○: Supported, ×: Not supported

R: Read only, R/W: Read/Write

No.	Name	Description	Function support		R/W
			FX5UJ	FX5U/ FX5UC	
SM1201	SD memory card setting file in use flag	OFF: Not used ON: In use	○	○	R
SM1202	Data memory setting file in use flag	OFF: Not used ON: In use	○	○	R
SM1210	Data logging setting No.1 Data logging preparation	OFF: Not prepared ON: Prepared	○	○	R
SM1211	Data logging setting No.1 Data logging start	OFF: Suspended/waiting for start ON: Start	○	○	R
SM1212	Data logging setting No.1 Data logging data collection in progress	OFF: Not in progress ON: In progress	○	○	R
SM1213	Data logging setting No.1 Data logging completion	OFF: Not completed ON: Completed	○	○	R
SM1214	Data logging setting No.1 Data logging triggering	OFF→ON: Triggered	○	○	R
SM1215	Data logging setting No.1 Post data logging triggering	OFF: Not post triggering ON: Post triggering	○	○	R
SM1216	Data logging setting No.1 Data logging error	OFF: No error ON: Error	○	○	R
SM1217	Data logging setting No.1 Data logging data saving into memory card in progress	OFF: Not in progress ON: In progress	○	○	R
SM1218	Data logging setting No.1 Logging data storage file switching in progress	OFF: Not in progress ON: In progress	○	○	R
SM1220 to SM1228	Data logging setting No.2	Same configuration as the setting No.1	○	○	R
SM1230 to SM1238	Data logging setting No.3	Same configuration as the setting No.1	○	○	R
SM1240 to SM1248	Data logging setting No.4	Same configuration as the setting No.1	○	○	R
SM1312 to SM1315	Data logging setting No.1 to 4 Data logging suspend/resume flag	OFF→ON: Suspend ON→OFF: Resume	○	○	R/W

Data backup/restoration function

The special relays for data backup/restoration function are shown below.

○: Supported, ×: Not supported

R: Read only, R/W: Read/Write

No.	Name	Description	Function support		R/W
			FX5UJ	FX5U/ FX5UC	
SM1350	Data backup status flag	OFF: Not being executed ON: Being executed	○	○	R
SM1351	Data backup execution request	OFF→ON: Backup requested ON→OFF: Backup completed	○	○	R/W
SM1353	Data restoration status flag	OFF: Not being executed ON: Being executed	○	○	R
SM1354	Data restoration execution request	OFF→ON: Restoration requested ON→OFF: Restoration completed	○	○	R/W

File transfer function (FTP client)

The following is the list of special relay areas relating to the file transfer function (FTP client).

○: Supported, ×: Not supported

R: Read only, R/W: Read/Write

No.	Name	Description	Function support		R/W
			FX5UJ	FX5U/ FX5UC	
SM1392	FTP client connection status	OFF: Not connected (disconnected) ON: Connected	×	○	R

Memory dump function

The special relays for memory dump function are shown below.

○: Supported, ×: Not supported

R: Read only, R/W: Read/Write

No.	Name	Description	Function support		R/W
			FX5UJ	FX5U/ FX5UC	
SM1472	Memory dump in progress	OFF: Memory dump not executed ON: Memory dump in progress	○	○	R
SM1473	Memory dump completed	OFF: Not completed ON: Completed	○	○	R

CC-Link IE Field Network Basic function

The special relays for CC-Link IE Field Network Basic function are shown below.

○: Supported, ×: Not supported

R: Read only, R/W: Read/Write

No.	Name	Description	Function support		R/W
			FX5UJ	FX5U/ FX5UC	
SM1536	Cyclic transmission status	OFF: Not performed ON: Being performed	○	○	R
SM1540	Data link status	OFF: All stations normal ON: One or more faulty stations	○	○	R

FX high-speed input/output

The special relays for FX high-speed input/output are shown below.

○: Supported, ×: Not supported

R: Read only, R/W: Read/Write

No.	Name	Description	Function support		R/W
			FX5UJ	FX5U/ FX5UC	
SM4210	All module reset command	OFF: Disabled ON: Enabled (when SD4210 stores F5F5H)	×	○	R/W
SM4300	Event execution type program operation timing switch setting flag	OFF: Can be executed after initial execution type program operation ON: Can be executed in the same scan as initial execution type program operation	○	○	R/W
SM4493	File access adjustment setting	OFF: Disabled ON: Enabled	○	○	R/W
SM4496	Intelligent module latest error clear request	OFF: Error reset not requested ON: Error reset completion	○	○	R/W
SM4500	High-speed counter operation (CH1)	OFF: Stopped ON: Operation	○	○	R

A

No.	Name	Description	Function support		R/W
			FX5UJ	FX5U/ FX5UC	
SM4501	High-speed counter operation (CH2)	OFF: Stopped ON: Operation	○	○	R
SM4502	High-speed counter operation (CH3)	OFF: Stopped ON: Operation	○	○	R
SM4503	High-speed counter operation (CH4)	OFF: Stopped ON: Operation	○	○	R
SM4504	High-speed counter operation (CH5)	OFF: Stopped ON: Operation	○	○	R
SM4505	High-speed counter operation (CH6)	OFF: Stopped ON: Operation	○	○	R
SM4506	High-speed counter operation (CH7)	OFF: Stopped ON: Operation	○	○	R
SM4507	High-speed counter operation (CH8)	OFF: Stopped ON: Operation	○	○	R
SM4508	High-speed counter operation (CH9)	OFF: Stopped ON: Operation	×	○	R
SM4509	High-speed counter operation (CH10)	OFF: Stopped ON: Operation	×	○	R
SM4510	High-speed counter operation (CH11)	OFF: Stopped ON: Operation	×	○	R
SM4511	High-speed counter operation (CH12)	OFF: Stopped ON: Operation	×	○	R
SM4512	High-speed counter operation (CH13)	OFF: Stopped ON: Operation	×	○	R
SM4513	High-speed counter operation (CH14)	OFF: Stopped ON: Operation	×	○	R
SM4514	High-speed counter operation (CH15)	OFF: Stopped ON: Operation	×	○	R
SM4515	High-speed counter operation (CH16)	OFF: Stopped ON: Operation	×	○	R
SM4516	High-speed counter pulse density/Rotation speed measurement (CH1)	OFF: Stopped ON: Measurement	○	○	R
SM4517	High-speed counter pulse density/Rotation speed measurement (CH2)	OFF: Stopped ON: Measurement	○	○	R
SM4518	High-speed counter pulse density/Rotation speed measurement (CH3)	OFF: Stopped ON: Measurement	○	○	R
SM4519	High-speed counter pulse density/Rotation speed measurement (CH4)	OFF: Stopped ON: Measurement	○	○	R
SM4520	High-speed counter pulse density/Rotation speed measurement (CH5)	OFF: Stopped ON: Measurement	○	○	R
SM4521	High-speed counter pulse density/Rotation speed measurement (CH6)	OFF: Stopped ON: Measurement	○	○	R
SM4522	High-speed counter pulse density/Rotation speed measurement (CH7)	OFF: Stopped ON: Measurement	○	○	R
SM4523	High-speed counter pulse density/Rotation speed measurement (CH8)	OFF: Stopped ON: Measurement	○	○	R
SM4532	High-speed counter overflow (CH1)	OFF: No error ON: Overflow	○	○	R/W
SM4533	High-speed counter overflow (CH2)	OFF: No error ON: Overflow	○	○	R/W
SM4534	High-speed counter overflow (CH3)	OFF: No error ON: Overflow	○	○	R/W
SM4535	High-speed counter overflow (CH4)	OFF: No error ON: Overflow	○	○	R/W
SM4536	High-speed counter overflow (CH5)	OFF: No error ON: Overflow	○	○	R/W
SM4537	High-speed counter overflow (CH6)	OFF: No error ON: Overflow	○	○	R/W

No.	Name	Description	Function support		R/W
			FX5UJ	FX5U/ FX5UC	
SM4538	High-speed counter overflow (CH7)	OFF: No error ON: Overflow	○	○	R/W
SM4539	High-speed counter overflow (CH8)	OFF: No error ON: Overflow	○	○	R/W
SM4540	High-speed counter overflow (CH9)	OFF: No error ON: Overflow	×	○	R/W
SM4541	High-speed counter overflow (CH10)	OFF: No error ON: Overflow	×	○	R/W
SM4542	High-speed counter overflow (CH11)	OFF: No error ON: Overflow	×	○	R/W
SM4543	High-speed counter overflow (CH12)	OFF: No error ON: Overflow	×	○	R/W
SM4544	High-speed counter overflow (CH13)	OFF: No error ON: Overflow	×	○	R/W
SM4545	High-speed counter overflow (CH14)	OFF: No error ON: Overflow	×	○	R/W
SM4546	High-speed counter overflow (CH15)	OFF: No error ON: Overflow	×	○	R/W
SM4547	High-speed counter overflow (CH16)	OFF: No error ON: Overflow	×	○	R/W
SM4548	High-speed counter underflow (CH1)	OFF: No error ON: Underflow	○	○	R/W
SM4549	High-speed counter underflow (CH2)	OFF: No error ON: Underflow	○	○	R/W
SM4550	High-speed counter underflow (CH3)	OFF: No error ON: Underflow	○	○	R/W
SM4551	High-speed counter underflow (CH4)	OFF: No error ON: Underflow	○	○	R/W
SM4552	High-speed counter underflow (CH5)	OFF: No error ON: Underflow	○	○	R/W
SM4553	High-speed counter underflow (CH6)	OFF: No error ON: Underflow	○	○	R/W
SM4554	High-speed counter underflow (CH7)	OFF: No error ON: Underflow	○	○	R/W
SM4555	High-speed counter underflow (CH8)	OFF: No error ON: Underflow	○	○	R/W
SM4556	High-speed counter underflow (CH9)	OFF: No error ON: Underflow	×	○	R/W
SM4557	High-speed counter underflow (CH10)	OFF: No error ON: Underflow	×	○	R/W
SM4558	High-speed counter underflow (CH11)	OFF: No error ON: Underflow	×	○	R/W
SM4559	High-speed counter underflow (CH12)	OFF: No error ON: Underflow	×	○	R/W
SM4560	High-speed counter underflow (CH13)	OFF: No error ON: Underflow	×	○	R/W
SM4561	High-speed counter underflow (CH14)	OFF: No error ON: Underflow	×	○	R/W
SM4562	High-speed counter underflow (CH15)	OFF: No error ON: Underflow	×	○	R/W
SM4563	High-speed counter underflow (CH16)	OFF: No error ON: Underflow	×	○	R/W
SM4564	High-speed counter count direction monitor (CH1)	OFF: Up-counting ON: Down-counting	○	○	R
SM4565	High-speed counter count direction monitor (CH2)	OFF: Up-counting ON: Down-counting	○	○	R
SM4566	High-speed counter count direction monitor (CH3)	OFF: Up-counting ON: Down-counting	○	○	R

No.	Name	Description	Function support		R/W
			FX5UJ	FX5U/ FX5UC	
SM4567	High-speed counter count direction monitor (CH4)	OFF: Up-counting ON: Down-counting	○	○	R
SM4568	High-speed counter count direction monitor (CH5)	OFF: Up-counting ON: Down-counting	○	○	R
SM4569	High-speed counter count direction monitor (CH6)	OFF: Up-counting ON: Down-counting	○	○	R
SM4570	High-speed counter count direction monitor (CH7)	OFF: Up-counting ON: Down-counting	○	○	R
SM4571	High-speed counter count direction monitor (CH8)	OFF: Up-counting ON: Down-counting	○	○	R
SM4572	High-speed counter count direction monitor (CH9)	OFF: Up-counting ON: Down-counting	×	○	R
SM4573	High-speed counter count direction monitor (CH10)	OFF: Up-counting ON: Down-counting	×	○	R
SM4574	High-speed counter count direction monitor (CH11)	OFF: Up-counting ON: Down-counting	×	○	R
SM4575	High-speed counter count direction monitor (CH12)	OFF: Up-counting ON: Down-counting	×	○	R
SM4576	High-speed counter count direction monitor (CH13)	OFF: Up-counting ON: Down-counting	×	○	R
SM4577	High-speed counter count direction monitor (CH14)	OFF: Up-counting ON: Down-counting	×	○	R
SM4578	High-speed counter count direction monitor (CH15)	OFF: Up-counting ON: Down-counting	×	○	R
SM4579	High-speed counter count direction monitor (CH16)	OFF: Up-counting ON: Down-counting	×	○	R
SM4580	High-speed counter count switching (CH1) (1-phase 1-input S/W)	OFF: Up-counting ON: Down-counting	○	○	R/W
SM4581	High-speed counter count switching (CH2) (1-phase 1-input S/W)	OFF: Up-counting ON: Down-counting	○	○	R/W
SM4582	High-speed counter count switching (CH3) (1-phase 1-input S/W)	OFF: Up-counting ON: Down-counting	○	○	R/W
SM4583	High-speed counter count switching (CH4) (1-phase 1-input S/W)	OFF: Up-counting ON: Down-counting	○	○	R/W
SM4584	High-speed counter count switching (CH5) (1-phase 1-input S/W)	OFF: Up-counting ON: Down-counting	○	○	R/W
SM4585	High-speed counter count switching (CH6) (1-phase 1-input S/W)	OFF: Up-counting ON: Down-counting	○	○	R/W
SM4586	High-speed counter count switching (CH7) (1-phase 1-input S/W)	OFF: Up-counting ON: Down-counting	○	○	R/W
SM4587	High-speed counter count switching (CH8) (1-phase 1-input S/W)	OFF: Up-counting ON: Down-counting	○	○	R/W
SM4588	High-speed counter count switching (CH9) (1-phase 1-input S/W)	OFF: Up-counting ON: Down-counting	×	○	R/W
SM4589	High-speed counter count switching (CH10) (1-phase 1-input S/W)	OFF: Up-counting ON: Down-counting	×	○	R/W
SM4590	High-speed counter count switching (CH11) (1-phase 1-input S/W)	OFF: Up-counting ON: Down-counting	×	○	R/W
SM4591	High-speed counter count switching (CH12) (1-phase 1-input S/W)	OFF: Up-counting ON: Down-counting	×	○	R/W
SM4592	High-speed counter count switching (CH13) (1-phase 1-input S/W)	OFF: Up-counting ON: Down-counting	×	○	R/W
SM4593	High-speed counter count switching (CH14) (1-phase 1-input S/W)	OFF: Up-counting ON: Down-counting	×	○	R/W
SM4594	High-speed counter count switching (CH15) (1-phase 1-input S/W)	OFF: Up-counting ON: Down-counting	×	○	R/W
SM4595	High-speed counter count switching (CH16) (1-phase 1-input S/W)	OFF: Up-counting ON: Down-counting	×	○	R/W

No.	Name	Description	Function support		R/W
			FX5UJ	FX5U/ FX5UC	
SM4596	High-speed counter preset input logic (CH1)	OFF: Positive logic ON: Negative logic	○	○	R/W
SM4597	High-speed counter preset input logic (CH2)	OFF: Positive logic ON: Negative logic	○	○	R/W
SM4598	High-speed counter preset input logic (CH3)	OFF: Positive logic ON: Negative logic	○	○	R/W
SM4599	High-speed counter preset input logic (CH4)	OFF: Positive logic ON: Negative logic	○	○	R/W
SM4600	High-speed counter preset input logic (CH5)	OFF: Positive logic ON: Negative logic	○	○	R/W
SM4601	High-speed counter preset input logic (CH6)	OFF: Positive logic ON: Negative logic	○	○	R/W
SM4602	High-speed counter preset input logic (CH7)	OFF: Positive logic ON: Negative logic	○	○	R/W
SM4603	High-speed counter preset input logic (CH8)	OFF: Positive logic ON: Negative logic	○	○	R/W
SM4604	High-speed counter preset input logic (CH9)	OFF: Positive logic ON: Negative logic	×	○	R/W
SM4605	High-speed counter preset input logic (CH10)	OFF: Positive logic ON: Negative logic	×	○	R/W
SM4606	High-speed counter preset input logic (CH11)	OFF: Positive logic ON: Negative logic	×	○	R/W
SM4607	High-speed counter preset input logic (CH12)	OFF: Positive logic ON: Negative logic	×	○	R/W
SM4608	High-speed counter preset input logic (CH13)	OFF: Positive logic ON: Negative logic	×	○	R/W
SM4609	High-speed counter preset input logic (CH14)	OFF: Positive logic ON: Negative logic	×	○	R/W
SM4610	High-speed counter preset input logic (CH15)	OFF: Positive logic ON: Negative logic	×	○	R/W
SM4611	High-speed counter preset input logic (CH16)	OFF: Positive logic ON: Negative logic	×	○	R/W
SM4612	High-speed counter preset input comparison (CH1)	OFF: Disabled ON: Enabled	○	○	R/W
SM4613	High-speed counter preset input comparison (CH2)	OFF: Disabled ON: Enabled	○	○	R/W
SM4614	High-speed counter preset input comparison (CH3)	OFF: Disabled ON: Enabled	○	○	R/W
SM4615	High-speed counter preset input comparison (CH4)	OFF: Disabled ON: Enabled	○	○	R/W
SM4616	High-speed counter preset input comparison (CH5)	OFF: Disabled ON: Enabled	○	○	R/W
SM4617	High-speed counter preset input comparison (CH6)	OFF: Disabled ON: Enabled	○	○	R/W
SM4618	High-speed counter preset input comparison (CH7)	OFF: Disabled ON: Enabled	○	○	R/W
SM4619	High-speed counter preset input comparison (CH8)	OFF: Disabled ON: Enabled	○	○	R/W
SM4620	High-speed counter preset input comparison (CH9)	OFF: Disabled ON: Enabled	×	○	R/W
SM4621	High-speed counter preset input comparison (CH10)	OFF: Disabled ON: Enabled	×	○	R/W
SM4622	High-speed counter preset input comparison (CH11)	OFF: Disabled ON: Enabled	×	○	R/W
SM4623	High-speed counter preset input comparison (CH12)	OFF: Disabled ON: Enabled	×	○	R/W
SM4624	High-speed counter preset input comparison (CH13)	OFF: Disabled ON: Enabled	×	○	R/W

No.	Name	Description	Function support		R/W
			FX5UJ	FX5U/ FX5UC	
SM4625	High-speed counter preset input comparison (CH14)	OFF: Disabled ON: Enabled	×	○	R/W
SM4626	High-speed counter preset input comparison (CH15)	OFF: Disabled ON: Enabled	×	○	R/W
SM4627	High-speed counter preset input comparison (CH16)	OFF: Disabled ON: Enabled	×	○	R/W
SM4628	High-speed counter enable input logic (CH1)	OFF: Positive logic ON: Negative logic	○	○	R/W
SM4629	High-speed counter enable input logic (CH2)	OFF: Positive logic ON: Negative logic	○	○	R/W
SM4630	High-speed counter enable input logic (CH3)	OFF: Positive logic ON: Negative logic	○	○	R/W
SM4631	High-speed counter enable input logic (CH4)	OFF: Positive logic ON: Negative logic	○	○	R/W
SM4632	High-speed counter enable input logic (CH5)	OFF: Positive logic ON: Negative logic	○	○	R/W
SM4633	High-speed counter enable input logic (CH6)	OFF: Positive logic ON: Negative logic	○	○	R/W
SM4634	High-speed counter enable input logic (CH7)	OFF: Positive logic ON: Negative logic	○	○	R/W
SM4635	High-speed counter enable input logic (CH8)	OFF: Positive logic ON: Negative logic	○	○	R/W
SM4636	High-speed counter enable input logic (CH9)	OFF: Positive logic ON: Negative logic	×	○	R/W
SM4637	High-speed counter enable input logic (CH10)	OFF: Positive logic ON: Negative logic	×	○	R/W
SM4638	High-speed counter enable input logic (CH11)	OFF: Positive logic ON: Negative logic	×	○	R/W
SM4639	High-speed counter enable input logic (CH12)	OFF: Positive logic ON: Negative logic	×	○	R/W
SM4640	High-speed counter enable input logic (CH13)	OFF: Positive logic ON: Negative logic	×	○	R/W
SM4641	High-speed counter enable input logic (CH14)	OFF: Positive logic ON: Negative logic	×	○	R/W
SM4642	High-speed counter enable input logic (CH15)	OFF: Positive logic ON: Negative logic	×	○	R/W
SM4643	High-speed counter enable input logic (CH16)	OFF: Positive logic ON: Negative logic	×	○	R/W
SM4644	High-speed counter ring length (CH1)	OFF: Disabled ON: Enabled	○	○	R/W
SM4645	High-speed counter ring length (CH2)	OFF: Disabled ON: Enabled	○	○	R/W
SM4646	High-speed counter ring length (CH3)	OFF: Disabled ON: Enabled	○	○	R/W
SM4647	High-speed counter ring length (CH4)	OFF: Disabled ON: Enabled	○	○	R/W
SM4648	High-speed counter ring length (CH5)	OFF: Disabled ON: Enabled	○	○	R/W
SM4649	High-speed counter ring length (CH6)	OFF: Disabled ON: Enabled	○	○	R/W
SM4650	High-speed counter ring length (CH7)	OFF: Disabled ON: Enabled	○	○	R/W
SM4651	High-speed counter ring length (CH8)	OFF: Disabled ON: Enabled	○	○	R/W
SM4652	High-speed counter ring length (CH9)	OFF: Disabled ON: Enabled	×	○	R/W
SM4653	High-speed counter ring length (CH10)	OFF: Disabled ON: Enabled	×	○	R/W

No.	Name	Description	Function support		R/W
			FX5UJ	FX5U/ FX5UC	
SM4654	High-speed counter ring length (CH11)	OFF: Disabled ON: Enabled	×	○	R/W
SM4655	High-speed counter ring length (CH12)	OFF: Disabled ON: Enabled	×	○	R/W
SM4656	High-speed counter ring length (CH13)	OFF: Disabled ON: Enabled	×	○	R/W
SM4657	High-speed counter ring length (CH14)	OFF: Disabled ON: Enabled	×	○	R/W
SM4658	High-speed counter ring length (CH15)	OFF: Disabled ON: Enabled	×	○	R/W
SM4659	High-speed counter ring length (CH16)	OFF: Disabled ON: Enabled	×	○	R/W
SM4980	High-speed comparison table (high-speed compare instruction) operation (CPU module)	OFF: Stopped ON: Operation	○	○	R
SM4982	High-speed comparison table (high-speed compare instruction) error occurrence (CPU module)	OFF: No error ON: Error	○	○	R/W
SM4984	High-speed comparison table operation (high-speed pulse input/output module first module)	OFF: Stopped ON: Operation	×	○	R
SM4986	High-speed comparison table error occurrence (high-speed pulse input/output module first module)	OFF: No error ON: Error	×	○	R/W
SM4988	High-speed comparison table operation (high-speed pulse input/output module second module)	OFF: Stopped ON: Operation	×	○	R
SM4990	High-speed comparison table error occurrence (high-speed pulse input/output module second module)	OFF: No error ON: Error	×	○	R/W
SM4992	High-speed comparison table operation (high-speed pulse input/output module third module)	OFF: Stopped ON: Operation	×	○	R
SM4994	High-speed comparison table error occurrence (high-speed pulse input/output module third module)	OFF: No error ON: Error	×	○	R/W
SM4996	High-speed comparison table operation (high-speed pulse input/output module fourth module)	OFF: Stopped ON: Operation	×	○	R
SM4998	High-speed comparison table error occurrence (high-speed pulse input/output module fourth module)	OFF: No error ON: Error	×	○	R/W
SM5000	Multi-point output high-speed comparison table operation	OFF: Stopped ON: Operation	○	○	R
SM5001	Multi-point output high-speed comparison table completion	OFF: Not completed ON: Completion	○	○	R/W
SM5020	Pulse width measurement operation (CH1)	OFF: Stopped ON: Operation	○	○	R
SM5021	Pulse width measurement operation (CH2)	OFF: Stopped ON: Operation	○	○	R
SM5022	Pulse width measurement operation (CH3)	OFF: Stopped ON: Operation	○	○	R
SM5023	Pulse width measurement operation (CH4)	OFF: Stopped ON: Operation	○	○	R
SM5024	Pulse width measurement operation (CH5)	OFF: Stopped ON: Operation	×	○	R
SM5025	Pulse width measurement operation (CH6)	OFF: Stopped ON: Operation	×	○	R
SM5026	Pulse width measurement operation (CH7)	OFF: Stopped ON: Operation	×	○	R
SM5027	Pulse width measurement operation (CH8)	OFF: Stopped ON: Operation	×	○	R
SM5028	Pulse width measurement operation (CH9)	OFF: Stopped ON: Operation	×	○	R
SM5029	Pulse width measurement operation (CH10)	OFF: Stopped ON: Operation	×	○	R
SM5030	Pulse width measurement operation (CH11)	OFF: Stopped ON: Operation	×	○	R

No.	Name	Description	Function support		R/W
			FX5UJ	FX5U/ FX5UC	
SM5031	Pulse width measurement operation (CH12)	OFF: Stopped ON: Operation	×	○	R
SM5036	Pulse width measurement period measurement complete (CH1)	OFF: Cycle measurement not completed ON: Cycle measurement completion	○	○	R
SM5037	Pulse width measurement period measurement complete (CH2)	OFF: Cycle measurement not completed ON: Cycle measurement completion	○	○	R
SM5038	Pulse width measurement period measurement complete (CH3)	OFF: Cycle measurement not completed ON: Cycle measurement completion	○	○	R
SM5039	Pulse width measurement period measurement complete (CH4)	OFF: Cycle measurement not completed ON: Cycle measurement completion	○	○	R
SM5040	Pulse width measurement period measurement complete (CH5)	OFF: Cycle measurement not completed ON: Cycle measurement completion	×	○	R
SM5041	Pulse width measurement period measurement complete (CH6)	OFF: Cycle measurement not completed ON: Cycle measurement completion	×	○	R
SM5042	Pulse width measurement period measurement complete (CH7)	OFF: Cycle measurement not completed ON: Cycle measurement completion	×	○	R
SM5043	Pulse width measurement period measurement complete (CH8)	OFF: Cycle measurement not completed ON: Cycle measurement completion	×	○	R
SM5044	Pulse width measurement period measurement complete (CH9)	OFF: Cycle measurement not completed ON: Cycle measurement completion	×	○	R
SM5045	Pulse width measurement period measurement complete (CH10)	OFF: Cycle measurement not completed ON: Cycle measurement completion	×	○	R
SM5046	Pulse width measurement period measurement complete (CH11)	OFF: Cycle measurement not completed ON: Cycle measurement completion	×	○	R
SM5047	Pulse width measurement period measurement complete (CH12)	OFF: Cycle measurement not completed ON: Cycle measurement completion	×	○	R
SM5052	Pulse width measurement pulse width measurement complete (CH1)	OFF: Pulse width measurement not completed ON: Pulse width measurement completion	○	○	R
SM5053	Pulse width measurement pulse width measurement complete (CH2)	OFF: Pulse width measurement not completed ON: Pulse width measurement completion	○	○	R
SM5054	Pulse width measurement pulse width measurement complete (CH3)	OFF: Pulse width measurement not completed ON: Pulse width measurement completion	○	○	R
SM5055	Pulse width measurement pulse width measurement complete (CH4)	OFF: Pulse width measurement not completed ON: Pulse width measurement completion	○	○	R
SM5056	Pulse width measurement pulse width measurement complete (CH5)	OFF: Pulse width measurement not completed ON: Pulse width measurement completion	×	○	R
SM5057	Pulse width measurement pulse width measurement complete (CH6)	OFF: Pulse width measurement not completed ON: Pulse width measurement completion	×	○	R
SM5058	Pulse width measurement pulse width measurement complete (CH7)	OFF: Pulse width measurement not completed ON: Pulse width measurement completion	×	○	R
SM5059	Pulse width measurement pulse width measurement complete (CH8)	OFF: Pulse width measurement not completed ON: Pulse width measurement completion	×	○	R
SM5060	Pulse width measurement pulse width measurement complete (CH9)	OFF: Pulse width measurement not completed ON: Pulse width measurement completion	×	○	R
SM5061	Pulse width measurement pulse width measurement complete (CH10)	OFF: Pulse width measurement not completed ON: Pulse width measurement completion	×	○	R
SM5062	Pulse width measurement pulse width measurement complete (CH11)	OFF: Pulse width measurement not completed ON: Pulse width measurement completion	×	○	R
SM5063	Pulse width measurement pulse width measurement complete (CH12)	OFF: Pulse width measurement not completed ON: Pulse width measurement completion	×	○	R
SM5068	Pulse width measurement mode (CH1)	OFF: Always measurement mode ON: 1 time measurement mode	○	○	R/W
SM5069	Pulse width measurement mode (CH2)	OFF: Always measurement mode ON: 1 time measurement mode	○	○	R/W
SM5070	Pulse width measurement mode (CH3)	OFF: Always measurement mode ON: 1 time measurement mode	○	○	R/W
SM5071	Pulse width measurement mode (CH4)	OFF: Always measurement mode ON: 1 time measurement mode	○	○	R/W

No.	Name	Description	Function support		R/W
			FX5UJ	FX5U/ FX5UC	
SM5072	Pulse width measurement mode (CH5)	OFF: Always measurement mode ON: 1 time measurement mode	×	○	R/W
SM5073	Pulse width measurement mode (CH6)	OFF: Always measurement mode ON: 1 time measurement mode	×	○	R/W
SM5074	Pulse width measurement mode (CH7)	OFF: Always measurement mode ON: 1 time measurement mode	×	○	R/W
SM5075	Pulse width measurement mode (CH8)	OFF: Always measurement mode ON: 1 time measurement mode	×	○	R/W
SM5076	Pulse width measurement mode (CH9)	OFF: Always measurement mode ON: 1 time measurement mode	×	○	R/W
SM5077	Pulse width measurement mode (CH10)	OFF: Always measurement mode ON: 1 time measurement mode	×	○	R/W
SM5078	Pulse width measurement mode (CH11)	OFF: Always measurement mode ON: 1 time measurement mode	×	○	R/W
SM5079	Pulse width measurement mode (CH12)	OFF: Always measurement mode ON: 1 time measurement mode	×	○	R/W
SM5300	PWM function operation (CH1)	OFF: Stopped ON: Operation	○	○	R
SM5301	PWM function operation (CH2)	OFF: Stopped ON: Operation	○	○	R
SM5302	PWM function operation (CH3)	OFF: Stopped ON: Operation	○	○	R
SM5303	PWM function operation (CH4)	OFF: Stopped ON: Operation	○	○	R
SM5304	PWM function operation (CH5)	OFF: Stopped ON: Operation	×	○	R
SM5305	PWM function operation (CH6)	OFF: Stopped ON: Operation	×	○	R
SM5306	PWM function operation (CH7)	OFF: Stopped ON: Operation	×	○	R
SM5307	PWM function operation (CH8)	OFF: Stopped ON: Operation	×	○	R
SM5308	PWM function operation (CH9)	OFF: Stopped ON: Operation	×	○	R
SM5309	PWM function operation (CH10)	OFF: Stopped ON: Operation	×	○	R
SM5310	PWM function operation (CH11)	OFF: Stopped ON: Operation	×	○	R
SM5311	PWM function operation (CH12)	OFF: Stopped ON: Operation	×	○	R
SM5316	PWM output complete flag (CH1)	OFF: Other than normally end ON: Normally end	○	○	R/W
SM5317	PWM output complete flag (CH2)	OFF: Other than normally end ON: Normally end	○	○	R/W
SM5318	PWM output complete flag (CH3)	OFF: Other than normally end ON: Normally end	○	○	R/W
SM5319	PWM output complete flag (CH4)	OFF: Other than normally end ON: Normally end	○	○	R/W
SM5320	PWM output complete flag (CH5)	OFF: Other than normally end ON: Normally end	×	○	R/W
SM5321	PWM output complete flag (CH6)	OFF: Other than normally end ON: Normally end	×	○	R/W
SM5322	PWM output complete flag (CH7)	OFF: Other than normally end ON: Normally end	×	○	R/W
SM5323	PWM output complete flag (CH8)	OFF: Other than normally end ON: Normally end	×	○	R/W
SM5324	PWM output complete flag (CH9)	OFF: Other than normally end ON: Normally end	×	○	R/W

No.	Name	Description	Function support		R/W
			FX5UJ	FX5U/ FX5UC	
SM5325	PWM output complete flag (CH10)	OFF: Other than normally end ON: Normally end	×	○	R/W
SM5326	PWM output complete flag (CH11)	OFF: Other than normally end ON: Normally end	×	○	R/W
SM5327	PWM output complete flag (CH12)	OFF: Other than normally end ON: Normally end	×	○	R/W
SM5332	PWM output abnormal end flag (CH1)	OFF: No error ON: Abnormal end	○	○	R/W
SM5333	PWM output abnormal end flag (CH2)	OFF: No error ON: Abnormal end	○	○	R/W
SM5334	PWM output abnormal end flag (CH3)	OFF: No error ON: Abnormal end	○	○	R/W
SM5335	PWM output abnormal end flag (CH4)	OFF: No error ON: Abnormal end	○	○	R/W
SM5336	PWM output abnormal end flag (CH5)	OFF: No error ON: Abnormal end	×	○	R/W
SM5337	PWM output abnormal end flag (CH6)	OFF: No error ON: Abnormal end	×	○	R/W
SM5338	PWM output abnormal end flag (CH7)	OFF: No error ON: Abnormal end	×	○	R/W
SM5339	PWM output abnormal end flag (CH8)	OFF: No error ON: Abnormal end	×	○	R/W
SM5340	PWM output abnormal end flag (CH9)	OFF: No error ON: Abnormal end	×	○	R/W
SM5341	PWM output abnormal end flag (CH10)	OFF: No error ON: Abnormal end	×	○	R/W
SM5342	PWM output abnormal end flag (CH11)	OFF: No error ON: Abnormal end	×	○	R/W
SM5343	PWM output abnormal end flag (CH12)	OFF: No error ON: Abnormal end	×	○	R/W
SM5500	Positioning instruction activation (axis 1)	OFF: Stopped ON: Operation	○	○	R
SM5501	Positioning instruction activation (axis 2)	OFF: Stopped ON: Operation	○	○	R
SM5502	Positioning instruction activation (axis 3)	OFF: Stopped ON: Operation	○	○	R
SM5503	Positioning instruction activation (axis 4)	OFF: Stopped ON: Operation	×	○	R
SM5504	Positioning instruction activation (axis 5)	OFF: Stopped ON: Operation	×	○	R
SM5505	Positioning instruction activation (axis 6)	OFF: Stopped ON: Operation	×	○	R
SM5506	Positioning instruction activation (axis 7)	OFF: Stopped ON: Operation	×	○	R
SM5507	Positioning instruction activation (axis 8)	OFF: Stopped ON: Operation	×	○	R
SM5508	Positioning instruction activation (axis 9)	OFF: Stopped ON: Operation	×	○	R
SM5509	Positioning instruction activation (axis 10)	OFF: Stopped ON: Operation	×	○	R
SM5510	Positioning instruction activation (axis 11)	OFF: Stopped ON: Operation	×	○	R
SM5511	Positioning instruction activation (axis 12)	OFF: Stopped ON: Operation	×	○	R
SM5516	Positioning pulse output monitor (axis 1)	OFF: Stopped ON: Output	○	○	R
SM5517	Positioning pulse output monitor (axis 2)	OFF: Stopped ON: Output	○	○	R

No.	Name	Description	Function support		R/W
			FX5UJ	FX5U/ FX5UC	
SM5518	Positioning pulse output monitor (axis 3)	OFF: Stopped ON: Output	○	○	R
SM5519	Positioning pulse output monitor (axis 4)	OFF: Stopped ON: Output	×	○	R
SM5520	Positioning pulse output monitor (axis 5)	OFF: Stopped ON: Output	×	○	R
SM5521	Positioning pulse output monitor (axis 6)	OFF: Stopped ON: Output	×	○	R
SM5522	Positioning pulse output monitor (axis 7)	OFF: Stopped ON: Output	×	○	R
SM5523	Positioning pulse output monitor (axis 8)	OFF: Stopped ON: Output	×	○	R
SM5524	Positioning pulse output monitor (axis 9)	OFF: Stopped ON: Output	×	○	R
SM5525	Positioning pulse output monitor (axis 10)	OFF: Stopped ON: Output	×	○	R
SM5526	Positioning pulse output monitor (axis 11)	OFF: Stopped ON: Output	×	○	R
SM5527	Positioning pulse output monitor (axis 12)	OFF: Stopped ON: Output	×	○	R
SM5532	Positioning error (axis 1)	OFF: No error ON: Error	○	○	R/W
SM5533	Positioning error (axis 2)	OFF: No error ON: Error	○	○	R/W
SM5534	Positioning error (axis 3)	OFF: No error ON: Error	○	○	R/W
SM5535	Positioning error (axis 4)	OFF: No error ON: Error	×	○	R/W
SM5536	Positioning error (axis 5)	OFF: No error ON: Error	×	○	R/W
SM5537	Positioning error (axis 6)	OFF: No error ON: Error	×	○	R/W
SM5538	Positioning error (axis 7)	OFF: No error ON: Error	×	○	R/W
SM5539	Positioning error (axis 8)	OFF: No error ON: Error	×	○	R/W
SM5540	Positioning error (axis 9)	OFF: No error ON: Error	×	○	R/W
SM5541	Positioning error (axis 10)	OFF: No error ON: Error	×	○	R/W
SM5542	Positioning error (axis 11)	OFF: No error ON: Error	×	○	R/W
SM5543	Positioning error (axis 12)	OFF: No error ON: Error	×	○	R/W
SM5580	Positioning table shift instructions (axis 1)	OFF: No table shift ON: Table shift start	○	○	R/W
SM5581	Positioning table shift instructions (axis 2)	OFF: No table shift ON: Table shift start	○	○	R/W
SM5582	Positioning table shift instructions (axis 3)	OFF: No table shift ON: Table shift start	○	○	R/W
SM5583	Positioning table shift instructions (axis 4)	OFF: No table shift ON: Table shift start	×	○	R/W
SM5584	Positioning table shift instructions (axis 5)	OFF: No table shift ON: Table shift start	×	○	R/W
SM5585	Positioning table shift instructions (axis 6)	OFF: No table shift ON: Table shift start	×	○	R/W
SM5586	Positioning table shift instructions (axis 7)	OFF: No table shift ON: Table shift start	×	○	R/W

No.	Name	Description	Function support		R/W
			FX5UJ	FX5U/ FX5UC	
SM5628	Positioning pulse output stop command (axis 1)	OFF: Pulse output is not stopped ON: Pulse output immediate stop	○	○	R/W
SM5629	Positioning pulse output stop command (axis 2)	OFF: Pulse output is not stopped ON: Pulse output immediate stop	○	○	R/W
SM5630	Positioning pulse output stop command (axis 3)	OFF: Pulse output is not stopped ON: Pulse output immediate stop	○	○	R/W
SM5631	Positioning pulse output stop command (axis 4)	OFF: Pulse output is not stopped ON: Pulse output immediate stop	×	○	R/W
SM5632	Positioning pulse output stop command (axis 5)	OFF: Pulse output is not stopped ON: Pulse output immediate stop	×	○	R/W
SM5633	Positioning pulse output stop command (axis 6)	OFF: Pulse output is not stopped ON: Pulse output immediate stop	×	○	R/W
SM5634	Positioning pulse output stop command (axis 7)	OFF: Pulse output is not stopped ON: Pulse output immediate stop	×	○	R/W
SM5635	Positioning pulse output stop command (axis 8)	OFF: Pulse output is not stopped ON: Pulse output immediate stop	×	○	R/W
SM5636	Positioning pulse output stop command (axis 9)	OFF: Pulse output is not stopped ON: Pulse output immediate stop	×	○	R/W
SM5637	Positioning pulse output stop command (axis 10)	OFF: Pulse output is not stopped ON: Pulse output immediate stop	×	○	R/W
SM5638	Positioning pulse output stop command (axis 11)	OFF: Pulse output is not stopped ON: Pulse output immediate stop	×	○	R/W
SM5639	Positioning pulse output stop command (axis 12)	OFF: Pulse output is not stopped ON: Pulse output immediate stop	×	○	R/W
SM5644	Positioning pulse decelerates stop command (axis 1) (With remaining distance operation)	OFF: Pulse output is not stopped ON: Pulse output decelerates stop	○	○	R/W
SM5645	Positioning pulse decelerates stop command (axis 2) (With remaining distance operation)	OFF: Pulse output is not stopped ON: Pulse output decelerates stop	○	○	R/W
SM5646	Positioning pulse decelerates stop command (axis 3) (With remaining distance operation)	OFF: Pulse output is not stopped ON: Pulse output decelerates stop	○	○	R/W
SM5647	Positioning pulse decelerates stop command (axis 4) (With remaining distance operation)	OFF: Pulse output is not stopped ON: Pulse output decelerates stop	×	○	R/W
SM5648	Positioning pulse decelerates stop command (axis 5) (With remaining distance operation)	OFF: Pulse output is not stopped ON: Pulse output decelerates stop	×	○	R/W
SM5649	Positioning pulse decelerates stop command (axis 6) (With remaining distance operation)	OFF: Pulse output is not stopped ON: Pulse output decelerates stop	×	○	R/W
SM5650	Positioning pulse decelerates stop command (axis 7) (With remaining distance operation)	OFF: Pulse output is not stopped ON: Pulse output decelerates stop	×	○	R/W
SM5651	Positioning pulse decelerates stop command (axis 8) (With remaining distance operation)	OFF: Pulse output is not stopped ON: Pulse output decelerates stop	×	○	R/W
SM5652	Positioning pulse decelerates stop command (axis 9) (With remaining distance operation)	OFF: Pulse output is not stopped ON: Pulse output decelerates stop	×	○	R/W
SM5653	Positioning pulse decelerates stop command (axis 10) (With remaining distance operation)	OFF: Pulse output is not stopped ON: Pulse output decelerates stop	×	○	R/W
SM5654	Positioning pulse decelerates stop command (axis 11) (With remaining distance operation)	OFF: Pulse output is not stopped ON: Pulse output decelerates stop	×	○	R/W
SM5655	Positioning pulse decelerates stop command (axis 12) (With remaining distance operation)	OFF: Pulse output is not stopped ON: Pulse output decelerates stop	×	○	R/W
SM5660	Positioning forward rotation limit (axis 1)	OFF: Forward rotation limit OFF ON: Forward rotation limit ON	○	○	R/W
SM5661	Positioning forward rotation limit (axis 2)	OFF: Forward rotation limit OFF ON: Forward rotation limit ON	○	○	R/W
SM5662	Positioning forward rotation limit (axis 3)	OFF: Forward rotation limit OFF ON: Forward rotation limit ON	○	○	R/W
SM5663	Positioning forward rotation limit (axis 4)	OFF: Forward rotation limit OFF ON: Forward rotation limit ON	×	○	R/W
SM5664	Positioning forward rotation limit (axis 5)	OFF: Forward rotation limit OFF ON: Forward rotation limit ON	×	○	R/W

No.	Name	Description	Function support		R/W
			FX5UJ	FX5U/ FX5UC	
SM5665	Positioning forward rotation limit (axis 6)	OFF: Forward rotation limit OFF ON: Forward rotation limit ON	×	○	R/W
SM5666	Positioning forward rotation limit (axis 7)	OFF: Forward rotation limit OFF ON: Forward rotation limit ON	×	○	R/W
SM5667	Positioning forward rotation limit (axis 8)	OFF: Forward rotation limit OFF ON: Forward rotation limit ON	×	○	R/W
SM5668	Positioning forward rotation limit (axis 9)	OFF: Forward rotation limit OFF ON: Forward rotation limit ON	×	○	R/W
SM5669	Positioning forward rotation limit (axis 10)	OFF: Forward rotation limit OFF ON: Forward rotation limit ON	×	○	R/W
SM5670	Positioning forward rotation limit (axis 11)	OFF: Forward rotation limit OFF ON: Forward rotation limit ON	×	○	R/W
SM5671	Positioning forward rotation limit (axis 12)	OFF: Forward rotation limit OFF ON: Forward rotation limit ON	×	○	R/W
SM5676	Positioning reverse rotation limit (axis 1)	OFF: Reverse rotation limit OFF ON: Reverse rotation limit ON	○	○	R/W
SM5677	Positioning reverse rotation limit (axis 2)	OFF: Reverse rotation limit OFF ON: Reverse rotation limit ON	○	○	R/W
SM5678	Positioning reverse rotation limit (axis 3)	OFF: Reverse rotation limit OFF ON: Reverse rotation limit ON	○	○	R/W
SM5679	Positioning reverse rotation limit (axis 4)	OFF: Reverse rotation limit OFF ON: Reverse rotation limit ON	×	○	R/W
SM5680	Positioning reverse rotation limit (axis 5)	OFF: Reverse rotation limit OFF ON: Reverse rotation limit ON	×	○	R/W
SM5681	Positioning reverse rotation limit (axis 6)	OFF: Reverse rotation limit OFF ON: Reverse rotation limit ON	×	○	R/W
SM5682	Positioning reverse rotation limit (axis 7)	OFF: Reverse rotation limit OFF ON: Reverse rotation limit ON	×	○	R/W
SM5683	Positioning reverse rotation limit (axis 8)	OFF: Reverse rotation limit OFF ON: Reverse rotation limit ON	×	○	R/W
SM5684	Positioning reverse rotation limit (axis 9)	OFF: Reverse rotation limit OFF ON: Reverse rotation limit ON	×	○	R/W
SM5685	Positioning reverse rotation limit (axis 10)	OFF: Reverse rotation limit OFF ON: Reverse rotation limit ON	×	○	R/W
SM5686	Positioning reverse rotation limit (axis 11)	OFF: Reverse rotation limit OFF ON: Reverse rotation limit ON	×	○	R/W
SM5687	Positioning reverse rotation limit (axis 12)	OFF: Reverse rotation limit OFF ON: Reverse rotation limit ON	×	○	R/W
SM5772	Positioning rotational direction (axis 1)	OFF: Forward rotation (Current address increases) ON: Reverse rotation (Current address increases)	○	○	R/W
SM5773	Positioning rotational direction (axis 2)	OFF: Forward rotation (Current address increases) ON: Reverse rotation (Current address increases)	○	○	R/W
SM5774	Positioning rotational direction (axis 3)	OFF: Forward rotation (Current address increases) ON: Reverse rotation (Current address increases)	○	○	R/W
SM5775	Positioning rotational direction (axis 4)	OFF: Forward rotation (Current address increases) ON: Reverse rotation (Current address increases)	×	○	R/W
SM5776	Positioning rotational direction (axis 5)	OFF: Forward rotation (Current address increases) ON: Reverse rotation (Current address increases)	×	○	R/W
SM5777	Positioning rotational direction (axis 6)	OFF: Forward rotation (Current address increases) ON: Reverse rotation (Current address increases)	×	○	R/W
SM5778	Positioning rotational direction (axis 7)	OFF: Forward rotation (Current address increases) ON: Reverse rotation (Current address increases)	×	○	R/W
SM5779	Positioning rotational direction (axis 8)	OFF: Forward rotation (Current address increases) ON: Reverse rotation (Current address increases)	×	○	R/W
SM5780	Positioning rotational direction (axis 9)	OFF: Forward rotation (Current address increases) ON: Reverse rotation (Current address increases)	×	○	R/W
SM5781	Positioning rotational direction (axis 10)	OFF: Forward rotation (Current address increases) ON: Reverse rotation (Current address increases)	×	○	R/W

No.	Name	Description	Function support		R/W
			FX5UJ	FX5U/ FX5UC	
SM5782	Positioning rotational direction (axis 11)	OFF: Forward rotation (Current address increases) ON: Reverse rotation (Current address increases)	×	○	R/W
SM5783	Positioning rotational direction (axis 12)	OFF: Forward rotation (Current address increases) ON: Reverse rotation (Current address increases)	×	○	R/W
SM5804	Positioning zero return direction (axis 1)	OFF: Zero return start (Reverse rotation direction) ON: Zero return start (Forward rotation direction)	○	○	R/W
SM5805	Positioning zero return direction (axis 2)	OFF: Zero return start (Reverse rotation direction) ON: Zero return start (Forward rotation direction)	○	○	R/W
SM5806	Positioning zero return direction (axis 3)	OFF: Zero return start (Reverse rotation direction) ON: Zero return start (Forward rotation direction)	○	○	R/W
SM5807	Positioning zero return direction (axis 4)	OFF: Zero return start (Reverse rotation direction) ON: Zero return start (Forward rotation direction)	×	○	R/W
SM5808	Positioning zero return direction (axis 5)	OFF: Zero return start (Reverse rotation direction) ON: Zero return start (Forward rotation direction)	×	○	R/W
SM5809	Positioning zero return direction (axis 6)	OFF: Zero return start (Reverse rotation direction) ON: Zero return start (Forward rotation direction)	×	○	R/W
SM5810	Positioning zero return direction (axis 7)	OFF: Zero return start (Reverse rotation direction) ON: Zero return start (Forward rotation direction)	×	○	R/W
SM5811	Positioning zero return direction (axis 8)	OFF: Zero return start (Reverse rotation direction) ON: Zero return start (Forward rotation direction)	×	○	R/W
SM5812	Positioning zero return direction (axis 9)	OFF: Zero return start (Reverse rotation direction) ON: Zero return start (Forward rotation direction)	×	○	R/W
SM5813	Positioning zero return direction (axis 10)	OFF: Zero return start (Reverse rotation direction) ON: Zero return start (Forward rotation direction)	×	○	R/W
SM5814	Positioning zero return direction (axis 11)	OFF: Zero return start (Reverse rotation direction) ON: Zero return start (Forward rotation direction)	×	○	R/W
SM5815	Positioning zero return direction (axis 12)	OFF: Zero return start (Reverse rotation direction) ON: Zero return start (Forward rotation direction)	×	○	R/W
SM5820	Positioning clear signal function (axis 1)	OFF: Clear signal disabled ON: Clear signal enabled	○	○	R/W
SM5821	Positioning clear signal function (axis 2)	OFF: Clear signal disabled ON: Clear signal enabled	○	○	R/W
SM5822	Positioning clear signal function (axis 3)	OFF: Clear signal disabled ON: Clear signal enabled	○	○	R/W
SM5823	Positioning clear signal function (axis 4)	OFF: Clear signal disabled ON: Clear signal enabled	×	○	R/W
SM5824	Positioning clear signal function (axis 5)	OFF: Clear signal disabled ON: Clear signal enabled	×	○	R/W
SM5825	Positioning clear signal function (axis 6)	OFF: Clear signal disabled ON: Clear signal enabled	×	○	R/W
SM5826	Positioning clear signal function (axis 7)	OFF: Clear signal disabled ON: Clear signal enabled	×	○	R/W
SM5827	Positioning clear signal function (axis 8)	OFF: Clear signal disabled ON: Clear signal enabled	×	○	R/W
SM5828	Positioning clear signal function (axis 9)	OFF: Clear signal disabled ON: Clear signal enabled	×	○	R/W
SM5829	Positioning clear signal function (axis 10)	OFF: Clear signal disabled ON: Clear signal enabled	×	○	R/W
SM5830	Positioning clear signal function (axis 11)	OFF: Clear signal disabled ON: Clear signal enabled	×	○	R/W
SM5831	Positioning clear signal function (axis 12)	OFF: Clear signal disabled ON: Clear signal enabled	×	○	R/W
SM5868	Positioning zero-point signal count start (axis 1)	OFF: Near point DOG backward end ON: Near point DOG forward end	○	○	R/W
SM5869	Positioning zero-point signal count start (axis 2)	OFF: Near point DOG backward end ON: Near point DOG forward end	○	○	R/W
SM5870	Positioning zero-point signal count start (axis 3)	OFF: Near point DOG backward end ON: Near point DOG forward end	○	○	R/W

No.	Name	Description	Function support		R/W
			FX5UJ	FX5U/ FX5UC	
SM5871	Positioning zero-point signal count start (axis 4)	OFF: Near point DOG backward end ON: Near point DOG forward end	×	○	R/W
SM5872	Positioning zero-point signal count start (axis 5)	OFF: Near point DOG backward end ON: Near point DOG forward end	×	○	R/W
SM5873	Positioning zero-point signal count start (axis 6)	OFF: Near point DOG backward end ON: Near point DOG forward end	×	○	R/W
SM5874	Positioning zero-point signal count start (axis 7)	OFF: Near point DOG backward end ON: Near point DOG forward end	×	○	R/W
SM5875	Positioning zero-point signal count start (axis 8)	OFF: Near point DOG backward end ON: Near point DOG forward end	×	○	R/W
SM5876	Positioning zero-point signal count start (axis 9)	OFF: Near point DOG backward end ON: Near point DOG forward end	×	○	R/W
SM5877	Positioning zero-point signal count start (axis 10)	OFF: Near point DOG backward end ON: Near point DOG forward end	×	○	R/W
SM5878	Positioning zero-point signal count start (axis 11)	OFF: Near point DOG backward end ON: Near point DOG forward end	×	○	R/W
SM5879	Positioning zero-point signal count start (axis 12)	OFF: Near point DOG backward end ON: Near point DOG forward end	×	○	R/W
SM5916	Positioning axis 1 positioning table data initialization disable	OFF: Disabled ON: Enabled	○	○	R/W
SM5917	Positioning axis 2 positioning table data initialization disable	OFF: Disabled ON: Enabled	○	○	R/W
SM5918	Positioning axis 3 positioning table data initialization disable	OFF: Disabled ON: Enabled	○	○	R/W
SM5919	Positioning axis 4 positioning table data initialization disable	OFF: Disabled ON: Enabled	×	○	R/W
SM5920	Positioning axis 5 positioning table data initialization disable	OFF: Disabled ON: Enabled	×	○	R/W
SM5921	Positioning axis 6 positioning table data initialization disable	OFF: Disabled ON: Enabled	×	○	R/W
SM5922	Positioning axis 7 positioning table data initialization disable	OFF: Disabled ON: Enabled	×	○	R/W
SM5923	Positioning axis 8 positioning table data initialization disable	OFF: Disabled ON: Enabled	×	○	R/W
SM5924	Positioning axis 9 positioning table data initialization disable	OFF: Disabled ON: Enabled	×	○	R/W
SM5925	Positioning axis 10 positioning table data initialization disable	OFF: Disabled ON: Enabled	×	○	R/W
SM5926	Positioning axis 11 positioning table data initialization disable	OFF: Disabled ON: Enabled	×	○	R/W
SM5927	Positioning axis 12 positioning table data initialization disable	OFF: Disabled ON: Enabled	×	○	R/W

Built-in analog

The special relays for built-in analog are shown below.

○: Supported, ×: Not supported

R: Read only, R/W: Read/Write

No.	Name	Description	Function support		R/W
			FX5UJ	FX5U/ FX5UC*1	
SM6020	CH1 A/D conversion completed flag	OFF: A/D conversion not completed ON: A/D conversion completed	×	○	R
SM6021	CH1 A/D conversion enable/disable setting	OFF: A/D conversion enable ON: A/D conversion disable	×	○	R/W
SM6022	CH1 Over scaling upper limit detection flag	OFF: No over scaling ON: Over Scaling	×	○	R
SM6023	CH1 Over scaling lower limit detection flag	OFF: No over scaling ON: Over Scaling	×	○	R
SM6024	CH1 Over scaling over detection setting	OFF: Enable ON: Disable	×	○	R/W
SM6025	CH1 Maximum value/minimum value reset completed flag	OFF: Reset not completed ON: Reset completed	×	○	R
SM6026	CH1 Maximum value reset request	OFF: No reset request ON: Reset request	×	○	R/W
SM6027	CH1 Minimum value reset request	OFF: No reset request ON: Reset request	×	○	R/W
SM6028	CH1 A/D scaling enable/disable setting	OFF: Enable ON: Disable	×	○	R/W
SM6029	CH1 Digital clipping enable/disable setting	OFF: Enable ON: Disable	×	○	R/W
SM6031	CH1 Warning output flag (Process alarm upper limit)	OFF: No alarm ON: Alarm	×	○	R
SM6032	CH1 Warning output flag (Process alarm lower limit)	OFF: No alarm ON: Alarm	×	○	R
SM6033	CH1 Warning output setting (Process alarm)	OFF: Enabled ON: Disabled	×	○	R/W
SM6057	CH1 A/D alarm clear request	OFF: No clear request ON: Clear request	×	○	R/W
SM6058	CH1 A/D alarm flag	OFF: No alarm ON: Alarm	×	○	R
SM6059	CH1 A/D error flag	OFF: No error ON: Error	×	○	R
SM6060	CH2 A/D conversion completed flag	OFF: A/D conversion not completed ON: A/D conversion completed	×	○	R
SM6061	CH2 A/D conversion enable/disable setting	OFF: A/D conversion enable ON: A/D conversion disable	×	○	R/W
SM6062	CH2 Over scaling upper limit detection flag	OFF: No over scaling ON: Over scaling	×	○	R
SM6063	CH2 Over scaling lower limit detection flag	OFF: No over scaling ON: Over scaling	×	○	R
SM6064	CH2 Over scaling over detection	OFF: Enable ON: Disable	×	○	R/W
SM6065	CH2 Maximum value/minimum value reset completed flag	OFF: Reset not completed ON: Reset completed	×	○	R
SM6066	CH2 Maximum value reset request	OFF: No reset request ON: Reset request	×	○	R/W
SM6067	CH2 Minimum value reset request	OFF: No reset request ON: Reset request	×	○	R/W
SM6068	CH2 A/D scaling enable/disable setting	OFF: Enable ON: Disable	×	○	R/W
SM6069	CH2 Digital clipping enable/disable setting	OFF: Enable ON: Disable	×	○	R/W

No.	Name	Description	Function support		R/W
			FX5UJ	FX5U/ FX5UC*1	
SM6071	CH2 Warning output flag (Process alarm upper limit)	OFF: No alarm ON: Alarm	×	○	R
SM6072	CH2 Warning output flag (Process alarm lower limit)	OFF: No alarm ON: Alarm	×	○	R
SM6073	CH2 Warning output setting (Process alarm)	OFF: Enabled ON: Disabled	×	○	R/W
SM6097	CH2 A/D alarm clear request	OFF: No clear request ON: Clear request	×	○	R/W
SM6098	CH2 A/D alarm flag	OFF: No alarm ON: Alarm	×	○	R/W
SM6099	CH2 A/D error flag	OFF: No error ON: Error	×	○	R/W
SM6180	D/A conversion enable/disable setting	OFF: D/A conversion enable ON: D/A conversion disable	×	○	R/W
SM6181	D/A output enable/disable	OFF: Output enable ON: Output disable	×	○	R/W
SM6188	Scaling enable/disable setting	OFF: Enable ON: Disable	×	○	R/W
SM6191	Warning output upper limit value flag	OFF: No alarm ON: Alarm	×	○	R
SM6192	Warning output lower limit value flag	OFF: No alarm ON: Alarm	×	○	R
SM6193	Warning output setting	OFF: Disabled ON: Enabled	×	○	R/W
SM6217	D/A alarm clear request	OFF: No clear request ON: Clear request	×	○	R/W
SM6218	D/A alarm flag	OFF: No alarm ON: Alarm	×	○	R
SM6219	D/A error flag	OFF: No error ON: Error	×	○	R

*1 Only FX5U CPU module is supported.

FX compatible area

The special relays of FX compatible area are shown below.

○: Supported, ×: Not supported

R: Read only, R/W: Read/Write

No.	Name	Description	Function support		R/W
			FX5UJ	FX5U/ FX5UC	
SM8000	RUN monitor NO contact	OFF: STOP ON: RUN	○	○	R
SM8001	RUN monitor NC contact	OFF: RUN ON: STOP	○	○	R
SM8002	Initial pulse NO contact	OFF: SM8002 turns off except during 1 scan at the time of RUN ON: SM8002 turns on during 1 scan at the time of RUN	○	○	R
SM8003	Initial pulse NC contact	OFF: SM8003 turns on during 1 scan at the time of RUN ON: SM8003 turns off except during 1 scan at the time of RUN	○	○	R
SM8004	Error occurrence	OFF: No error ON: Error	○	○	R
SM8005	Battery voltage low	OFF: Battery normal ON: Battery voltage low	×	○	R
SM8006	Battery error latch	OFF: Battery normal ON: Battery voltage low latch	×	○	R
SM8007	Momentary power failure	OFF: No momentary power failure ON: Momentary power failure detected	○	○	R
SM8008	Power failure detected	OFF: No momentary power failure ON: During momentary power failure	○	○	R
SM8011	10 msec clock pulse	ON and OFF in 10 ms cycles OFF: 5 ms ON: 5 ms	○	○	R
SM8012	100 msec clock pulse	ON and OFF in 100 ms cycles OFF: 50 ms ON: 50 ms	○	○	R
SM8013	1 sec clock pulse	ON and OFF in 1 sec cycles OFF: 500 ms ON: 500 ms	○	○	R
SM8014	1 min clock pulse	ON and OFF in 1 min cycles OFF: 30 s ON: 30 s	○	○	R
SM8015	Clock stop and preset	When SM8015 turns ON, the real time clock is stopped. At the edge from ON to OFF, the time from SD8013 to SD8019 is written to the PLC and the clock is started again.	○	○	R/W
SM8016	Time read display is stopped	When SM8016 turns ON, the time display is stopped.	○	○	R/W
SM8017	±30 seconds correction	At the edge from OFF to ON, the RTC is set to the nearest minute. (When the second data is from 0 to 29, it is set to 0. When the second data is from 30 to 59, it is set to 0 and the minute data is incremented by "1".)	○	○	R/W
SM8019	Real time clock error	When the data stored in special registers is outside the allowable time setting range, this device turns ON.	○	○	R
SM8020	Zero	OFF: Zero flag OFF ON: Zero flag ON	○	○	R
SM8021	Borrow	OFF: Borrow flag OFF ON: Borrow flag ON	○	○	R
SM8022	Carry	OFF: Carry flag OFF ON: Carry flag ON	○	○	R

A

No.	Name	Description	Function support		R/W
			FX5UJ	FX5U/ FX5UC	
SM8023	Real time clock access error	SM8023 turns ON at the time of RTC access (reading/writing) error occurrence.	○	○	R
SM8026	RAMP mode	OFF: Standard mode ON: RAMP mode	○	○	R/W
SM8029	Instruction execution complete	OFF: Instruction execution not complete ON: Instruction execution complete	○	○	R
SM8031	Non-latch memory all clear	OFF: No clear ON: Non-latch memory all clear	○	○	R/W
SM8032	Latch memory all clear	OFF: No clear ON: Latch memory all clear	○	○	R/W
SM8033	Memory hold stop	OFF: Clear ON: Hold	○	○	R/W
SM8034	All output disable	OFF: Normal operation ON: All output disable	○	○	R/W
SM8039	Constant scan mode	OFF: Normal operation ON: Constant scan mode	○	○	R/W
SM8040	STL transfer disable	OFF: Normal operation ON: Transfer disable	○	○	R/W
SM8041	Transfer start	Transfer from initial state is enabled in automatic operation mode	○	○	R
SM8042	Start pulse	Pulse output is given in response to a start input	○	○	R
SM8043	Zero return complete	Set this in the last state of zero return mode	○	○	R/W
SM8044	Zero point condition	Set this when machine zero return is detected	○	○	R/W
SM8045	All output reset disable	Disables the 'all output reset' function when the operation mode is changed	○	○	R/W
SM8046*1	STL state ON	ON when SM8047 is ON and any state (S) is active	○	○	R
SM8047*1	Enable STL monitoring	SD8040 to SD8047 are enabled when SM8047 is ON	○	○	R/W
SM8048	Annunciator ON	ON when SM8049 is ON and any annunciator (F) is ON.	○	○	R
SM8049	Enable annunciator monitoring	SD8049 is enabled when SM8049 is ON.	○	○	R/W
SM8050	I0 interrupt disabled (Input interrupt)	OFF: Interrupt enabled ON: Interrupt disabled	○	○	R/W
SM8051	I1 interrupt disabled (Input interrupt)	OFF: Interrupt enabled ON: Interrupt disabled	○	○	R/W
SM8052	I2 interrupt disabled (Input interrupt)	OFF: Interrupt enabled ON: Interrupt disabled	○	○	R/W
SM8053	I3 interrupt disabled (Input interrupt)	OFF: Interrupt enabled ON: Interrupt disabled	○	○	R/W
SM8054	I4 interrupt disabled (Input interrupt)	OFF: Interrupt enabled ON: Interrupt disabled	○	○	R/W
SM8055	I5 interrupt disabled (Input interrupt)	OFF: Interrupt enabled ON: Interrupt disabled	○	○	R/W
SM8056	I28 interrupt disabled (Interrupt from internal timer)	OFF: Interrupt enabled ON: Interrupt disabled	○	○	R/W
SM8057	I29 interrupt disabled (Interrupt from internal timer)	OFF: Interrupt enabled ON: Interrupt disabled	○	○	R/W
SM8058	I30 interrupt disabled (Interrupt from internal timer)	OFF: Interrupt enabled ON: Interrupt disabled	○	○	R/W
SM8059	I16 to I23 interrupt disabled (High-speed comparison match interrupt)	OFF: Interrupt enabled ON: Interrupt disabled	○	○	R/W
SM8063	Serial communication error1 (CH1)	OFF: No error ON: Error	○	○	R
SM8067	Operation error	OFF: No error ON: Error	○	○	R
SM8068	Operation error latch	OFF: No error ON: Error (latch)	○	○	R

No.	Name	Description	Function support		R/W
			FX5UJ	FX5U/ FX5UC	
SM8072	Parallel link operation	OFF: In stopped state ON: In normal running state	○	○	R
SM8090	Block comparison signal	Block comparison signal ON when all comparison results are ON.	○	○	R
SM8099	High-speed ring counter	OFF: High-speed ring counter stop ON: High-speed ring counter start	○	○	R/W
SM8125	Setting of computer link model code	ON: Low order 8 bits of SD8126 are used as a model name. OFF: F3H (fixed value) is used as a model name.	○	○	R/W
SM8126	Global ON (CH1)	Turns ON when the global command is received.	○	○	R
SM8151	Inverter communication (CH1)	ON during inverter communication.	○	○	R
SM8152	Inverter communication error (CH1)	OFF: No error ON: Error	○	○	R
SM8153	Inverter communication error latch (CH1)	OFF: No error ON: Error (latch)	○	○	R
SM8154	IVBWR instruction error (CH1)	OFF: No error ON: Error	○	○	R
SM8156	Inverter communication (CH2)	ON during inverter communication.	○	○	R
SM8157	Inverter communication error (CH2)	OFF: No error ON: Error	○	○	R
SM8158	Inverter communication error latch (CH2)	OFF: No error ON: Error (latch)	○	○	R
SM8159	IVBWR instruction error (CH2)	OFF: No error ON: Error	○	○	R
SM8161	8 bit operation mode	OFF: 16 bit operation mode ON: 8 bit operation mode	○	○	R/W
SM8168	SMOV data mode	BIN→BCD conversion will not be performed, if a SMOV instruction is executed after turning on SM8168.	○	○	R/W
SM8170	X0 pulse catch	Pulse catch ON when X0 is OFF→ON	○	○	R/W
SM8171	X1 pulse catch	Pulse catch ON when X1 is OFF→ON	○	○	R/W
SM8172	X2 pulse catch	Pulse catch ON when X2 is OFF→ON	○	○	R/W
SM8173	X3 pulse catch	Pulse catch ON when X3 is OFF→ON	○	○	R/W
SM8174	X4 pulse catch	Pulse catch ON when X4 is OFF→ON	○	○	R/W
SM8175	X5 pulse catch	Pulse catch ON when X5 is OFF→ON.	○	○	R/W
SM8176	X6 pulse catch	Pulse catch ON when X6 is OFF→ON.	○	○	R/W
SM8177	X7 pulse catch	Pulse catch ON when X7 is OFF→ON.	○	○	R/W
SM8183	Data communication error (Master station)	OFF: No error ON: Error	○	○	R
SM8184	Data communication error (Slave station No.1)	OFF: No error ON: Error	○	○	R
SM8185	Data communication error (Slave station No.2)	OFF: No error ON: Error	○	○	R
SM8186	Data communication error (Slave station No.3)	OFF: No error ON: Error	○	○	R
SM8187	Data communication error (Slave station No.4)	OFF: No error ON: Error	○	○	R
SM8188	Data communication error (Slave station No.5)	OFF: No error ON: Error	○	○	R
SM8189	Data communication error (Slave station No.6)	OFF: No error ON: Error	○	○	R
SM8190	Data communication error (Slave station No.7)	OFF: No error ON: Error	○	○	R
SM8191	Data communication in execution	OFF: Data communication in execution ON: Data communication in nonexecution	○	○	R
SM8200	LC0 counting direction specification	OFF: Up-counting specification ON: Down-counting specification	○	○	R/W

No.	Name	Description	Function support		R/W
			FX5UJ	FX5U/ FX5UC	
SM8230	LC30 counting direction specification	OFF: Up-counting specification ON: Down-counting specification	○	○	R/W
SM8231	LC31 counting direction specification	OFF: Up-counting specification ON: Down-counting specification	○	○	R/W
SM8232	LC32 counting direction specification	OFF: Up-counting specification ON: Down-counting specification	○	○	R/W
SM8233	LC33 counting direction specification	OFF: Up-counting specification ON: Down-counting specification	○	○	R/W
SM8234	LC34 counting direction specification	OFF: Up-counting specification ON: Down-counting specification	○	○	R/W
SM8246	LC46 counting direction monitoring	OFF: Down count operation ON: Up count operation	○	○	R
SM8247	LC47 counting direction monitoring	OFF: Down count operation ON: Up count operation	○	○	R
SM8248	LC48 counting direction monitoring	OFF: Down count operation ON: Up count operation	○	○	R
SM8249	LC49 counting direction monitoring	OFF: Down count operation ON: Up count operation	○	○	R
SM8250	LC50 counting direction monitoring	OFF: Down count operation ON: Up count operation	○	○	R
SM8251	LC51 counting direction monitoring	OFF: Down count operation ON: Up count operation	○	○	R
SM8252	LC52 counting direction monitoring	OFF: Down count operation ON: Up count operation	○	○	R
SM8253	LC53 counting direction monitoring	OFF: Down count operation ON: Up count operation	○	○	R
SM8254	LC54 counting direction monitoring	OFF: Down count operation ON: Up count operation	○	○	R
SM8255	LC55 counting direction monitoring	OFF: Down count operation ON: Up count operation	○	○	R
SM8304	Zero (MUL, DIV instructions only)	OFF: Zero flag OFF ON: Zero flag ON	○	○	R
SM8306	Carry (MUL, DIV instructions only)	OFF: Carry flag OFF ON: Carry flag ON	○	○	R
SM8312	RTC clock data loss error	ON when the RTC clock data loss error is occurred.	○	○	R
SM8328	Instruction non-execution	Turns ON when the RBFM instruction or WBFM instruction in another step is executed for the same module number.	×	○	R/W
SM8329	Instruction execution error	OFF: Instruction execution normal ON: Instruction execution error complete	○	○	R
SM8330	Timing clock output 1	DUTY instruction: Timing clock output 1	○	○	R
SM8331	Timing clock output 2	DUTY instruction: Timing clock output 2	○	○	R
SM8332	Timing clock output 3	DUTY instruction: Timing clock output 3	○	○	R
SM8333	Timing clock output 4	DUTY instruction: Timing clock output 4	○	○	R
SM8334	Timing clock output 5	DUTY instruction: Timing clock output 5	○	○	R
SM8340	Axis 1 pulse output monitor	OFF: Stopped ON: Pulse output	○	○	R
SM8348	Axis 1 positioning instruction executing	OFF: Positioning instruction not executing ON: Positioning instruction executing	○	○	R
SM8350	Axis 2 pulse output monitor	OFF: Stopped ON: Output	○	○	R
SM8358	Axis 2 positioning instruction executing	OFF: Positioning instruction not executing ON: Positioning instruction executing	○	○	R
SM8360	Axis 3 pulse output monitor	OFF: Stopped ON: Output	○	○	R
SM8368	Axis 3 positioning instruction executing	OFF: Positioning instruction not executing ON: Positioning instruction executing	○	○	R

No.	Name	Description	Function support		R/W
			FX5UJ	FX5U/ FX5UC	
SM8370	Axis 4 pulse output monitor	OFF: Stopped ON: Output	×	○	R
SM8378	Axis 4 positioning instruction executing	OFF: Positioning instruction not executing ON: Positioning instruction executing	×	○	R
SM8401	RS2 Send wait flag (CH1)/MODBUS request in process (CH1)	ON during send wait or MODBUS communication.	○	○	R
SM8402	MODBUS communication error (CH1)	OFF: No error ON: Error	○	○	R
SM8403	MODBUS communication error (latched) (CH1)	OFF: No error ON: Error (latch)	○	○	R
SM8404	RS2 Carrier detection flag (CH1)/MODBUS communication mode (CH1)	ON when carrier detection or listen only mode	○	○	R
SM8405	RS2 Data set ready (DSR) flag (CH1)	OFF: DSR not detected ON: DSR detected	○	○	R
SM8408	MODBUS retry (CH1)	OFF: Not retry ON: Retry	○	○	R
SM8409	RS2 Time-out check flag (CH1)/MODBUS Timeout (CH1)	ON when time-out occurs.	○	○	R
SM8419	Absence/presence of MC protocol (CH1)	Turns ON when MC protocol is set for serial communication.	○	○	R
SM8421	RS2 Send wait flag (CH2)/MODBUS request in process (CH2)	ON during send wait or MODBUS communication	○	○	R
SM8422	MODBUS communication error (CH2)	OFF: No error ON: Error	○	○	R
SM8423	MODBUS communication error (latched) (CH2)	OFF: No error ON: Error (latch)	○	○	R
SM8424	RS2 Carrier detection flag (CH2)/MODBUS communication mode (CH2)	Carrier detection flag or listen only mode ON when operating.	○	○	R
SM8425	RS2 Data set ready (DSR) flag (CH2)	OFF: DSR not detected ON: DSR detected	○	○	R
SM8426	Global ON (CH2)	Turns ON when the global command is received.	○	○	R
SM8428	MODBUS retry (CH2)	OFF: No retry ON: Retry	○	○	R
SM8429	RS2 Time-out check flag (CH2)/MODBUS Timeout (CH2)	ON when timeout occurs.	○	○	R
SM8438	Serial communication error 2 (CH2)	OFF: No error ON: Error	○	○	R
SM8439	Absence/presence of MC protocol (CH2)	Turns ON when MC protocol is set for serial communication.	○	○	R
SM8492	IP address storage area write request	If OFF to ON, the IP address setting stored in SD8492 to SD8497 will be written in the IP address storage area.	○	○	R/W
SM8493	IP address storage area write completed	<ul style="list-style-type: none"> • It turns on, if the write to the IP address storage area is completed. Moreover, it turns on also at the time of the write-in failure. • Turns OFF when IP address storage area write request (SM8492) turns from ON to OFF. 	○	○	R
SM8494	IP address storage area write error	<ul style="list-style-type: none"> • Turns ON when writing to IP address storage area is failed. • Turns ON if there is a problem in contents of IP address storage area, when PLC power supply is turned from OFF to ON. • Turns OFF when IP address storage area write request (SM8492) turns from ON to OFF. 	○	○	R
SM8495	IP address storage area clear request	Contents of IP address storage area are cleared when this device turns from OFF to ON.	○	○	R/W
SM8496	IP address storage area clear completed	<ul style="list-style-type: none"> • It turns on, if the clear to the IP address storage area is completed. Moreover, it turns on also at the time of the clear-in failure. • Turns OFF when IP address storage area clear request (SM8495) turns from ON to OFF. 	○	○	R

No.	Name	Description	Function support		R/W
			FX5UJ	FX5U/ FX5UC	
SM8497	IP address storage area clear error	<ul style="list-style-type: none"> Turns ON when clear to IP address storage area is failed. Turns OFF when IP address storage area clear request (SM8495) turns from ON to OFF. 	○	○	R
SM8498	IP address change function enable flag	Turns ON when IP address is changed by IP address change function.	○	○	R

*1 Enabled only when the STL instruction is used.

Serial communication

The special relays for serial communication are shown below.

○: Supported, ×: Not supported

R: Read only, R/W: Read/Write

No.	Name	Description	Function support		R/W
			FX5UJ	FX5U/ FX5UC*1	
SM8500	Serial communication error (CH1)	OFF: No error ON: Error	×	○	R
SM8503	Absence/presence of MC protocol (CH1)	Turns ON when MC protocol is set for serial communication.	×	○	R
SM8510	Serial communication error (CH2)	OFF: No error ON: Error	○	○	R
SM8513	Absence/presence of MC protocol (CH2)	Turns ON when MC protocol is set for serial communication.	○	○	R
SM8520	Serial communication error (CH3)	OFF: No error ON: Error	○	○	R
SM8523	Absence/presence of MC protocol (CH3)	Turns ON when MC protocol is set for serial communication.	○	○	R
SM8530	Serial communication error (CH4)	OFF: No error ON: Error	○	○	R
SM8533	Absence/presence of MC protocol (CH4)	Turns ON when MC protocol is set for serial communication.	○	○	R
SM8560	Data transfer delayed (CH1)	This device remains ON while the PLC is waiting to send.	×	○	R
SM8561	Data transfer flag (CH1)	When this device is set to ON, the PLC starts to send.	×	○	R/W
SM8562	Receive completion flag (CH1)	This device turns ON when receiving is completed.	×	○	R/W
SM8563	Carrier detection flag (CH1)	This device turns ON in synchronization with the CD (DCD) signal.	×	○	R
SM8564	Data set ready flag (CH1)	This device turns ON in synchronization with the DR (DSR) signal.	×	○	R
SM8565	Time-out check flag (CH1)	This device turns ON when data receiving is suspended and the next set of receive data is not given within the time set by the time-out time setting device.	×	○	R
SM8570	Data transfer delayed (CH2)	This device remains ON while the PLC is waiting to send.	○	○	R
SM8571	Data transfer flag (CH2)	When this device is set to ON, the PLC starts to send.	○	○	R/W
SM8572	Receive completion flag (CH2)	This device turns ON when receiving is completed.	○	○	R/W
SM8573	Carrier detection flag (CH2)	This device turns ON in synchronization with the CD (DCD) signal.	○	○	R
SM8574	Data set ready flag (CH2)	This device turns ON in synchronization with the DR (DSR) signal.	○	○	R
SM8575	Time-out check flag (CH2)	This device turns ON when data receiving is suspended and the next set of receive data is not given within the time set by the time-out time setting device.	○	○	R

No.	Name	Description	Function support		R/W
			FX5UJ	FX5U/ FX5UC*1	
SM8580	Data transfer delayed (CH3)	This device remains ON while the PLC is waiting to send.	○	○	R
SM8581	Data transfer flag (CH3)	When this device is set to ON, the PLC starts to send.	○	○	R/W
SM8582	Receive completion flag (CH3)	This device turns ON when receiving is completed.	○	○	R/W
SM8583	Carrier detection flag (CH3)	This device turns ON in synchronization with the CD (DCD) signal.	○	○	R
SM8584	Data set ready flag (CH3)	This device turns ON in synchronization with the DR (DSR) signal.	○	○	R
SM8585	Time-out check flag (CH3)	This device turns ON when data receiving is suspended and the next set of receive data is not given within the time set by the time-out time setting device.	○	○	R
SM8590	Data transfer delayed (CH4)	This device remains ON while the PLC is waiting to send	○	○	R
SM8591	Data transfer flag (CH4)	When this device is set to ON, the PLC starts to send	○	○	R/W
SM8592	Receive completion flag (CH4)	This device turns ON when receiving is completed	○	○	R/W
SM8593	Carrier detection flag (CH4)	This device turns ON in synchronization with the CD (DCD) signal	○	○	R
SM8594	Data set ready flag (CH4)	This device turns ON in synchronization with the DR (DSR) signal	○	○	R
SM8595	Time-out check flag (CH4)	This device turns ON when data receiving is suspended and the next set of receive data is not given within the time set by the time-out time setting device	○	○	R
SM8680	Global ON (CH1)	Turns ON when the global command is received.	×	○	R
SM8690	Global ON (CH2)	Turns ON when the global command is received.	○	○	R
SM8700	Global ON (CH3)	Turns ON when the global command is received.	○	○	R
SM8710	Global ON (CH4)	Turns ON when the global command is received.	○	○	R
SM8740	Station No. setting SD latch enabled (CH1)	OFF: Latch disabled ON: Latch enabled	×	○	R
SM8750	Station No. setting SD latch enabled (CH2)	OFF: Latch disabled ON: Latch enabled	○	○	R
SM8760	Station No. setting SD latch enabled (CH3)	OFF: Latch disabled ON: Latch enabled	○	○	R
SM8770	Station No. setting SD latch enabled (CH4)	OFF: Latch disabled ON: Latch enabled	○	○	R
SM8800	MODBUS RTU communication (CH1)	OFF: Communication stop ON: Communication	×	○	R
SM8801	Retry (CH1)	OFF: No retry ON: Retry	×	○	R
SM8802	Timeout (CH1)	OFF: No timeout ON: Timeout	×	○	R
SM8810	MODBUS RTU communication (CH2)	OFF: Communication stop ON: Communication	○	○	R
SM8811	Retry (CH2)	OFF: No retry ON: Retry	○	○	R
SM8812	Timeout (CH2)	OFF: Not timeout ON: Timeout	○	○	R
SM8820	MODBUS RTU communication (CH3)	OFF: Communication stop ON: Communication	○	○	R
SM8821	Retry (CH3)	OFF: No retry ON: Retry	○	○	R
SM8822	Timeout (CH3)	OFF: No timeout ON: Timeout	○	○	R
SM8830	MODBUS RTU communication (CH4)	OFF: Communication stop ON: Communication	○	○	R

No.	Name	Description	Function support		R/W
			FX5UJ	FX5U/ FX5UC*1	
SM8831	Retry (CH4)	OFF: No retry ON: Retry	○	○	R
SM8832	Timeout (CH4)	OFF: No timeout ON: Timeout	○	○	R
SM8861	Host station No. setting SD latch enabled (CH1)	OFF: Latch disabled ON: Latch enabled	×	○	*2
SM8871	Host station No. setting SD latch enabled (CH2)	OFF: Latch disabled ON: Latch enabled	○	○	*2
SM8881	Host station No. setting SD latch enabled (CH3)	OFF: Latch disabled ON: Latch enabled	○	○	*2
SM8891	Host station No. setting SD latch enabled (CH4)	OFF: Latch disabled ON: Latch enabled	○	○	*2
SM8920	Inverter communication (CH1)	OFF: No communication ON: Communication	×	○	R
SM8921	IVBWR instruction error (CH1)	OFF: No error ON: Error	×	○	R
SM8930	Inverter communication (CH2)	OFF: No communication ON: Communication	○	○	R
SM8931	IVBWR instruction error (CH2)	OFF: No error ON: Error	○	○	R
SM8940	Inverter communication (CH3)	OFF: No communication ON: Communication	○	○	R
SM8941	IVBWR instruction error (CH3)	OFF: No error ON: Error	○	○	R
SM8950	Inverter communication (CH4)	OFF: No communication ON: Communication	○	○	R
SM8951	IVBWR instruction error (CH4)	OFF: No error ON: Error	○	○	R
SM9040	Data communication error (Master station)	OFF: No error ON: Error	○	○	R
SM9041	Data communication error (Slave station No.1)	OFF: No error ON: Error	○	○	R
SM9042	Data communication error (Slave station No.2)	OFF: No error ON: Error	○	○	R
SM9043	Data communication error (Slave station No.3)	OFF: No error ON: Error	○	○	R
SM9044	Data communication error (Slave station No.4)	OFF: No error ON: Error	○	○	R
SM9045	Data communication error (Slave station No.5)	OFF: No error ON: Error	○	○	R
SM9046	Data communication error (Slave station No.6)	OFF: No error ON: Error	○	○	R
SM9047	Data communication error (Slave station No.7)	OFF: No error ON: Error	○	○	R
SM9056	Data communication in execution	OFF: Data communication in execution ON: Data communication in nonexecution	○	○	R
SM9080	Station No. setting SD latch enabled	OFF: Latch disabled ON: Latch enabled	○	○	R
SM9081	Slave station total number setting SD latch enabled	OFF: Latch disabled ON: Latch enabled	○	○	R
SM9090	Parallel link operation	OFF: In stopped state ON: In normal running state	○	○	R

*1 CH2 devices for serial communication are supported only for FX5U CPU module.

*2 Latch disabled: R, Latch enabled: R/W

Data logging function

The special relays for data logging function are shown below.

○: Supported, ×: Not supported

R: Read only, R/W: Read/Write

No.	Name	Description	Function support		R/W
			FX5UJ	FX5U/ FX5UC	
SM9300	Data logging setting No.1 Data logging register/clear flag	OFF: Clear ON: Register	○	○	R/W
SM9301	Data logging setting No.2 Data logging register/clear flag	OFF: Clear ON: Register	○	○	R/W
SM9302	Data logging setting No.3 Data logging register/clear flag	OFF: Clear ON: Register	○	○	R/W
SM9303	Data logging setting No.4 Data logging register/clear flag	OFF: Clear ON: Register	○	○	R/W

Data backup/restoration function

The special relays for data backup/restoration function are shown below.

○: Supported, ×: Not supported

R: Read only, R/W: Read/Write

No.	Name	Description	Function support		R/W
			FX5UJ	FX5U/ FX5UC	
SM9350	CPU module auto exchange function enable/disable flag	OFF: Enable ON: Disable	○	○	R/W

Latch area

The special relays for latch area are shown below.

○: Supported, ×: Not supported

R: Read only, R/W: Read/Write

No.	Name	Description	Function support		R/W
			FX5UJ	FX5U/ FX5UC	
SM9353	Clear/keep of latch label during PC write	OFF: Clear ON: Keep	○	○	R/W

Extended file register function

The special relays for extended file register function are shown below.

○: Supported, ×: Not supported

R: Read only, R/W: Read/Write

No.	Name	Description	Function support		R/W
			FX5UJ	FX5U/ FX5UC	
SM9366	Extended file register (ER) access flag	Turns ON while the extended file register (ER) is being accessed.	○	○	R

CC-Link IE Field Network Basic function

The special relays for CC-Link IE Field Network Basic function are shown below.

○: Supported, ×: Not supported

R: Read only, R/W: Read/Write

No.	Name	Description	Function support		R/W
			FX5UJ	FX5U/ FX5UC	
SM9400	CC-Link IE Field Network Basic communication interval setting enable/disable flag (Setting value)	OFF: Disable ON: Enable	○	○	R/W
SM9401	CC-Link IE Field Network Basic communication interval setting enable/disable flag (Current value)	OFF: Disable ON: Enable	○	○	R

Appendix 2 Special Register List

Diagnostic information

The special registers for diagnostic information are shown below.

○: Supported, ×: Not supported

R: Read only, R/W: Read/Write

No.	Name	Description	Function support		R/W
			FX5UJ	FX5U/ FX5UC	
SD0	Latest self diagnostics error code	This register stores the latest self-diagnosis error code.	○	○	R
SD1	Clock time for self diagnosis error occurrence (Year)	This register stores the latest self-diagnosis error time (Year).	○	○	R
SD2	Clock time for self diagnosis error occurrence (Month)	This register stores the latest self-diagnosis error time (Month).	○	○	R
SD3	Clock time for self diagnosis error occurrence (Day)	This register stores the latest self-diagnosis error time (Day).	○	○	R
SD4	Clock time for self diagnosis error occurrence (Hour)	This register stores the latest self-diagnosis error time (Hour).	○	○	R
SD5	Clock time for self diagnosis error occurrence (Minute)	This register stores the latest self-diagnosis error time (Minute).	○	○	R
SD6	Clock time for self diagnosis error occurrence (Second)	This register stores the latest self-diagnosis error time (Second).	○	○	R
SD7	Clock time for self diagnosis error occurrence (Day Week)	This register stores the latest self-diagnosis error time (Day Week).	○	○	R
SD10	Self diagnostics error code 1	This register stores the self-diagnosis error code.	○	○	R
SD11	Self diagnostics error code 2	This register stores the self-diagnosis error code.	○	○	R
SD12	Self diagnostics error code 3	This register stores the self-diagnosis error code.	○	○	R
SD13	Self diagnostics error code 4	This register stores the self-diagnosis error code.	○	○	R
SD14	Self diagnostics error code 5	This register stores the self-diagnosis error code.	○	○	R
SD15	Self diagnostics error code 6	This register stores the self-diagnosis error code.	○	○	R
SD16	Self diagnostics error code 7	This register stores the self-diagnosis error code.	○	○	R
SD17	Self diagnostics error code 8	This register stores the self-diagnosis error code.	○	○	R
SD18	Self diagnostics error code 9	This register stores the self-diagnosis error code.	○	○	R
SD19	Self diagnostics error code 10	This register stores the self-diagnosis error code.	○	○	R
SD20	Self diagnostics error code 11	This register stores the self-diagnosis error code.	○	○	R
SD21	Self diagnostics error code 12	This register stores the self-diagnosis error code.	○	○	R
SD22	Self diagnostics error code 13	This register stores the self-diagnosis error code.	○	○	R
SD23	Self diagnostics error code 14	This register stores the self-diagnosis error code.	○	○	R
SD24	Self diagnostics error code 15	This register stores the self-diagnosis error code.	○	○	R
SD25	Self diagnostics error code 16	This register stores the self-diagnosis error code.	○	○	R
SD53	The number of AC/DC DOWN detections	This register stores the number of times of momentary power failure.	○	○	R
SD61	I/O Module Verify Error Module No.	This register stores the I/O module verify error module No..	○	○	R
SD62	Annunciator (F) Detection No.	This register stores the earliest detected annunciator (F) No..	○	○	R
SD63	Annunciator (F) Detection Number	This register stores the number of annunciator (F) detections.	○	○	R
SD64 to SD79	Annunciator (F) Detection No. table	This register stores the annunciator (F) detection No.	○	○	R

No.	Name	Description	Function support		R/W
			FX5UJ	FX5U/ FX5UC	
SD80	Detailed information 1 information category	<ul style="list-style-type: none"> Detailed information 1 information category code is stored. <div style="border: 1px solid black; padding: 2px; margin: 5px 0;"> b15 to b8 b7 to b0 </div> <div style="border: 1px solid black; padding: 2px; margin: 2px 0;"> Not used (fixed to 0) Information category code </div> <ul style="list-style-type: none"> The following codes are stored into the information category code. 0: N/A 1: Program position information 2: Drive number and file name 4: Parameter information 5: System configuration information 6: Number of times information 7: Time information 	○	○	R

No.	Name	Description	Function support		R/W
			FX5UJ	FX5U/ FX5UC	
SD81 to SD111	Detailed information 1	<ul style="list-style-type: none"> Detailed information 1 corresponding to the error code (SD0) is stored. There are six types of information to be stored as shown in the following figures. The type of detailed information 1 can be obtained using SD80 (the value of the "Detailed information 1 information category code" stored in SD80 corresponds to the following figures (1), (2), (4) to (7)). <p>(1) Program location information</p> <p>(2) Drive number and file name</p> <p>(4) Parameter information</p>	○	○	R

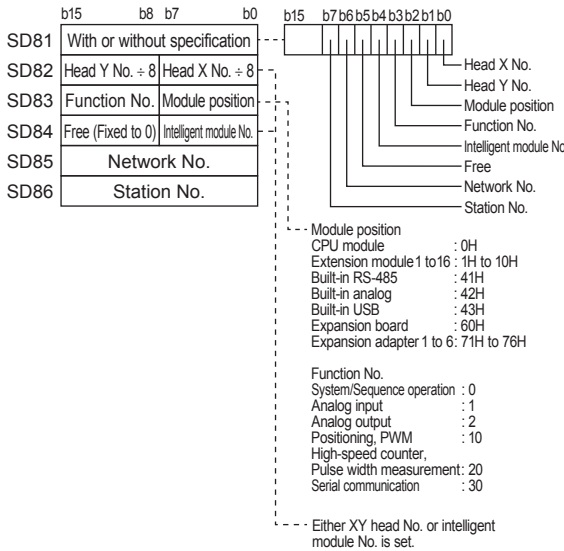
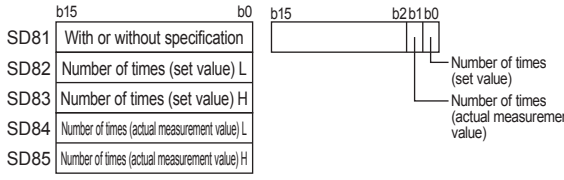
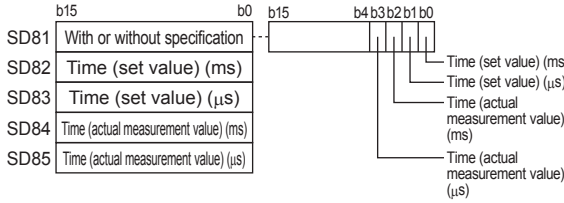
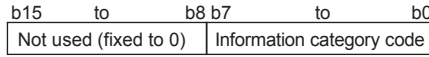
No.	Name	Description	Function support		R/W
			FX5UJ	FX5U/ FX5UC	
SD81 to SD111	Detailed information 1	<p>(5) System configuration information</p>  <p>(6) Number of times information</p>  <p>(7) Time information</p> 	○	○	R
SD112	Detailed information 2 information category	<p>• Detailed information 2 information category code is stored.</p>  <p>• The following codes are stored into the information category code.</p> <p>0: N/A 2: Drive number and file name 3: Annunciator number 4: Parameter information 5: System configuration information</p>	○	○	R



No.	Name	Description	Function support		R/W
			FX5UJ	FX5U/ FX5UC	
SD113 to SD143	Detailed information 2	<ul style="list-style-type: none"> Detailed information 2 corresponding to the error code (SD0) is stored. There are four types of information to be stored as shown in the following figures. The type of detailed information 2 can be obtained using SD112 (the value of the "Detailed information 2 information category code" stored in SD112 corresponds to the following figures (2) to (5)). <p>(2) Drive number and file name</p> <p>(3) Annunciator number</p> <p>(4) Parameter information</p> <p>(5) System configuration information</p>	○	○	R

*1 Fixed to 0 if the SFC program is not used.

System information

The special registers for system information are shown below.

○: Supported, ×: Not supported

R: Read only, R/W: Read/Write

No.	Name	Description	Function support		R/W
			FX5UJ	FX5U/ FX5UC	
SD200	Switch Status	This register stores the CPU switch status. 0: RUN 1: STOP	○	○	R
SD201	LED Status	This register stores the LED status. b2: ERR lit b3: ERR flashing b4: PRUN b5: PAUSE b9: BAT flashing b12: SD memory card available or not removable b13: Preparing SD memory card	○	○	R
SD203	CPU Status	This register stores the CPU Status. 0: RUN 2: STOP 3: PAUSE	○	○	R
SD210	Clock Data (Year)	This register stores the clock data (Year).	○	○	R/W
SD211	Clock Data (Month)	This register stores the clock data (Month).	○	○	R/W
SD212	Clock Data (Day)	This register stores the clock data (Day).	○	○	R/W
SD213	Clock Data (Hour)	This register stores the clock data (Hour).	○	○	R/W
SD214	Clock Data (Minute)	This register stores the clock data (Minute).	○	○	R/W
SD215	Clock Data (Second)	This register stores the clock data (Second).	○	○	R/W
SD216	Clock Data (Day Week)	This register stores the clock data (Day of the Week).	○	○	R/W
SD218	Time zone setting value	The time zone setting value specified in the parameter is stored in increments of minutes.	○	○	R
SD250	Loaded Max I/O	This register stores high-order 2 digits of the final I/O number of connected modules +1 in 8-bit binary.	○	○	R
SD260	X Device Size [Lower]	This register stores the number of X device points used as 32-bit value.	○	○	R
SD261	X Device Size [Upper]				
SD262	Y Device Size [Lower]	This register stores the number of Y device points used as 32-bit value.	○	○	R
SD263	Y Device Size [Upper]				
SD264	M Device Size [Lower]	This register stores the number of M device points used as 32-bit value.	○	○	R
SD265	M Device Size [Upper]				
SD266	B Device Size [Lower]	This register stores the number of B device points used as 32-bit value.	○	○	R
SD267	B Device Size [Upper]				
SD268	SB Device Size [Lower]	This register stores the number of SB device points used as 32-bit value.	○	○	R
SD269	SB Device Size [Upper]				
SD270	F Device Size [Lower]	This register stores the number of F device points used as 32-bit value.	○	○	R
SD271	F Device Size [Upper]				
SD274	L Device Size [Lower]	This register stores the number of L device points used as 32-bit value.	○	○	R
SD275	L Device Size [Upper]				
SD280	D Device Size [Lower]	This register stores the number of D device points used as 32-bit value.	○	○	R
SD281	D Device Size [Upper]				
SD282	W Device Size [Lower]	This register stores the number of W device points used as 32-bit value.	○	○	R
SD283	W Device Size [Upper]				
SD284	SW Device Size [Lower]	This register stores the number of SW device points used as 32-bit value.	○	○	R
SD285	SW Device Size [Upper]				
SD288	T Device Size [Lower]	This register stores the number of T device points used as 32-bit value.	○	○	R
SD289	T Device Size [Upper]				

A

No.	Name	Description	Function support		R/W
			FX5UJ	FX5U/ FX5UC	
SD290	ST Device Size [Lower]	This register stores the number of ST device points used as 32-bit value.	○	○	R
SD291	ST Device Size [Upper]				
SD292	C Device Size [Lower]	This register stores the number of C device points used as 32-bit value.	○	○	R
SD293	C Device Size [Upper]				
SD298	LC Device Size [Lower]	This register stores the number of LC device points used as 32-bit value.	○	○	R
SD299	LC Device Size [Upper]				
SD300	Z Device Size	This register stores the number of Z device points used.	○	○	R
SD302	LZ Device Size	This register stores the number of LZ device points used.	○	○	R
SD304	R Device Size [Lower]	This register stores the number of R device points used as 32-bit value.	○	○	R
SD305	R Device Size [Upper]				

System clock

The special registers for system clock are shown below.

○: Supported, ×: Not supported

R: Read only, R/W: Read/Write

No.	Name	Description	Function support		R/W
			FX5UJ	FX5U/ FX5UC	
SD412	One second counter	<ul style="list-style-type: none"> This register is incremented by 1 for each second after the CPU module is set to RUN. A counting cycle from 0 to 32767 to -32768 to 0 is repeated. 	○	○	R
SD414	2n second clock setting	<ul style="list-style-type: none"> Stores value n of 2n second clock (Default is 30) Setting can be made between 1 and 32767. 	○	○	R/W
SD415	2nms second clock setting	<ul style="list-style-type: none"> Stores value n of 2n ms clock (Default is 30) Setting can be made between 1 and 32767. 	○	○	R/W
SD420	Scan counter	<ul style="list-style-type: none"> This register is incremented by 1 each scan after the CPU module is set to RUN. (Not incremented for each scan of an initial execution type program.) A counting cycle from 0 to 32767 to -32768 to 0 is repeated. 	○	○	R

Scan information

The special registers for scan information are shown below.

○: Supported, ×: Not supported

R: Read only, R/W: Read/Write

No.	Name	Description	Function support		R/W
			FX5UJ	FX5U/ FX5UC	
SD518	Initial scan time (ms)	<ul style="list-style-type: none"> The initial scan time is stored into SD518 and SD519 (it is measured in increments of μs). SD518: stores a value in the ms place (storage range: 0 to 65535) SD519: stores a value in the μs place (storage range: 0 to 999) This register is cleared to 0 when the mode transfers from STOP to RUN mode. 	○	○	R
SD519	Initial scan time (μ s)		○	○	R
SD520	Current scan time (ms)	<ul style="list-style-type: none"> The current scan time is stored into SD520 and SD521 (it is measured in increments of μs). SD520: stores a value in the ms place (storage range: 0 to 65535) SD521: stores a value in the μs place (storage range: 0 to 999) Example: If the current scan time is 23.6ms, the following values are stored: SD520 = 23 SD521 = 600 This register is cleared to 0 when the mode transfers from STOP to RUN mode. 	○	○	R
SD521	Current scan time (μ s)		○	○	R

No.	Name	Description	Function support		R/W
			FX5UJ	FX5U/ FX5UC	
SD522	Minimum scan time (ms)	<ul style="list-style-type: none"> The minimum value of the scan time other than that of the initial execution program is stored into SD522 and SD523 (it is measured in increments of μs). SD522: stores a value in the ms place (storage range: 0 to 65535) SD523: stores a value in the μ s place (storage range: 0 to 999) <ul style="list-style-type: none"> This register is cleared to 0 when the mode transfers from STOP to RUN mode. 	○	○	R
SD523	Minimum scan time(μ s)		○	○	R
SD524	Maximum scan time (ms)	<ul style="list-style-type: none"> The maximum value of the scan time other than that of the initial execution program is stored into SD524 and SD525 (it is measured in increments of μs). SD524: stores a value in the ms place (storage range: 0 to 65535) SD525: stores a value in the μ s place (storage range: 0 to 999) <ul style="list-style-type: none"> This register is cleared to 0 when the mode transfers from STOP to RUN mode. 	○	○	R
SD525	Maximum scan time (μ s)		○	○	R
SD526	END processing time (ms)	<ul style="list-style-type: none"> The time period from completion of a scan program until start of the next scan is stored into SD526 to SD527 (it is measured in increments of μs). SD526: stores a value in the ms place (storage range: 0 to 65535) SD527: stores a value in the μ s place (storage range: 0 to 999) <ul style="list-style-type: none"> This register is cleared to 0 when the mode transfers from STOP to RUN mode. 	○	○	R
SD527	END processing time (μ s)		○	○	R
SD528	Constant scan waiting time (ms)	<ul style="list-style-type: none"> The waiting time specified in the constant scan setting process is stored into SD528 and SD529 (it is measured in increments of μs). SD528: stores a value in the ms place (storage range: 0 to 65535) SD529: stores a value in the μ s place (storage range: 0 to 999) <ul style="list-style-type: none"> This register is cleared to 0 when the mode transfers from STOP to RUN mode. 	○	○	R
SD529	Constant scan waiting time (μ s)		○	○	R
SD530	Scan program execution time (ms)	<ul style="list-style-type: none"> The execution time of the scan program for one scan is stored into SD530 and SD531 (it is measured in increments of μs). SD530: stores a value in the ms place (storage range: 0 to 65535) SD531: stores a value in the μ s place (storage range: 0 to 999) <ul style="list-style-type: none"> This register is cleared to 0 when the mode transfers from STOP to RUN mode. 	○	○	R
SD531	Scan program execution time (μ s)		○	○	R



Drive information

The special registers for drive information are shown below.

○: Supported, ×: Not supported

R: Read only, R/W: Read/Write

No.	Name	Description	Function support		R/W
			FX5UJ	FX5U/ FX5UC	
SD600	Memory Card Installation	This register stores the enable/disable classification of the inserted SD card.	○	○	R
SD604	SD memory card usage status	This register stores the memory card usage condition. b0: SD memory card in use	○	○	R
SD606	SD memory card capacity	This register stores the drive 2 storage capacity (unit: 1 K byte). (Free space value after formatting is stored.)	○	○	R
SD607	SD memory card capacity	This register stores the drive 2 storage capacity (unit: 1 K byte). (Free space value after formatting is stored.)	○	○	R
SD608	SD memory card capacity	This register stores the drive 2 storage capacity (unit: 1 K byte). (Free space value after formatting is stored.)	○	○	R
SD609	SD memory card capacity	This register stores the drive 2 storage capacity (unit: 1 K byte). (Free space value after formatting is stored.)	○	○	R
SD610	SD memory card free space capacity	This register stores the free space value in drive 2 (unit: 1 K byte).	○	○	R
SD611	SD memory card free space capacity	This register stores the free space value in drive 2 (unit: 1 K byte).	○	○	R
SD612	SD memory card free space capacity	This register stores the free space value in drive 2 (unit: 1 K byte).	○	○	R
SD613	SD memory card free space capacity	This register stores the free space value in drive 2 (unit: 1 K byte).	○	○	R
SD634	Index for the number of data memory write operations	Stores an index for the number of write operations to data memory currently. However, the index does not equal the actual number of write operations.	○	○	R
SD635					

Instruction related

The special registers related to instruction execution are shown below.

○: Supported, ×: Not supported

R: Read only, R/W: Read/Write

No.	Name	Description	Function support		R/W
			FX5UJ	FX5U/ FX5UC	
SD757	Current interrupt priority	This register stores the interrupt priority of the interrupt program being executed. 1 to 3: The interrupt priority of interrupt program executed. 0: The interrupt is not executed. (default value)	○	○	R
SD758	Interrupt disabling for each priority setting value	This register stores the disable interrupt priority according to the disable interrupt instruction (DI), disable interrupt after the setting priority instruction (DI), and enable interrupt instruction (EI). 1: Disable interrupt priority 1 or less. (Disable interrupt of all priority) (default value) 2: Disable interrupt priority 2 or 3. 3: Disable interrupt priority 3. 0: No priority. (Enable interrupt of all priority)	○	○	R
SD771	Specification of the number of write instruction executions to data memory	This register stores the setting value of limitation in the number of write operations in one day by instruction executions.	○	○	R/W

Latch area

The special registers for latch area are shown below.

○: Supported, ×: Not supported

R: Read only, R/W: Read/Write

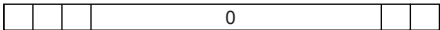
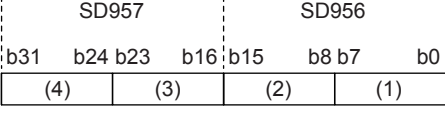
No.	Name	Description	Function support		R/W
			FX5UJ	FX5U/ FX5UC	
SD953	Backup error cause	The cause of the error that occurred during the data backup is stored. • 0: No error • Other than 0: Error codes "0" is set at the start of the data backup.	○	○	R
SD954	Restoration target data setting	Set the target data to be restored with the data restoration function. 0: All target data 1: Device/label data only 2: All target data except for the device/label data	○	○	R/W
SD955	Restoration function setting	Set the data restoration function using the following bit pattern. (OFF: Disabled, ON: Enabled) <div style="text-align: center;"> b15 b14 b13 b1 b0  </div> b0: Auto restoration request b1: Initialization setting at the automatic restoration b13: Restoration target folder b14: Restoration for the special relay and special register b15: Setting of operation after restoration	○	○	R/W
SD956 SD957	Restoration target date folder setting	Store the target folder (date folder) of the data restoration using BCD code. <div style="text-align: center;">  </div> (1) Day (1 to 31) (2) Month (1 to 12) (3) Year (last two digits) (0 to 99) (4) Year (first two digits) (0 to 99) [Example] To specify the date folder of June 15 2015, store "20150615H".	○	○	R/W
SD958	Restoration target number folder setting	Specify the target folder of the data restoration. 1 to 32767: Serial number of the backup folder (*****) in a date folder (00001 to 32767)	○	○	R/W
SD959	Restoration error cause	The cause of the error that occurred during the data restoration is stored. • 0: No error • Other than 0: Error codes "0" is set at the start of the data backup.	○	○	R



Data logging function

The special registers for data logging function are shown below.

○: Supported, ×: Not supported

R: Read only, R/W: Read/Write

No.	Name	Description	Function support		R/W
			FX5UJ	FX5U/ FX5UC	
SD1210	Data logging setting No.1 Latest storage file number [Low-order]	This register stores the latest storage file number.	○	○	R
SD1211	Data logging setting No.1 Latest storage file number [High-order]				
SD1212	Data logging setting No.1 Oldest storage file number [Low-order]	This register stores the oldest storage file number.	○	○	R
SD1213	Data logging setting No.1 Oldest storage file number [High-order]				
SD1214	Data logging setting No.1 Internal buffer free space	This register stores the free space size of the internal buffer (K bytes).	○	○	R
SD1215	Data logging setting No.1 Number of processing overflow occurrences	This register stores the number of processing overflow occurrences.	○	○	R
SD1216	Data logging setting No.1 Data logging error cause	This register stores the data logging error cause. 0: No error Other than 0: Error codes	○	○	R
SD1220 to SD1226	Data logging setting No.2	Same configuration as the setting No.1	○	○	R
SD1230 to SD1236	Data logging setting No.3	Same configuration as the setting No.1	○	○	R
SD1240 to SD1246	Data logging setting No.4	Same configuration as the setting No.1	○	○	R

Data backup/restoration function

The special registers for data backup/restoration function are shown below.

○: Supported, ×: Not supported

R: Read only, R/W: Read/Write

No.	Name	Description	Function support		R/W
			FX5UJ	FX5U/ FX5UC	
SD1350	Number of uncompleted folders/files of CPU module data backup/restoration	This register indicates the number of folders/files where the backup/restoration of the CPU module is not completed. When the backup/restoration processing is started, the total number of folders and files to be backed up or restored is stored. The number is reduced one each time one folder/file is backed up or restored, and 0 is stored when all the data is backed up or restored.	○	○	R
SD1351	Progression status of CPU module data backup/restoration	This register indicates the progression status of the backup or restoration as a percentage. (Range of the value: 0 to 100 (%)) "0" is set at the start of CPU module data backup/restore.	○	○	R

Mask pattern of interrupt pointers

The special registers for the mask pattern of interrupt pointers are shown below.

○: Supported, ×: Not supported

R: Read only, R/W: Read/Write

No.	Name	Description	Function support		R/W
			FX5UJ	FX5U/ FX5UC	
SD1400	IMASK instruction mask pattern	This register stores the IMASK instruction mask pattern. b15 to b0: I15 to I0	○	○	R
SD1401	IMASK instruction mask pattern	This register stores the IMASK instruction mask pattern. b15 to b0: I31 to I16	○	○	R
SD1403	IMASK instruction mask pattern	This register stores the IMASK instruction mask pattern. b15 to b0: I63 to I50	○	○	R
SD1404	IMASK instruction mask pattern	This register stores the IMASK instruction mask pattern. b15 to b0: I79 to I64	○	○	R
SD1405	IMASK instruction mask pattern	This register stores the IMASK instruction mask pattern. b15 to b0: I95 to I80	○	○	R
SD1406	IMASK instruction mask pattern	This register stores the IMASK instruction mask pattern. b15 to b0: I111 to I96	○	○	R
SD1407	IMASK instruction mask pattern	This register stores the IMASK instruction mask pattern. b15 to b0: I127 to I112	○	○	R
SD1408	IMASK instruction mask pattern	This register stores the IMASK instruction mask pattern. b15 to b0: I143 to I128	○	○	R
SD1409	IMASK instruction mask pattern	This register stores the IMASK instruction mask pattern. b15 to b0: I159 to I144	○	○	R
SD1410	IMASK instruction mask pattern	This register stores the IMASK instruction mask pattern. b15 to b0: I175 to I160	○	○	R
SD1411	IMASK instruction mask pattern	This register stores the IMASK instruction mask pattern. b0: I176 b0: I177	○	○	R

A

Memory dump function

The special registers for memory dump function are shown below.

○: Supported, ×: Not supported

R: Read only, R/W: Read/Write

No.	Name	Description	Function support		R/W
			FX5UJ	FX5U/ FX5UC	
SD1472	Memory dump error cause	The cause of the error that occurred during the memory dump function is stored. 0: No error Other than 0: Error codes	○	○	R

Real-time monitor function

The special registers for real-time monitor function are shown below.

○: Supported, ×: Not supported

R: Read only, R/W: Read/Write

No.	Name	Description	Function support		R/W
			FX5UJ	FX5U/ FX5UC	
SD1484	Real-time monitor internal buffer free space	The amount of free space of the internal buffer is stored in K bytes. The smaller the value, the higher the generating ratio of processing overflow.	○	○	R

CC-Link IE Field Network Basic function

The special registers for CC-Link IE Field Network Basic function are shown below.

○: Supported, ×: Not supported

R: Read only, R/W: Read/Write

No.	Name	Description	Function support		R/W																		
			FX5UJ	FX5U/ FX5UC																			
SD1536	Cyclic transmission status of each station	<p>The cyclic transmission status of each station is stored using the following bit pattern. (OFF: Not performed, ON: Being performed)</p> <table border="1" style="margin-left: 20px;"> <tr> <td style="text-align: center;">b15</td> <td style="text-align: center;">b14</td> <td style="text-align: center;">to</td> <td style="text-align: center;">b5</td> <td style="text-align: center;">b4</td> <td style="text-align: center;">b3</td> <td style="text-align: center;">b2</td> <td style="text-align: center;">b1</td> <td style="text-align: center;">b0</td> </tr> <tr> <td style="text-align: center;">16</td> <td style="text-align: center;">15</td> <td style="text-align: center;">to</td> <td style="text-align: center;">6</td> <td style="text-align: center;">5</td> <td style="text-align: center;">4</td> <td style="text-align: center;">3</td> <td style="text-align: center;">2</td> <td style="text-align: center;">1</td> </tr> </table> <p>The numbers in the figure indicate station numbers.</p> <p>(Target)</p> <ul style="list-style-type: none"> FX5UJ CPU module: b7 to b0 FX5U/FX5UC CPU module: b15 to b0 <p>(Condition)</p> <ul style="list-style-type: none"> Only the bit of the start station number turns on. The status is not stored for the reserved stations and the station numbers after the maximum station number. <p>Use this register as an interlock for cyclic transmission. For details on the interlock program, refer to the following.</p> <p> CC-Link IE Field Network Basic Reference Manual</p>	b15	b14	to	b5	b4	b3	b2	b1	b0	16	15	to	6	5	4	3	2	1	○	○	R
b15	b14	to	b5	b4	b3	b2	b1	b0															
16	15	to	6	5	4	3	2	1															
SD1540	Data link status for each station	<p>The data link status of each station is stored using the following bit pattern. (Off: Normally operating station^{*1}, On: Faulty station)</p> <table border="1" style="margin-left: 20px;"> <tr> <td style="text-align: center;">b15</td> <td style="text-align: center;">b14</td> <td style="text-align: center;">to</td> <td style="text-align: center;">b5</td> <td style="text-align: center;">b4</td> <td style="text-align: center;">b3</td> <td style="text-align: center;">b2</td> <td style="text-align: center;">b1</td> <td style="text-align: center;">b0</td> </tr> <tr> <td style="text-align: center;">16</td> <td style="text-align: center;">15</td> <td style="text-align: center;">to</td> <td style="text-align: center;">6</td> <td style="text-align: center;">5</td> <td style="text-align: center;">4</td> <td style="text-align: center;">3</td> <td style="text-align: center;">2</td> <td style="text-align: center;">1</td> </tr> </table> <p>The numbers in the figure indicate station numbers.</p> <p>(Target)</p> <ul style="list-style-type: none"> FX5UJ CPU module: b7 to b0 FX5U/FX5UC CPU module: b15 to b0 <p>(Condition)</p> <ul style="list-style-type: none"> Only the bit of the start station number turns on. The status is not stored for the reserved stations and the station numbers after the maximum station number. <p>This register can be used to monitor errors in slave stations, connected cables, and a connected hub.</p>	b15	b14	to	b5	b4	b3	b2	b1	b0	16	15	to	6	5	4	3	2	1	○	○	R
b15	b14	to	b5	b4	b3	b2	b1	b0															
16	15	to	6	5	4	3	2	1															

*1 This status includes the case where a slave station has not responded to the first request from the master station due to a power-off of the slave station. (The slave station is not judged as a faulty station because the data link status is not determined.)

FX dedicated

The special registers dedicated to FX are shown below.

○: Supported, ×: Not supported

R: Read only, R/W: Read/Write

No.	Name	Description	Function support		R/W
			FX5UJ	FX5U/ FX5UC	
SD4110	Error code 1 details	This register stores the self-diagnosis error code details. • Module position [Low order 8 bit] 0H: CPU module 1H to 10H: Extension module 1 to 16 41H: Built-in RS-485 42H: Built-in analog 43H: Built-in USB 60H: Expansion board 71H to 76H: Expansion adapter 1 to 6 • Function No. [Higher order 8 bit] 0: System/Sequence operation 1: Analog input 2: Analog output 10: Positioning, PWM 20: High-speed counter, Pulse width measurement	○	○	R
SD4111	Error code 2 details				
SD4112	Error code 3 details				
SD4113	Error code 4 details				
SD4114	Error code 5 details				
SD4115	Error code 6 details				
SD4116	Error code 7 details				
SD4117	Error code 8 details				
SD4118	Error code 9 details				
SD4119	Error code 10 details				
SD4120	Error code 11 details				
SD4121	Error code 12 details				
SD4122	Error code 13 details				
SD4123	Error code 14 details				
SD4124	Error code 15 details				
SD4125	Error code 16 details				
SD4150	Module 1 status information	This register stores the module 1 status information.	○	○	R
SD4151	Module 1 error information	This register stores the module 1 error information.	○	○	R
SD4152	Module 2 status information	This register stores the module 2 status information.	○	○	R
SD4153	Module 2 error information	This register stores the module 2 error information.	○	○	R
SD4154	Module 3 status information	This register stores the module 3 status information.	○	○	R
SD4155	Module 3 error information	This register stores the module 3 error information.	○	○	R
SD4156	Module 4 status information	This register stores the module 4 status information.	○	○	R
SD4157	Module 4 error information	This register stores the module 4 error information.	○	○	R
SD4158	Module 5 status information	This register stores the module 5 status information.	○	○	R
SD4159	Module 5 error information	This register stores the module 5 error information.	○	○	R
SD4160	Module 6 status information	This register stores the module 6 status information.	○	○	R
SD4161	Module 6 error information	This register stores the module 6 error information.	○	○	R
SD4162	Module 7 status information	This register stores the module 7 status information.	○	○	R
SD4163	Module 7 error information	This register stores the module 7 error information.	○	○	R
SD4164	Module 8 status information	This register stores the module 8 status information.	○	○	R
SD4165	Module 8 error information	This register stores the module 8 error information.	○	○	R
SD4166	Module 9 status information	This register stores the module 9 status information.	×	○	R
SD4167	Module 9 error information	This register stores the module 9 error information.	×	○	R
SD4168	Module 10 status information	This register stores the module 10 status information.	×	○	R
SD4169	Module 10 error information	This register stores the module 10 error information.	×	○	R
SD4170	Module 11 status information	This register stores the module 11 status information.	×	○	R
SD4171	Module 11 error information	This register stores the module 11 error information.	×	○	R
SD4172	Module 12 status information	This register stores the module 12 status information.	×	○	R
SD4173	Module 12 error information	This register stores the module 12 error information.	×	○	R
SD4174	Module 13 status information	This register stores the module 13 status information.	×	○	R
SD4175	Module 13 error information	This register stores the module 13 error information.	×	○	R
SD4176	Module 14 status information	This register stores the module 14 status information.	×	○	R
SD4177	Module 14 error information	This register stores the module 14 error information.	×	○	R
SD4178	Module 15 status information	This register stores the module 15 status information.	×	○	R
SD4179	Module 15 error information	This register stores the module 15 error information.	×	○	R

A

No.	Name	Description	Function support		R/W
			FX5UJ	FX5U/ FX5UC	
SD4180	Module 16 status information	This register stores the module 16 status information.	×	○	R
SD4181	Module 16 error information	This register stores the module 16 error information.	×	○	R
SD4210	All module reset command permission code	This register stores the code for permission to reset all modules other than the CPU module. 0H: Reset disable F5F5H: Reset enable (reset execution by turning ON SM4210)	×	○	R/W
SD4462	Cumulative operating time [Lower]	This register stores the cumulative operating time (unit: second).	○	○	R
SD4463	Cumulative operating time [Upper]				

FX high-speed input/output

The special registers for FX high-speed input/output are shown below.

○: Supported, ×: Not supported

R: Read only, R/W: Read/Write

No.	Name	Description	Function support		R/W
			FX5UJ	FX5U/ FX5UC	
SD4500	High-speed counter current value [Low-order] (CH1)	This register stores the high-speed counter current value (CH1).	○	○	R/W
SD4501	High-speed counter current value [High-order] (CH1)				
SD4502	High-speed counter maximum value [Low-order] (CH1)	This register stores the high-speed counter maximum value (CH1).	○	○	R/W
SD4503	High-speed counter maximum value [High-order] (CH1)				
SD4504	High-speed counter minimum value [Low-order] (CH1)	This register stores the high-speed counter minimum value (CH1).	○	○	R/W
SD4505	High-speed counter minimum value [High-order] (CH1)				
SD4506	High-speed counter pulse density [Low-order] (CH1)	This register stores the high-speed counter pulse density (CH1).	○	○	R/W
SD4507	High-speed counter pulse density [High-order] (CH1)				
SD4508	High-speed counter rotation speed [Low-order] (CH1)	This register stores the high-speed counter rotation speed (CH1).	○	○	R/W
SD4509	High-speed counter rotation speed [High-order] (CH1)				
SD4510	High-speed counter preset control switch (CH1)	This register stores the high-speed counter preset control switch (CH1).	○	○	R/W
SD4512	High-speed counter preset value [Low-order] (CH1)	This register stores the high-speed counter preset value (CH1).	○	○	R/W
SD4513	High-speed counter preset value [High-order] (CH1)				
SD4514	High-speed counter ring length [Low-order] (CH1)	This register stores the high-speed counter ring length (CH1).	○	○	R/W
SD4515	High-speed counter ring length [High-order] (CH1)				
SD4516	High-speed counter measurement-unit time [Low-order] (CH1)	This register stores the high-speed counter measurement-unit time (CH1).	○	○	R/W
SD4517	High-speed counter measurement-unit time [High-order] (CH1)				
SD4518	High-speed counter number of pulses per rotation [Low-order] (CH1)	This register stores the high-speed counter number of pulses per rotation (CH1).	○	○	R/W
SD4519	High-speed counter number of pulses per rotation [High-order] (CH1)				
SD4530	High-speed counter current value [Low-order] (CH2)	This register stores the high-speed counter current value (CH2).	○	○	R/W
SD4531	High-speed counter current value [High-order] (CH2)				
SD4532	High-speed counter maximum value [Low-order] (CH2)	This register stores the high-speed counter maximum value (CH2).	○	○	R/W
SD4533	High-speed counter maximum value [High-order] (CH2)				
SD4534	High-speed counter minimum value [Low-order] (CH2)	This register stores the high-speed counter minimum value (CH2).	○	○	R/W
SD4535	High-speed counter minimum value [High-order] (CH2)				
SD4536	High-speed counter pulse density [Low-order] (CH2)	This register stores the high-speed counter pulse density (CH2).	○	○	R/W
SD4537	High-speed counter pulse density [High-order] (CH2)				
SD4538	High-speed counter rotation speed [Low-order] (CH2)	This register stores the high-speed counter rotation speed (CH2).	○	○	R/W
SD4539	High-speed counter rotation speed [High-order] (CH2)				
SD4540	High-speed counter preset control switch (CH2)	This register stores the high-speed counter preset control switch (CH2).	○	○	R/W
SD4542	High-speed counter preset value [Low-order] (CH2)	This register stores the high-speed counter preset value (CH2).	○	○	R/W
SD4543	High-speed counter preset value [High-order] (CH2)				

No.	Name	Description	Function support		R/W
			FX5UJ	FX5U/ FX5UC	
SD4544	High-speed counter ring length [Low-order] (CH2)	This register stores the high-speed counter ring length (CH2).	○	○	R/W
SD4545	High-speed counter ring length [High-order] (CH2)				
SD4546	High-speed counter measurement-unit time [Low-order] (CH2)	This register stores the high-speed counter measurement-unit time (CH2).	○	○	R/W
SD4547	High-speed counter measurement-unit time [High-order] (CH2)				
SD4548	High-speed counter number of pulses per rotation [Low-order] (CH2)	This register stores the high-speed counter number of pulses per rotation (CH2).	○	○	R/W
SD4549	High-speed counter number of pulses per rotation [High-order] (CH2)				
SD4560	High-speed counter current value [Low-order] (CH3)	This register stores the high-speed counter current value (CH3).	○	○	R/W
SD4561	High-speed counter current value [High-order] (CH3)				
SD4562	High-speed counter maximum value [Low-order] (CH3)	This register stores the high-speed counter maximum value (CH3).	○	○	R/W
SD4563	High-speed counter maximum value [High-order] (CH3)				
SD4564	High-speed counter minimum value [Low-order] (CH3)	This register stores the high-speed counter minimum value (CH3).	○	○	R/W
SD4565	High-speed counter minimum value [High-order] (CH3)				
SD4566	High-speed counter pulse density [Low-order] (CH3)	This register stores the high-speed counter pulse density (CH3).	○	○	R/W
SD4567	High-speed counter pulse density [High-order] (CH3)				
SD4568	High-speed counter rotation speed [Low-order] (CH3)	This register stores the high-speed counter rotation speed (CH3).	○	○	R/W
SD4569	High-speed counter rotation speed [High-order] (CH3)				
SD4570	High-speed counter preset control switch (CH3)	This register stores the high-speed counter preset control switch (CH3).	○	○	R/W
SD4572	High-speed counter preset value [Low-order] (CH3)	This register stores the high-speed counter preset value (CH3).	○	○	R/W
SD4573	High-speed counter preset value [High-order] (CH3)				
SD4574	High-speed counter ring length [Low-order] (CH3)	This register stores the high-speed counter ring length (CH3).	○	○	R/W
SD4575	High-speed counter ring length [High-order] (CH3)				
SD4576	High-speed counter measurement-unit time [Low-order] (CH3)	This register stores the high-speed counter measurement-unit time (CH3).	○	○	R/W
SD4577	High-speed counter measurement-unit time [High-order] (CH3)				
SD4578	High-speed counter number of pulses per rotation [Low-order] (CH3)	This register stores the high-speed counter number of pulses per rotation (CH3).	○	○	R/W
SD4579	High-speed counter number of pulses per rotation [High-order] (CH3)				
SD4590	High-speed counter current value [Low-order] (CH4)	This register stores the high-speed counter current value (CH4).	○	○	R/W
SD4591	High-speed counter current value [High-order] (CH4)				
SD4592	High-speed counter maximum value [Low-order] (CH4)	This register stores the high-speed counter maximum value (CH4).	○	○	R/W
SD4593	High-speed counter maximum value [High-order] (CH4)				
SD4594	High-speed counter minimum value [Low-order] (CH4)	This register stores the high-speed counter minimum value (CH4).	○	○	R/W
SD4595	High-speed counter minimum value [High-order] (CH4)				
SD4596	High-speed counter pulse density [Low-order] (CH4)	This register stores the high-speed counter pulse density (CH4).	○	○	R/W
SD4597	High-speed counter pulse density [High-order] (CH4)				
SD4598	High-speed counter rotation speed [Low-order] (CH4)	This register stores the high-speed counter rotation speed (CH4).	○	○	R/W
SD4599	High-speed counter rotation speed [High-order] (CH4)				
SD4600	High-speed counter preset control switch (CH4)	This register stores the high-speed counter preset control switch (CH4).	○	○	R/W
SD4602	High-speed counter preset value [Low-order] (CH4)	This register stores the high-speed counter preset value (CH4).	○	○	R/W
SD4603	High-speed counter preset value [High-order] (CH4)				
SD4604	High-speed counter ring length [Low-order] (CH4)	This register stores the high-speed counter ring length (CH4).	○	○	R/W
SD4605	High-speed counter ring length [High-order] (CH4)				
SD4606	High-speed counter measurement-unit time [Low-order] (CH4)	This register stores the high-speed counter measurement-unit time (CH4).	○	○	R/W
SD4607	High-speed counter measurement-unit time [High-order] (CH4)				
SD4608	High-speed counter number of pulses per rotation [Low-order] (CH4)	This register stores the high-speed counter number of pulses per rotation (CH4).	○	○	R/W
SD4609	High-speed counter number of pulses per rotation [High-order] (CH4)				

No.	Name	Description	Function support		R/W
			FX5UJ	FX5U/ FX5UC	
SD4620	High-speed counter current value [Low-order] (CH5)	This register stores the high-speed counter current value (CH5).	○	○	R/W
SD4621	High-speed counter current value [High-order] (CH5)				
SD4622	High-speed counter maximum value [Low-order] (CH5)	This register stores the high-speed counter maximum value (CH5).	○	○	R/W
SD4623	High-speed counter maximum value [High-order] (CH5)				
SD4624	High-speed counter minimum value [Low-order] (CH5)	This register stores the high-speed counter minimum value (CH5).	○	○	R/W
SD4625	High-speed counter minimum value [High-order] (CH5)				
SD4626	High-speed counter pulse density [Low-order] (CH5)	This register stores the high-speed counter pulse density (CH5).	○	○	R/W
SD4627	High-speed counter pulse density [High-order] (CH5)				
SD4628	High-speed counter rotation speed [Low-order] (CH5)	This register stores the high-speed counter rotation speed (CH5).	○	○	R/W
SD4629	High-speed counter rotation speed [High-order] (CH5)				
SD4630	High-speed counter preset control switch (CH5)	This register stores the high-speed counter preset control switch (CH5).	○	○	R/W
SD4632	High-speed counter preset value [Low-order] (CH5)	This register stores the high-speed counter preset value (CH5).	○	○	R/W
SD4633	High-speed counter preset value [High-order] (CH5)				
SD4634	High-speed counter ring length [Low-order] (CH5)	This register stores the high-speed counter ring length (CH5).	○	○	R/W
SD4635	High-speed counter ring length [High-order] (CH5)				
SD4636	High-speed counter measurement-unit time [Low-order] (CH5)	This register stores the high-speed counter measurement-unit time (CH5).	○	○	R/W
SD4637	High-speed counter measurement-unit time [High-order] (CH5)				
SD4638	High-speed counter number of pulses per rotation [Low-order] (CH5)	This register stores the high-speed counter number of pulses per rotation (CH5).	○	○	R/W
SD4639	High-speed counter number of pulses per rotation [High-order] (CH5)				
SD4650	High-speed counter current value [Low-order] (CH6)	This register stores the high-speed counter current value (CH6).	○	○	R/W
SD4651	High-speed counter current value [High-order] (CH6)				
SD4652	High-speed counter maximum value [Low-order] (CH6)	This register stores the high-speed counter maximum value (CH6).	○	○	R/W
SD4653	High-speed counter maximum value [High-order] (CH6)				
SD4654	High-speed counter minimum value [Low-order] (CH6)	This register stores the high-speed counter minimum value (CH6).	○	○	R/W
SD4655	High-speed counter minimum value [High-order] (CH6)				
SD4656	High-speed counter pulse density [Low-order] (CH6)	This register stores the high-speed counter pulse density (CH6).	○	○	R/W
SD4657	High-speed counter pulse density [High-order] (CH6)				
SD4658	High-speed counter rotation speed [Low-order] (CH6)	This register stores the high-speed counter rotation speed (CH6).	○	○	R/W
SD4659	High-speed counter rotation speed [High-order] (CH6)				
SD4660	High-speed counter preset control switch (CH6)	This register stores the high-speed counter preset control switch (CH6).	○	○	R/W
SD4662	High-speed counter preset value [Low-order] (CH6)	This register stores the high-speed counter preset value (CH6).	○	○	R/W
SD4663	High-speed counter preset value [High-order] (CH6)				
SD4664	High-speed counter ring length [Low-order] (CH6)	This register stores the high-speed counter ring length (CH6).	○	○	R/W
SD4665	High-speed counter ring length [High-order] (CH6)				
SD4666	High-speed counter measurement-unit time [Low-order] (CH6)	This register stores the high-speed counter measurement-unit time (CH6).	○	○	R/W
SD4667	High-speed counter measurement-unit time [High-order] (CH6)				
SD4668	High-speed counter number of pulses per rotation [Low-order] (CH6)	This register stores the high-speed counter number of pulses per rotation (CH6).	○	○	R/W
SD4669	High-speed counter number of pulses per rotation [High-order] (CH6)				
SD4680	High-speed counter current value [Low-order] (CH7)	This register stores the high-speed counter current value (CH7).	○	○	R/W
SD4681	High-speed counter current value [High-order] (CH7)				
SD4682	High-speed counter maximum value [Low-order] (CH7)	This register stores the high-speed counter maximum value (CH7).	○	○	R/W
SD4683	High-speed counter maximum value [High-order] (CH7)				
SD4684	High-speed counter minimum value [Low-order] (CH7)	This register stores the high-speed counter minimum value (CH7).	○	○	R/W
SD4685	High-speed counter minimum value [High-order] (CH7)				
SD4686	High-speed counter pulse density [Low-order] (CH7)	This register stores the high-speed counter pulse density (CH7).	○	○	R/W
SD4687	High-speed counter pulse density [High-order] (CH7)				

No.	Name	Description	Function support		R/W
			FX5UJ	FX5U/ FX5UC	
SD4688	High-speed counter rotation speed [Low-order] (CH7)	This register stores the high-speed counter rotation speed (CH7).	○	○	R/W
SD4689	High-speed counter rotation speed [High-order] (CH7)				
SD4690	High-speed counter preset control switch (CH7)	This register stores the high-speed counter preset control switch (CH7).	○	○	R/W
SD4692	High-speed counter preset value [Low-order] (CH7)	This register stores the high-speed counter preset value (CH7).	○	○	R/W
SD4693	High-speed counter preset value [High-order] (CH7)				
SD4694	High-speed counter ring length [Low-order] (CH7)	This register stores the high-speed counter ring length (CH7).	○	○	R/W
SD4695	High-speed counter ring length [High-order] (CH7)				
SD4696	High-speed counter measurement-unit time [Low-order] (CH7)	This register stores the high-speed counter measurement-unit time (CH7).	○	○	R/W
SD4697	High-speed counter measurement-unit time [High-order] (CH7)				
SD4698	High-speed counter number of pulses per rotation [Low-order] (CH7)	This register stores the high-speed counter number of pulses per rotation (CH7).	○	○	R/W
SD4699	High-speed counter number of pulses per rotation [High-order] (CH7)				
SD4710	High-speed counter current value [Low-order] (CH8)	This register stores the high-speed counter current value (CH8).	○	○	R/W
SD4711	High-speed counter current value [High-order] (CH8)				
SD4712	High-speed counter maximum value [Low-order] (CH8)	This register stores the high-speed counter maximum value (CH8).	○	○	R/W
SD4713	High-speed counter maximum value [High-order] (CH8)				
SD4714	High-speed counter minimum value [Low-order] (CH8)	This register stores the high-speed counter minimum value (CH8).	○	○	R/W
SD4715	High-speed counter minimum value [High-order] (CH8)				
SD4716	High-speed counter pulse density [Low-order] (CH8)	This register stores the high-speed counter pulse density (CH8).	○	○	R/W
SD4717	High-speed counter pulse density [High-order] (CH8)				
SD4718	High-speed counter rotation speed [Low-order] (CH8)	This register stores the high-speed counter rotation speed (CH8).	○	○	R/W
SD4719	High-speed counter rotation speed [High-order] (CH8)				
SD4720	High-speed counter preset control switch (CH8)	This register stores the high-speed counter preset control switch (CH8).	○	○	R/W
SD4722	High-speed counter preset value [Low-order] (CH8)	This register stores the high-speed counter preset value (CH8).	○	○	R/W
SD4723	High-speed counter preset value [High-order] (CH8)				
SD4724	High-speed counter ring length [Low-order] (CH8)	This register stores the high-speed counter ring length (CH8).	○	○	R/W
SD4725	High-speed counter ring length [High-order] (CH8)				
SD4726	High-speed counter measurement-unit time [Low-order] (CH8)	This register stores the high-speed counter measurement-unit time (CH8).	○	○	R/W
SD4727	High-speed counter measurement-unit time [High-order] (CH8)				
SD4728	High-speed counter number of pulses per rotation [Low-order] (CH8)	This register stores the high-speed counter number of pulses per rotation (CH8).	○	○	R/W
SD4729	High-speed counter number of pulses per rotation [High-order] (CH8)				
SD4740	High-speed counter current value [Low-order] (CH9)	This register stores the high-speed counter current value (CH9).	×	○	R/W
SD4741	High-speed counter current value [High-order] (CH9)				
SD4742	High-speed counter maximum value [Low-order] (CH9)	This register stores the high-speed counter maximum value (CH9).	×	○	R/W
SD4743	High-speed counter maximum value [High-order] (CH9)				
SD4744	High-speed counter minimum value [Low-order] (CH9)	This register stores the high-speed counter minimum value (CH9).	×	○	R/W
SD4745	High-speed counter minimum value [High-order] (CH9)				
SD4750	High-speed counter preset control switch (CH9)	This register stores the high-speed counter preset control switch (CH9).	×	○	R/W
SD4752	High-speed counter preset value [Low-order] (CH9)	This register stores the high-speed counter preset value (CH9).	×	○	R/W
SD4753	High-speed counter preset value [High-order] (CH9)				
SD4754	High-speed counter ring length [Low-order] (CH9)	This register stores the high-speed counter ring length (CH9).	×	○	R/W
SD4755	High-speed counter ring length [High-order] (CH9)				
SD4770	High-speed counter current value [Low-order] (CH10)	This register stores the high-speed counter current value (CH10).	×	○	R/W
SD4771	High-speed counter current value [High-order] (CH10)				
SD4772	High-speed counter maximum value [Low-order] (CH10)	This register stores the high-speed counter maximum value (CH10).	×	○	R/W
SD4773	High-speed counter maximum value [High-order] (CH10)				

No.	Name	Description	Function support		R/W
			FX5UJ	FX5U/ FX5UC	
SD4774	High-speed counter minimum value [Low-order] (CH10)	This register stores the high-speed counter minimum value (CH10).	×	○	R/W
SD4775	High-speed counter minimum value [High-order] (CH10)				
SD4780	High-speed counter preset control switch (CH10)	This register stores the high-speed counter preset control switch (CH10).	×	○	R/W
SD4782	High-speed counter preset value [Low-order] (CH10)	This register stores the high-speed counter preset value (CH10).	×	○	R/W
SD4783	High-speed counter preset value [High-order] (CH10)				
SD4784	High-speed counter ring length [Low-order] (CH10)	This register stores the high-speed counter ring length (CH10).	×	○	R/W
SD4785	High-speed counter ring length [High-order] (CH10)				
SD4800	High-speed counter current value [Low-order] (CH11)	This register stores the high-speed counter current value (CH11).	×	○	R/W
SD4801	High-speed counter current value [High-order] (CH11)				
SD4802	High-speed counter maximum value [Low-order] (CH11)	This register stores the high-speed counter maximum value (CH11).	×	○	R/W
SD4803	High-speed counter maximum value [High-order] (CH11)				
SD4804	High-speed counter minimum value [Low-order] (CH11)	This register stores the high-speed counter minimum value (CH11).	×	○	R/W
SD4805	High-speed counter minimum value [High-order] (CH11)				
SD4810	High-speed counter preset control switch (CH11)	This register stores the high-speed counter preset control switch (CH11).	×	○	R/W
SD4812	High-speed counter preset value [Low-order] (CH11)	This register stores the high-speed counter preset value (CH11).	×	○	R/W
SD4813	High-speed counter preset value [High-order] (CH11)				
SD4814	High-speed counter ring length [Low-order] (CH11)	This register stores the high-speed counter ring length (CH11).	×	○	R/W
SD4815	High-speed counter ring length [High-order] (CH11)				
SD4830	High-speed counter current value [Low-order] (CH12)	This register stores the high-speed counter current value (CH12).	×	○	R/W
SD4831	High-speed counter current value [High-order] (CH12)				
SD4832	High-speed counter maximum value [Low-order] (CH12)	This register stores the high-speed counter maximum value (CH12).	×	○	R/W
SD4833	High-speed counter maximum value [High-order] (CH12)				
SD4834	High-speed counter minimum value [Low-order] (CH12)	This register stores the high-speed counter minimum value (CH12).	×	○	R/W
SD4835	High-speed counter minimum value [High-order] (CH12)				
SD4840	High-speed counter preset control switch (CH12)	This register stores the high-speed counter preset control switch (CH12).	×	○	R/W
SD4842	High-speed counter preset value [Low-order] (CH12)	This register stores the high-speed counter preset value (CH12).	×	○	R/W
SD4843	High-speed counter preset value [High-order] (CH12)				
SD4844	High-speed counter ring length [Low-order] (CH12)	This register stores the high-speed counter ring length (CH12).	×	○	R/W
SD4845	High-speed counter ring length [High-order] (CH12)				
SD4860	High-speed counter current value [Low-order] (CH13)	This register stores the high-speed counter current value (CH13).	×	○	R/W
SD4861	High-speed counter current value [High-order] (CH13)				
SD4862	High-speed counter maximum value [Low-order] (CH13)	This register stores the high-speed counter maximum value (CH13).	×	○	R/W
SD4863	High-speed counter maximum value [High-order] (CH13)				
SD4864	High-speed counter minimum value [Low-order] (CH13)	This register stores the high-speed counter minimum value (CH13).	×	○	R/W
SD4865	High-speed counter minimum value [High-order] (CH13)				
SD4870	High-speed counter preset control switch (CH13)	This register stores the high-speed counter preset control switch (CH13).	×	○	R/W
SD4872	High-speed counter preset value [Low-order] (CH13)	This register stores the high-speed counter preset value (CH13).	×	○	R/W
SD4873	High-speed counter preset value [High-order] (CH13)				
SD4874	High-speed counter ring length [Low-order] (CH13)	This register stores the high-speed counter ring length (CH13).	×	○	R/W
SD4875	High-speed counter ring length [High-order] (CH13)				
SD4890	High-speed counter current value [Low-order] (CH14)	This register stores the high-speed counter current value (CH14).	×	○	R/W
SD4891	High-speed counter current value [High-order] (CH14)				
SD4892	High-speed counter maximum value [Low-order] (CH14)	This register stores the high-speed counter maximum value (CH14).	×	○	R/W
SD4893	High-speed counter maximum value [High-order] (CH14)				
SD4894	High-speed counter minimum value [Low-order] (CH14)	This register stores the high-speed counter minimum value (CH14).	×	○	R/W
SD4895	High-speed counter minimum value [High-order] (CH14)				
SD4900	High-speed counter preset control switch (CH14)	This register stores the high-speed counter preset control switch (CH14).	×	○	R/W

No.	Name	Description	Function support		R/W
			FX5UJ	FX5U/ FX5UC	
SD4902	High-speed counter preset value [Low-order] (CH14)	This register stores the high-speed counter preset value (CH14).	×	○	R/W
SD4903	High-speed counter preset value [High-order] (CH14)				
SD4904	High-speed counter ring length [Low-order] (CH14)	This register stores the high-speed counter ring length (CH14).	×	○	R/W
SD4905	High-speed counter ring length [High-order] (CH14)				
SD4920	High-speed counter current value [Low-order] (CH15)	This register stores the high-speed counter current value (CH15).	×	○	R/W
SD4921	High-speed counter current value [High-order] (CH15)				
SD4922	High-speed counter maximum value [Low-order] (CH15)	This register stores the high-speed counter maximum value (CH15).	×	○	R/W
SD4923	High-speed counter maximum value [High-order] (CH15)				
SD4924	High-speed counter minimum value [Low-order] (CH15)	This register stores the high-speed counter minimum value (CH15).	×	○	R/W
SD4925	High-speed counter minimum value [High-order] (CH15)				
SD4930	High-speed counter preset control switch (CH15)	This register stores the high-speed counter preset control switch (CH15).	×	○	R/W
SD4932	High-speed counter preset value [Low-order] (CH15)	This register stores the high-speed counter preset value (CH15).	×	○	R/W
SD4933	High-speed counter preset value [High-order] (CH15)				
SD4934	High-speed counter ring length [Low-order] (CH15)	This register stores the high-speed counter ring length (CH15).	×	○	R/W
SD4935	High-speed counter ring length [High-order] (CH15)				
SD4950	High-speed counter current value [Low-order] (CH16)	This register stores the high-speed counter current value (CH16).	×	○	R/W
SD4951	High-speed counter current value [High-order] (CH16)				
SD4952	High-speed counter maximum value [Low-order] (CH16)	This register stores the high-speed counter maximum value (CH16).	×	○	R/W
SD4953	High-speed counter maximum value [High-order] (CH16)				
SD4954	High-speed counter minimum value [Low-order] (CH16)	This register stores the high-speed counter minimum value (CH16).	×	○	R/W
SD4955	High-speed counter minimum value [High-order] (CH16)				
SD4960	High-speed counter preset control switch (CH16)	This register stores the high-speed counter preset control switch (CH16).	×	○	R/W
SD4962	High-speed counter preset value [Low-order] (CH16)	This register stores the high-speed counter preset value (CH16).	×	○	R/W
SD4963	High-speed counter preset value [High-order] (CH16)				
SD4964	High-speed counter ring length [Low-order] (CH16)	This register stores the high-speed counter ring length (CH16).	×	○	R/W
SD4965	High-speed counter ring length [High-order] (CH16)				
SD4982	High-speed comparison table (high-speed compare instruction) error code (CPU module)	This register stores the high-speed comparison table (high-speed compare instruction) error code.	○	○	R/W
SD4986	High-speed comparison table error code (high-speed pulse input/output module first module)		×	○	
SD4990	High-speed comparison table error code (high-speed pulse input/output module second module)		×	○	
SD4994	High-speed comparison table error code (high-speed pulse input/output module third module)		×	○	
SD4998	High-speed comparison table error code (high-speed pulse input/output module fourth module)		×	○	
SD5000	Multi-point output high-speed comparison table comparison number	This register stores the multi-point output high-speed comparison table comparison number.	○	○	R
SD5020	Pulse width measurement rising ring counter value [Low-order] (CH1)	This register stores the pulse width measurement rising ring counter value (CH1).	○	○	R
SD5021	Pulse width measurement rising ring counter value [High-order] (CH1)				
SD5022	Pulse width measurement falling ring counter value [Low-order] (CH1)	This register stores the pulse width measurement falling ring counter value (CH1).	○	○	R
SD5023	Pulse width measurement falling ring counter value [High-order] (CH1)				
SD5024	Pulse width measurement latest value [Low-order] (CH1)	This register stores the pulse width measurement latest value (CH1).	○	○	R
SD5025	Pulse width measurement latest value [High-order] (CH1)				
SD5026	Pulse width measurement maximum value [Low-order] (CH1)	This register stores the pulse width measurement maximum value (CH1).	○	○	R/W
SD5027	Pulse width measurement maximum value [High-order] (CH1)				

No.	Name	Description	Function support		R/W
			FX5UJ	FX5U/ FX5UC	
SD5028	Pulse width measurement minimum value [Low-order] (CH1)	This register stores the pulse width measurement minimum value (CH1).	○	○	R/W
SD5029	Pulse width measurement minimum value [High-order] (CH1)				
SD5030	Pulse width measurement cycle latest value [Low-order] (CH1)	This register stores the pulse width measurement cycle latest value (CH1).	○	○	R
SD5031	Pulse width measurement cycle latest value [High-order] (CH1)				
SD5032	Pulse width measurement cycle maximum value [Low-order] (CH1)	This register stores the pulse width measurement cycle maximum value (CH1).	○	○	R/W
SD5033	Pulse width measurement cycle maximum value [High-order] (CH1)				
SD5034	Pulse width measurement cycle minimum value [Low-order] (CH1)	This register stores the pulse width measurement cycle minimum value (CH1).	○	○	R/W
SD5035	Pulse width measurement cycle minimum value [High-order] (CH1)				
SD5040	Pulse width measurement rising ring counter value [Low-order] (CH2)	This register stores the pulse width measurement rising ring counter value (CH2).	○	○	R
SD5041	Pulse width measurement rising ring counter value [High-order] (CH2)				
SD5042	Pulse width measurement falling ring counter value [Low-order] (CH2)	This register stores the pulse width measurement falling ring counter value (CH2).	○	○	R
SD5043	Pulse width measurement falling ring counter value [High-order] (CH2)				
SD5044	Pulse width measurement latest value [Low-order] (CH2)	This register stores the pulse width measurement latest value (CH2).	○	○	R
SD5045	Pulse width measurement latest value [High-order] (CH2)				
SD5046	Pulse width measurement maximum value [Low-order] (CH2)	This register stores the pulse width measurement maximum value (CH2).	○	○	R/W
SD5047	Pulse width measurement maximum value [High-order] (CH2)				
SD5048	Pulse width measurement minimum value [Low-order] (CH2)	This register stores the pulse width measurement minimum value (CH2).	○	○	R/W
SD5049	Pulse width measurement minimum value [High-order] (CH2)				
SD5050	Pulse width measurement cycle latest value [Low-order] (CH2)	This register stores the pulse width measurement cycle latest value (CH2).	○	○	R
SD5051	Pulse width measurement cycle latest value [High-order] (CH2)				
SD5052	Pulse width measurement cycle maximum value [Low-order] (CH2)	This register stores the pulse width measurement cycle maximum value (CH2).	○	○	R/W
SD5053	Pulse width measurement cycle maximum value [High-order] (CH2)				
SD5054	Pulse width measurement cycle minimum value [Low-order] (CH2)	This register stores the pulse width measurement cycle minimum value (CH2).	○	○	R/W
SD5055	Pulse width measurement cycle minimum value [High-order] (CH2)				
SD5060	Pulse width measurement rising ring counter value [Low-order] (CH3)	This register stores the pulse width measurement rising ring counter value (CH3).	○	○	R
SD5061	Pulse width measurement rising ring counter value [High-order] (CH3)				
SD5062	Pulse width measurement falling ring counter value [Low-order] (CH3)	This register stores the pulse width measurement falling ring counter value (CH3).	○	○	R
SD5063	Pulse width measurement falling ring counter value [High-order] (CH3)				
SD5064	Pulse width measurement latest value [Low-order] (CH3)	This register stores the pulse width measurement latest value (CH3).	○	○	R
SD5065	Pulse width measurement latest value [High-order] (CH3)				
SD5066	Pulse width measurement maximum value [Low-order] (CH3)	This register stores the pulse width measurement maximum value (CH3).	○	○	R/W
SD5067	Pulse width measurement maximum value [High-order] (CH3)				
SD5068	Pulse width measurement minimum value [Low-order] (CH3)	This register stores the pulse width measurement minimum value (CH3).	○	○	R/W
SD5069	Pulse width measurement minimum value [High-order] (CH3)				
SD5070	Pulse width measurement cycle latest value [Low-order] (CH3)	This register stores the pulse width measurement cycle latest value (CH3).	○	○	R
SD5071	Pulse width measurement cycle latest value [High-order] (CH3)				
SD5072	Pulse width measurement cycle maximum value [Low-order] (CH3)	This register stores the pulse width measurement cycle maximum value (CH3).	○	○	R/W
SD5073	Pulse width measurement cycle maximum value [High-order] (CH3)				

No.	Name	Description	Function support		R/W
			FX5UJ	FX5U/ FX5UC	
SD5074	Pulse width measurement cycle minimum value [Low-order] (CH3)	This register stores the pulse width measurement cycle minimum value (CH3).	○	○	R/W
SD5075	Pulse width measurement cycle minimum value [High-order] (CH3)				
SD5080	Pulse width measurement rising ring counter value [Low-order] (CH4)	This register stores the pulse width measurement rising ring counter value (CH4).	○	○	R
SD5081	Pulse width measurement rising ring counter value [High-order] (CH4)				
SD5082	Pulse width measurement falling ring counter value [Low-order] (CH4)	This register stores the pulse width measurement falling ring counter value (CH4).	○	○	R
SD5083	Pulse width measurement falling ring counter value [High-order] (CH4)				
SD5084	Pulse width measurement latest value [Low-order] (CH4)	This register stores the pulse width measurement latest value (CH4).	○	○	R
SD5085	Pulse width measurement latest value [High-order] (CH4)				
SD5086	Pulse width measurement maximum value [Low-order] (CH4)	This register stores the pulse width measurement maximum value (CH4).	○	○	R/W
SD5087	Pulse width measurement maximum value [High-order] (CH4)				
SD5088	Pulse width measurement minimum value [Low-order] (CH4)	This register stores the pulse width measurement minimum value (CH4).	○	○	R/W
SD5089	Pulse width measurement minimum value [High-order] (CH4)				
SD5090	Pulse width measurement cycle latest value [Low-order] (CH4)	This register stores the pulse width measurement cycle latest value (CH4).	○	○	R
SD5091	Pulse width measurement cycle latest value [High-order] (CH4)				
SD5092	Pulse width measurement cycle maximum value [Low-order] (CH4)	This register stores the pulse width measurement cycle maximum value (CH4).	○	○	R/W
SD5093	Pulse width measurement cycle maximum value [High-order] (CH4)				
SD5094	Pulse width measurement cycle minimum value [Low-order] (CH4)	This register stores the pulse width measurement cycle minimum value (CH4).	○	○	R/W
SD5095	Pulse width measurement cycle minimum value [High-order] (CH4)				
SD5100	Pulse width measurement rising ring counter value [Low-order] (CH5)	This register stores the pulse width measurement rising ring counter value (CH5).	×	○	R
SD5101	Pulse width measurement rising ring counter value [High-order] (CH5)				
SD5102	Pulse width measurement falling ring counter value [Low-order] (CH5)	This register stores the pulse width measurement falling ring counter value (CH5).	×	○	R
SD5103	Pulse width measurement falling ring counter value [High-order] (CH5)				
SD5104	Pulse width measurement latest value [Low-order] (CH5)	This register stores the pulse width measurement latest value (CH5).	×	○	R
SD5105	Pulse width measurement latest value [High-order] (CH5)				
SD5106	Pulse width measurement maximum value [Low-order] (CH5)	This register stores the pulse width measurement maximum value (CH5).	×	○	R/W
SD5107	Pulse width measurement maximum value [High-order] (CH5)				
SD5108	Pulse width measurement minimum value [Low-order] (CH5)	This register stores the pulse width measurement minimum value (CH5).	×	○	R/W
SD5109	Pulse width measurement minimum value [High-order] (CH5)				
SD5110	Pulse width measurement cycle latest value [Low-order] (CH5)	This register stores the pulse width measurement cycle latest value (CH5).	×	○	R
SD5111	Pulse width measurement cycle latest value [High-order] (CH5)				
SD5112	Pulse width measurement cycle maximum value [Low-order] (CH5)	This register stores the pulse width measurement cycle maximum value (CH5).	×	○	R/W
SD5113	Pulse width measurement cycle maximum value [High-order] (CH5)				
SD5114	Pulse width measurement cycle minimum value [Low-order] (CH5)	This register stores the pulse width measurement cycle minimum value (CH5).	×	○	R/W
SD5115	Pulse width measurement cycle minimum value [High-order] (CH5)				
SD5120	Pulse width measurement rising ring counter value [Low-order] (CH6)	This register stores the pulse width measurement rising ring counter value (CH6).	×	○	R
SD5121	Pulse width measurement rising ring counter value [High-order] (CH6)				

No.	Name	Description	Function support		R/W
			FX5UJ	FX5U/ FX5UC	
SD5122	Pulse width measurement falling ring counter value [Low-order] (CH6)	This register stores the pulse width measurement falling ring counter value (CH6).	×	○	R
SD5123	Pulse width measurement falling ring counter value [High-order] (CH6)				
SD5124	Pulse width measurement latest value [Low-order] (CH6)	This register stores the pulse width measurement latest value (CH6).	×	○	R
SD5125	Pulse width measurement latest value [High-order] (CH6)				
SD5126	Pulse width measurement maximum value [Low-order] (CH6)	This register stores the pulse width measurement maximum value (CH6).	×	○	R/W
SD5127	Pulse width measurement maximum value [High-order] (CH6)				
SD5128	Pulse width measurement minimum value [Low-order] (CH6)	This register stores the pulse width measurement minimum value (CH6).	×	○	R/W
SD5129	Pulse width measurement minimum value [High-order] (CH6)				
SD5130	Pulse width measurement cycle latest value [Low-order] (CH6)	This register stores the pulse width measurement cycle latest value (CH6).	×	○	R
SD5131	Pulse width measurement cycle latest value [High-order] (CH6)				
SD5132	Pulse width measurement cycle maximum value [Low-order] (CH6)	This register stores the pulse width measurement cycle maximum value (CH6).	×	○	R/W
SD5133	Pulse width measurement cycle maximum value [High-order] (CH6)				
SD5134	Pulse width measurement cycle minimum value [Low-order] (CH6)	This register stores the pulse width measurement cycle minimum value (CH6).	×	○	R/W
SD5135	Pulse width measurement cycle minimum value [High-order] (CH6)				
SD5140	Pulse width measurement rising ring counter value [Low-order] (CH7)	This register stores the pulse width measurement rising ring counter value (CH7).	×	○	R
SD5141	Pulse width measurement rising ring counter value [High-order] (CH7)				
SD5142	Pulse width measurement falling ring counter value [Low-order] (CH7)	This register stores the pulse width measurement falling ring counter value (CH7).	×	○	R
SD5143	Pulse width measurement falling ring counter value [High-order] (CH7)				
SD5144	Pulse width measurement latest value [Low-order] (CH7)	This register stores the pulse width measurement latest value (CH7).	×	○	R
SD5145	Pulse width measurement latest value [High-order] (CH7)				
SD5146	Pulse width measurement maximum value [Low-order] (CH7)	This register stores the pulse width measurement maximum value (CH7).	×	○	R/W
SD5147	Pulse width measurement maximum value [High-order] (CH7)				
SD5148	Pulse width measurement minimum value [Low-order] (CH7)	This register stores the pulse width measurement minimum value (CH7).	×	○	R/W
SD5149	Pulse width measurement minimum value [High-order] (CH7)				
SD5150	Pulse width measurement cycle latest value [Low-order] (CH7)	This register stores the pulse width measurement cycle latest value (CH7).	×	○	R
SD5151	Pulse width measurement cycle latest value [High-order] (CH7)				
SD5152	Pulse width measurement cycle maximum value [Low-order] (CH7)	This register stores the pulse width measurement cycle maximum value (CH7).	×	○	R/W
SD5153	Pulse width measurement cycle maximum value [High-order] (CH7)				
SD5154	Pulse width measurement cycle minimum value [Low-order] (CH7)	This register stores the pulse width measurement cycle minimum value (CH7).	×	○	R/W
SD5155	Pulse width measurement cycle minimum value [High-order] (CH7)				
SD5160	Pulse width measurement rising ring counter value [Low-order] (CH8)	This register stores the pulse width measurement rising ring counter value (CH8).	×	○	R
SD5161	Pulse width measurement rising ring counter value [High-order] (CH8)				
SD5162	Pulse width measurement falling ring counter value [Low-order] (CH8)	This register stores the pulse width measurement falling ring counter value (CH8).	×	○	R
SD5163	Pulse width measurement falling ring counter value [High-order] (CH8)				
SD5164	Pulse width measurement latest value [Low-order] (CH8)	This register stores the pulse width measurement latest value (CH8).	×	○	R
SD5165	Pulse width measurement latest value [High-order] (CH8)				
SD5166	Pulse width measurement maximum value [Low-order] (CH8)	This register stores the pulse width measurement maximum value (CH8).	×	○	R/W
SD5167	Pulse width measurement maximum value [High-order] (CH8)				

No.	Name	Description	Function support		R/W
			FX5UJ	FX5U/ FX5UC	
SD5168	Pulse width measurement minimum value [Low-order] (CH8)	This register stores the pulse width measurement minimum value (CH8).	×	○	R/W
SD5169	Pulse width measurement minimum value [High-order] (CH8)				
SD5170	Pulse width measurement cycle latest value [Low-order] (CH8)	This register stores the pulse width measurement cycle latest value (CH8).	×	○	R
SD5171	Pulse width measurement cycle latest value [High-order] (CH8)				
SD5172	Pulse width measurement cycle maximum value [Low-order] (CH8)	This register stores the pulse width measurement cycle maximum value (CH8).	×	○	R/W
SD5173	Pulse width measurement cycle maximum value [High-order] (CH8)				
SD5174	Pulse width measurement cycle minimum value [Low-order] (CH8)	This register stores the pulse width measurement cycle minimum value (CH8).	×	○	R/W
SD5175	Pulse width measurement cycle minimum value [High-order] (CH8)				
SD5180	Pulse width measurement rising ring counter value [Low-order] (CH9)	This register stores the pulse width measurement rising ring counter value (CH9).	×	○	R
SD5181	Pulse width measurement rising ring counter value [High-order] (CH9)				
SD5182	Pulse width measurement falling ring counter value [Low-order] (CH9)	This register stores the pulse width measurement falling ring counter value (CH9).	×	○	R
SD5183	Pulse width measurement falling ring counter value [High-order] (CH9)				
SD5184	Pulse width measurement latest value [Low-order] (CH9)	This register stores the pulse width measurement latest value (CH9).	×	○	R
SD5185	Pulse width measurement latest value [High-order] (CH9)				
SD5186	Pulse width measurement maximum value [Low-order] (CH9)	This register stores the pulse width measurement maximum value (CH9).	×	○	R/W
SD5187	Pulse width measurement maximum value [High-order] (CH9)				
SD5188	Pulse width measurement minimum value [Low-order] (CH9)	This register stores the pulse width measurement minimum value (CH9).	×	○	R/W
SD5189	Pulse width measurement minimum value [High-order] (CH9)				
SD5190	Pulse width measurement cycle latest value [Low-order] (CH9)	This register stores the pulse width measurement cycle latest value (CH9).	×	○	R
SD5191	Pulse width measurement cycle latest value [High-order] (CH9)				
SD5192	Pulse width measurement cycle maximum value [Low-order] (CH9)	This register stores the pulse width measurement cycle maximum value (CH9).	×	○	R/W
SD5193	Pulse width measurement cycle maximum value [High-order] (CH9)				
SD5194	Pulse width measurement cycle minimum value [Low-order] (CH9)	This register stores the pulse width measurement cycle minimum value (CH9).	×	○	R/W
SD5195	Pulse width measurement cycle minimum value [High-order] (CH9)				
SD5200	Pulse width measurement rising ring counter value [Low-order] (CH10)	This register stores the pulse width measurement rising ring counter value (CH10).	×	○	R
SD5201	Pulse width measurement rising ring counter value [High-order] (CH10)				
SD5202	Pulse width measurement falling ring counter value [Low-order] (CH10)	This register stores the pulse width measurement falling ring counter value (CH10).	×	○	R
SD5203	Pulse width measurement falling ring counter value [High-order] (CH10)				
SD5204	Pulse width measurement latest value [Low-order] (CH10)	This register stores the pulse width measurement latest value (CH10).	×	○	R
SD5205	Pulse width measurement latest value [High-order] (CH10)				
SD5206	Pulse width measurement maximum value [Low-order] (CH10)	This register stores the pulse width measurement maximum value (CH10).	×	○	R/W
SD5207	Pulse width measurement maximum value [High-order] (CH10)				
SD5208	Pulse width measurement minimum value [Low-order] (CH10)	This register stores the pulse width measurement minimum value (CH10).	×	○	R/W
SD5209	Pulse width measurement minimum value [High-order] (CH10)				
SD5210	Pulse width measurement cycle latest value [Low-order] (CH10)	This register stores the pulse width measurement cycle latest value (CH10).	×	○	R
SD5211	Pulse width measurement cycle latest value [High-order] (CH10)				
SD5212	Pulse width measurement cycle maximum value [Low-order] (CH10)	This register stores the pulse width measurement cycle maximum value (CH10).	×	○	R/W
SD5213	Pulse width measurement cycle maximum value [High-order] (CH10)				

No.	Name	Description	Function support		R/W
			FX5UJ	FX5U/ FX5UC	
SD5214	Pulse width measurement cycle minimum value [Low-order] (CH10)	This register stores the pulse width measurement cycle minimum value (CH10).	×	○	R/W
SD5215	Pulse width measurement cycle minimum value [High-order] (CH10)				
SD5220	Pulse width measurement rising ring counter value [Low-order] (CH11)	This register stores the pulse width measurement rising ring counter value (CH11).	×	○	R
SD5221	Pulse width measurement rising ring counter value [High-order] (CH11)				
SD5222	Pulse width measurement falling ring counter value [Low-order] (CH11)	This register stores the pulse width measurement falling ring counter value (CH11).	×	○	R
SD5223	Pulse width measurement falling ring counter value [High-order] (CH11)				
SD5224	Pulse width measurement latest value [Low-order] (CH11)	This register stores the pulse width measurement latest value (CH11).	×	○	R
SD5225	Pulse width measurement latest value [High-order] (CH11)				
SD5226	Pulse width measurement maximum value [Low-order] (CH11)	This register stores the pulse width measurement maximum value (CH11).	×	○	R/W
SD5227	Pulse width measurement maximum value [High-order] (CH11)				
SD5228	Pulse width measurement minimum value [Low-order] (CH11)	This register stores the pulse width measurement minimum value (CH11).	×	○	R/W
SD5229	Pulse width measurement minimum value [High-order] (CH11)				
SD5230	Pulse width measurement cycle latest value [Low-order] (CH11)	This register stores the pulse width measurement cycle latest value (CH11).	×	○	R
SD5231	Pulse width measurement cycle latest value [High-order] (CH11)				
SD5232	Pulse width measurement cycle maximum value [Low-order] (CH11)	This register stores the pulse width measurement cycle maximum value (CH11).	×	○	R/W
SD5233	Pulse width measurement cycle maximum value [High-order] (CH11)				
SD5234	Pulse width measurement cycle minimum value [Low-order] (CH11)	This register stores the pulse width measurement cycle minimum value (CH11).	×	○	R/W
SD5235	Pulse width measurement cycle minimum value [High-order] (CH11)				
SD5240	Pulse width measurement rising ring counter value [Low-order] (CH12)	This register stores the pulse width measurement rising ring counter value (CH12).	×	○	R
SD5241	Pulse width measurement rising ring counter value [High-order] (CH12)				
SD5242	Pulse width measurement falling ring counter value [Low-order] (CH12)	This register stores the pulse width measurement falling ring counter value (CH12).	×	○	R
SD5243	Pulse width measurement falling ring counter value [High-order] (CH12)				
SD5244	Pulse width measurement latest value [Low-order] (CH12)	This register stores the pulse width measurement latest value (CH12).	×	○	R
SD5245	Pulse width measurement latest value [High-order] (CH12)				
SD5246	Pulse width measurement maximum value [Low-order] (CH12)	This register stores the pulse width measurement maximum value (CH12).	×	○	R/W
SD5247	Pulse width measurement maximum value [High-order] (CH12)				
SD5248	Pulse width measurement minimum value [Low-order] (CH12)	This register stores the pulse width measurement minimum value (CH12).	×	○	R/W
SD5249	Pulse width measurement minimum value [High-order] (CH12)				
SD5250	Pulse width measurement cycle latest value [Low-order] (CH12)	This register stores the pulse width measurement cycle latest value (CH12).	×	○	R
SD5251	Pulse width measurement cycle latest value [High-order] (CH12)				
SD5252	Pulse width measurement cycle maximum value [Low-order] (CH12)	This register stores the pulse width measurement cycle maximum value (CH12).	×	○	R/W
SD5253	Pulse width measurement cycle maximum value [High-order] (CH12)				
SD5254	Pulse width measurement cycle minimum value [Low-order] (CH12)	This register stores the pulse width measurement cycle minimum value (CH12).	×	○	R/W
SD5255	Pulse width measurement cycle minimum value [High-order] (CH12)				
SD5300	PWM pulse output number [Low-order] (CH1)	This register stores the PWM pulse output number (CH1).	○	○	R/W
SD5301	PWM pulse output number [High-order] (CH1)				
SD5302	PWM pulse width [Low-order] (CH1)	This register stores the PWM pulse width (CH1).	○	○	R/W
SD5303	PWM pulse width [High-order] (CH1)				

No.	Name	Description	Function support		R/W
			FX5UJ	FX5U/ FX5UC	
SD5304	PWM cycle [Low-order] (CH1)	This register stores the PWM cycle (CH1).	○	○	R/W
SD5305	PWM cycle [High-order] (CH1)				
SD5306	PWM Number of output pulses current value monitor [Low-order] (CH1)	This register stores the PWM pulse output number current value (CH1).	○	○	R
SD5307	PWM Number of output pulses current value monitor [High-order] (CH1)				
SD5316	PWM pulse output number [Low-order] (CH2)	This register stores the PWM pulse output number (CH2).	○	○	R/W
SD5317	PWM pulse output number [High-order] (CH2)				
SD5318	PWM pulse width [Low-order] (CH2)	This register stores the PWM pulse width (CH2).	○	○	R/W
SD5319	PWM pulse width [High-order] (CH2)				
SD5320	PWM cycle [Low-order] (CH2)	This register stores the PWM cycle (CH2).	○	○	R/W
SD5321	PWM cycle [High-order] (CH2)				
SD5322	PWM Number of output pulses current value monitor [Low-order] (CH2)	This register stores the PWM pulse output number current value (CH2).	○	○	R
SD5323	PWM Number of output pulses current value monitor [High-order] (CH2)				
SD5332	PWM pulse output number [Low-order] (CH3)	This register stores the PWM pulse output number (CH3).	○	○	R/W
SD5333	PWM pulse output number [High-order] (CH3)				
SD5334	PWM pulse width [Low-order] (CH3)	This register stores the PWM pulse width (CH3).	○	○	R/W
SD5335	PWM pulse width [High-order] (CH3)				
SD5336	PWM cycle [Low-order] (CH3)	This register stores the PWM cycle (CH3).	○	○	R/W
SD5337	PWM cycle [High-order] (CH3)				
SD5338	PWM Number of output pulses current value monitor [Low-order] (CH3)	This register stores the PWM pulse output number current value (CH3).	○	○	R
SD5339	PWM Number of output pulses current value monitor [High-order] (CH3)				
SD5348	PWM pulse output number [Low-order] (CH4)	This register stores the PWM pulse output number (CH4).	○	○	R/W
SD5349	PWM pulse output number [High-order] (CH4)				
SD5350	PWM pulse width [Low-order] (CH4)	This register stores the PWM pulse width (CH4).	○	○	R/W
SD5351	PWM pulse width [High-order] (CH4)				
SD5352	PWM cycle [Low-order] (CH4)	This register stores the PWM cycle (CH4).	○	○	R/W
SD5353	PWM cycle [High-order] (CH4)				
SD5354	PWM Number of output pulses current value monitor [Low-order] (CH4)	This register stores the PWM pulse output number current value (CH4).	○	○	R
SD5355	PWM Number of output pulses current value monitor [High-order] (CH4)				
SD5364	PWM pulse output number [Low-order] (CH5)	This register stores the PWM pulse output number (CH5).	×	○	R/W
SD5365	PWM pulse output number [High-order] (CH5)				
SD5366	PWM pulse width [Low-order] (CH5)	This register stores the PWM pulse width (CH5).	×	○	R/W
SD5367	PWM pulse width [High-order] (CH5)				
SD5368	PWM cycle [Low-order] (CH5)	This register stores the PWM cycle (CH5).	×	○	R/W
SD5369	PWM cycle [High-order] (CH5)				
SD5380	PWM pulse output number [Low-order] (CH6)	This register stores the PWM pulse output number (CH6).	×	○	R/W
SD5381	PWM pulse output number [High-order] (CH6)				
SD5382	PWM pulse width [Low-order] (CH6)	This register stores the PWM pulse width (CH6).	×	○	R/W
SD5383	PWM pulse width [High-order] (CH6)				
SD5384	PWM cycle [Low-order] (CH6)	This register stores the PWM cycle (CH6).	×	○	R/W
SD5385	PWM cycle [High-order] (CH6)				
SD5396	PWM pulse output number [Low-order] (CH7)	This register stores the PWM pulse output number (CH7).	×	○	R/W
SD5397	PWM pulse output number [High-order] (CH7)				
SD5398	PWM pulse width [Low-order] (CH7)	This register stores the PWM pulse width (CH7).	×	○	R/W
SD5399	PWM pulse width [High-order] (CH7)				

No.	Name	Description	Function support		R/W
			FX5UJ	FX5U/ FX5UC	
SD5400	PWM cycle [Low-order] (CH7)	This register stores the PWM cycle (CH7).	×	○	R/W
SD5401	PWM cycle [High-order] (CH7)				
SD5412	PWM pulse output number [Low-order] (CH8)	This register stores the PWM pulse output number (CH8).	×	○	R/W
SD5413	PWM pulse output number [High-order] (CH8)				
SD5414	PWM pulse width [Low-order] (CH8)	This register stores the PWM pulse width (CH8).	×	○	R/W
SD5415	PWM pulse width [High-order] (CH8)				
SD5416	PWM cycle [Low-order] (CH8)	This register stores the PWM cycle (CH8).	×	○	R/W
SD5417	PWM cycle [High-order] (CH8)				
SD5428	PWM pulse output number [Low-order] (CH9)	This register stores the PWM pulse output number (CH9).	×	○	R/W
SD5429	PWM pulse output number [High-order] (CH9)				
SD5430	PWM pulse width [Low-order] (CH9)	This register stores the PWM pulse width (CH9).	×	○	R/W
SD5431	PWM pulse width [High-order] (CH9)				
SD5432	PWM cycle [Low-order] (CH9)	This register stores the PWM cycle (CH9).	×	○	R/W
SD5433	PWM cycle [High-order] (CH9)				
SD5444	PWM pulse output number [Low-order] (CH10)	This register stores the PWM pulse output number (CH10).	×	○	R/W
SD5445	PWM pulse output number [High-order] (CH10)				
SD5446	PWM pulse width [Low-order] (CH10)	This register stores the PWM pulse width (CH10).	×	○	R/W
SD5447	PWM pulse width [High-order] (CH10)				
SD5448	PWM cycle [Low-order] (CH10)	This register stores the PWM cycle (CH10).	×	○	R/W
SD5449	PWM cycle [High-order] (CH10)				
SD5460	PWM pulse output number [Low-order] (CH11)	This register stores the PWM pulse output number (CH11).	×	○	R/W
SD5461	PWM pulse output number [High-order] (CH11)				
SD5462	PWM pulse width [Low-order] (CH11)	This register stores the PWM pulse width (CH11).	×	○	R/W
SD5463	PWM pulse width [High-order] (CH11)				
SD5464	PWM cycle [Low-order] (CH11)	This register stores the PWM cycle (CH11).	×	○	R/W
SD5465	PWM cycle [High-order] (CH11)				
SD5476	PWM pulse output number [Low-order] (CH12)	This register stores the PWM pulse output number (CH12).	×	○	R/W
SD5477	PWM pulse output number [High-order] (CH12)				
SD5478	PWM pulse width [Low-order] (CH12)	This register stores the PWM pulse width (CH12).	×	○	R/W
SD5479	PWM pulse width [High-order] (CH12)				
SD5480	PWM cycle [Low-order] (CH12)	This register stores the PWM cycle (CH12).	×	○	R/W
SD5481	PWM cycle [High-order] (CH12)				
SD5500	Positioning current address (user unit) [Low-order] (axis 1)	This register stores the current address (user unit) of positioning (axis 1).	○	○	R/W
SD5501	Positioning current address (user unit) [High-order] (axis 1)				
SD5502	Positioning current address (pulse unit) [Low-order] (axis 1)	This register stores the current address (pulse unit) of positioning (axis 1).	○	○	R/W
SD5503	Positioning current address (pulse unit) [High-order] (axis 1)				
SD5504	Positioning current speed (user unit) [Low-order] (axis 1)	This register stores the current speed (user unit) of positioning (axis 1).	○	○	R
SD5505	Positioning current speed (user unit) [High-order] (axis 1)				
SD5506	Positioning execution table number (axis 1)	This register stores the execution table number of positioning (axis 1).	○	○	R
SD5510	Positioning error code (axis 1)	This register stores the error code of positioning (axis 1).	○	○	R/W
SD5511	Positioning error table number (axis 1)	This register stores the error table number of positioning (axis 1).	○	○	R/W
SD5516	Positioning maximum speed [Low-order] (axis 1)	This register stores the maximum speed of positioning (axis 1).	○	○	R/W
SD5517	Positioning maximum speed [High-order] (axis 1)				
SD5518	Positioning bias speed [Low-order] (axis 1)	This register stores the bias speed of positioning (axis 1).	○	○	R/W
SD5519	Positioning bias speed [High-order] (axis 1)				
SD5520	Positioning acceleration time (axis 1)	This register stores the acceleration time of positioning (axis 1).	○	○	R/W
SD5521	Positioning deceleration time (axis 1)	This register stores the deceleration time of positioning (axis 1).	○	○	R/W

No.	Name	Description	Function support		R/W
			FX5UJ	FX5U/ FX5UC	
SD5526	Positioning zero-return speed [Low-order] (axis 1)	This register stores the zero-return speed of positioning (axis 1).	○	○	R/W
SD5527	Positioning zero-return speed [High-order] (axis 1)				
SD5528	Positioning creep speed [Low-order] (axis 1)	This register stores the creep speed of positioning (axis 1).	○	○	R/W
SD5529	Positioning creep speed [High-order] (axis 1)				
SD5530	Positioning zero-point address [Low-order] (axis 1)	This register stores the zero-point address of positioning (axis 1).	○	○	R/W
SD5531	Positioning zero-point address [High-order] (axis 1)				
SD5532	Positioning number of zero-point signal for zero return	This register stores the number of zero-point signal for zero return of positioning (axis 1).	○	○	R/W
SD5533	Positioning zero-return dwell time (axis 1)	This register stores the zero-return dwell time of positioning (axis 1).	○	○	R/W
SD5540	Positioning current address (user unit) [Low-order] (axis 2)	This register stores the current address (user unit) of positioning (axis 2).	○	○	R/W
SD5541	Positioning current address (user unit) [High-order] (axis 2)				
SD5542	Positioning current address (pulse unit) [Low-order] (axis 2)	This register stores the current address (pulse unit) of positioning (axis 2).	○	○	R/W
SD5543	Positioning current address (pulse unit) [High-order] (axis 2)				
SD5544	Positioning current speed (user unit) [Low-order] (axis 2)	This register stores the current speed (user unit) of positioning (axis 2).	○	○	R
SD5545	Positioning current speed (user unit) [High-order] (axis 2)				
SD5546	Positioning execution table number (axis 2)	This register stores the execution table number of positioning (axis 2).	○	○	R
SD5550	Positioning error code (axis 2)	This register stores the error code of positioning (axis 2).	○	○	R/W
SD5551	Positioning error table number (axis 2)	This register stores the error table number of positioning (axis 2).	○	○	R/W
SD5556	Positioning maximum speed [Low-order] (axis 2)	This register stores the maximum speed of positioning (axis 2).	○	○	R/W
SD5557	Positioning maximum speed [High-order] (axis 2)				
SD5558	Positioning bias speed [Low-order] (axis 2)	This register stores the bias speed of positioning (axis 2).	○	○	R/W
SD5559	Positioning bias speed [High-order] (axis 2)				
SD5560	Positioning acceleration time (axis 2)	This register stores the acceleration time of positioning (axis 2).	○	○	R/W
SD5561	Positioning deceleration time (axis 2)	This register stores the deceleration time of positioning (axis 2).	○	○	R/W
SD5566	Positioning zero-return speed [Low-order] (axis 2)	This register stores the zero-return speed of positioning (axis 2).	○	○	R/W
SD5567	Positioning zero-return speed [High-order] (axis 2)				
SD5568	Positioning creep speed [Low-order] (axis 2)	This register stores the creep speed of positioning (axis 2).	○	○	R/W
SD5569	Positioning creep speed [High-order] (axis 2)				
SD5570	Positioning zero-point address [Low-order] (axis 2)	This register stores the zero-point address of positioning (axis 2).	○	○	R/W
SD5571	Positioning zero-point address [High-order] (axis 2)				
SD5572	Positioning number of zero-point signal for zero return (axis 2)	This register stores the number of zero-point signal for zero return of positioning (axis 2).	○	○	R/W
SD5573	Positioning zero-return dwell time (axis 2)	This register stores the zero-return dwell time of positioning (axis 2).	○	○	R/W
SD5580	Positioning current address (user unit) [Low-order] (axis 3)	This register stores the current address (user unit) of positioning (axis 3).	○	○	R/W
SD5581	Positioning current address (user unit) [High-order] (axis 3)				
SD5582	Positioning current address (pulse unit) [Low-order] (axis 3)	This register stores the current address (pulse unit) of positioning (axis 3).	○	○	R/W
SD5583	Positioning current address (pulse unit) [High-order] (axis 3)				
SD5584	Positioning current speed (user unit) [Low-order] (axis 3)	This register stores the current speed (user unit) of positioning (axis 3).	○	○	R
SD5585	Positioning current speed (user unit) [High-order] (axis 3)				
SD5586	Positioning execution table number (axis 3)	This register stores the execution table number of positioning (axis 3).	○	○	R
SD5590	Positioning error code (axis 3)	This register stores the error code of positioning (axis 3).	○	○	R/W
SD5591	Positioning error table number (axis 3)	This register stores the error table number of positioning (axis 3).	○	○	R/W
SD5596	Positioning maximum speed [Low-order] (axis 3)	This register stores the maximum speed of positioning (axis 3).	○	○	R/W
SD5597	Positioning maximum speed [High-order] (axis 3)				

No.	Name	Description	Function support		R/W
			FX5UJ	FX5U/ FX5UC	
SD5598	Positioning bias speed [Low-order] (axis 3)	This register stores the bias speed of positioning (axis 3).	○	○	R/W
SD5599	Positioning bias speed [High-order] (axis 3)				
SD5600	Positioning acceleration time (axis 3)	This register stores the acceleration time of positioning (axis 3).	○	○	R/W
SD5601	Positioning deceleration time (axis 3)	This register stores the deceleration time of positioning (axis 3).	○	○	R/W
SD5606	Positioning zero-return speed [Low-order] (axis 3)	This register stores the zero-return speed of positioning (axis 3).	○	○	R/W
SD5607	Positioning zero-return speed [High-order] (axis 3)				
SD5608	Positioning creep speed [Low-order] (axis 3)	This register stores the creep speed of positioning (axis 3).	○	○	R/W
SD5609	Positioning creep speed [High-order] (axis 3)				
SD5610	Positioning zero-point address [Low-order] (axis 3)	This register stores the zero-point address of positioning (axis 3).	○	○	R/W
SD5611	Positioning zero-point address [High-order] (axis 3)				
SD5612	Positioning number of zero-point signal for zero return (axis 3)	This register stores the number of zero-point signal for zero return of positioning (axis 3).	○	○	R/W
SD5613	Positioning zero-return dwell time (axis 3)	This register stores the zero-return dwell time of positioning (axis 3).	○	○	R/W
SD5620	Positioning current address (user unit) [Low-order] (axis 4)	This register stores the current address (user unit) of positioning (axis 4).	×	○	R/W
SD5621	Positioning current address (user unit) [High-order] (axis 4)				
SD5622	Positioning current address (pulse unit) [Low-order] (axis 4)	This register stores the current address (pulse unit) of positioning (axis 4).	×	○	R/W
SD5623	Positioning current address (pulse unit) [High-order] (axis 4)				
SD5624	Positioning current speed (user unit) [Low-order] (axis 4)	This register stores the current speed (user unit) of positioning (axis 4).	×	○	R
SD5625	Positioning current speed (user unit) [High-order] (axis 4)				
SD5626	Positioning execution table number (axis 4)	This register stores the execution table number of positioning (axis 4).	×	○	R
SD5630	Positioning error code (axis 4)	This register stores the error code of positioning (axis 4).	×	○	R/W
SD5631	Positioning error table number (axis 4)	This register stores the error table number of positioning (axis 4).	×	○	R/W
SD5636	Positioning maximum speed [Low-order] (axis 4)	This register stores the maximum speed of positioning (axis 4).	×	○	R/W
SD5637	Positioning maximum speed [High-order] (axis 4)				
SD5638	Positioning bias speed [Low-order] (axis 4)	This register stores the bias speed of positioning (axis 4).	×	○	R/W
SD5639	Positioning bias speed [High-order] (axis 4)				
SD5640	Positioning acceleration time (axis 4)	This register stores the acceleration time of positioning (axis 4).	×	○	R/W
SD5641	Positioning deceleration time (axis 4)	This register stores the deceleration time of positioning (axis 4).	×	○	R/W
SD5646	Positioning zero-return speed [Low-order] (axis 4)	This register stores the zero-return speed of positioning (axis 4).	×	○	R/W
SD5647	Positioning zero-return speed [High-order] (axis 4)				
SD5648	Positioning creep speed [Low-order] (axis 4)	This register stores the creep speed of positioning (axis 4).	×	○	R/W
SD5649	Positioning creep speed [High-order] (axis 4)				
SD5650	Positioning zero-point address [Low-order] (axis 4)	This register stores the zero-point address of positioning (axis 4).	×	○	R/W
SD5651	Positioning zero-point address [High-order] (axis 4)				
SD5652	Positioning number of zero-point signal for zero return (axis 4)	This register stores the number of zero-point signal for zero return of positioning (axis 4).	×	○	R/W
SD5653	Positioning zero-return dwell time (axis 4)	This register stores the zero-return dwell time of positioning (axis 4).	×	○	R/W
SD5660	Positioning current address (user unit) [Low-order] (axis 5)	This register stores the current address (user unit) of positioning (axis 5).	×	○	R/W
SD5661	Positioning current address (user unit) [High-order] (axis 5)				
SD5662	Positioning current address (pulse unit) [Low-order] (axis 5)	This register stores the current address (pulse unit) of positioning (axis 5).	×	○	R/W
SD5663	Positioning current address (pulse unit) [High-order] (axis 5)				
SD5664	Positioning current speed (user unit) [Low-order] (axis 5)	This register stores the current speed of positioning (axis 5).	×	○	R
SD5665	Positioning current speed (user unit) [High-order] (axis 5)				
SD5666	Positioning execution table number (axis 5)	This register stores the execution table number of positioning (axis 5).	×	○	R

No.	Name	Description	Function support		R/W
			FX5UJ	FX5U/ FX5UC	
SD5668	Positioning current speed (composite speed) [Low-order] (axis 5)	This register stores the current speed (composite speed) of positioning (axis 5).	×	○	R
SD5669	Positioning current speed (composite speed) [High-order] (axis 5)				
SD5670	Positioning error code (axis 5)	This register stores the error code of positioning (axis 5).	×	○	R/W
SD5671	Positioning error table number (axis 5)	This register stores the error table number of positioning (axis 5).	×	○	R/W
SD5676	Positioning maximum speed [Low-order] (axis 5)	This register stores the maximum speed of positioning (axis 5).	×	○	R/W
SD5677	Positioning maximum speed [High-order] (axis 5)				
SD5678	Positioning bias speed [Low-order] (axis 5)	This register stores the bias speed of positioning (axis 5).	×	○	R/W
SD5679	Positioning bias speed [High-order] (axis 5)				
SD5680	Positioning acceleration time (axis 5)	This register stores the acceleration time of positioning (axis 5).	×	○	R/W
SD5681	Positioning deceleration time (axis 5)	This register stores the deceleration time of positioning (axis 5).	×	○	R/W
SD5686	Positioning zero-return speed [Low-order] (axis 5)	This register stores the zero-return speed of positioning (axis 5).	×	○	R/W
SD5687	Positioning zero-return speed [High-order] (axis 5)				
SD5688	Positioning creep speed [Low-order] (axis 5)	This register stores the creep speed of positioning (axis 5).	×	○	R/W
SD5689	Positioning creep speed [High-order] (axis 5)				
SD5690	Positioning zero-point address [Low-order] (axis 5)	This register stores the zero-point address of positioning (axis 5).	×	○	R/W
SD5691	Positioning zero-point address [High-order] (axis 5)				
SD5692	Positioning number of zero-point signal for zero return (axis 5)	This register stores the number of zero-point signal for zero return of positioning (axis 5).	×	○	R/W
SD5693	Positioning zero-return dwell time (axis 5)	This register stores the zero-return dwell time of positioning (axis 5).	×	○	R/W
SD5700	Positioning current address (user unit) [Low-order] (axis 6)	This register stores the current address (user unit) of positioning (axis 6).	×	○	R/W
SD5701	Positioning current address (user unit) [High-order] (axis 6)				
SD5702	Positioning current address (pulse unit) [Low-order] (axis 6)	This register stores the current address (pulse unit) of positioning (axis 6).	×	○	R/W
SD5703	Positioning current address (pulse unit) [High-order] (axis 6)				
SD5704	Positioning current speed (user unit) [Low-order] (axis 6)	This register stores the current speed of positioning (axis 6).	×	○	R
SD5705	Positioning current speed (user unit) [High-order] (axis 6)				
SD5706	Positioning execution table number (axis 6)	This register stores the execution table number of positioning (axis 6).	×	○	R
SD5708	Positioning current speed (composite speed) [Low-order] (axis 6)	This register stores the current speed (composite speed) of positioning (axis 6).	×	○	R
SD5709	Positioning current speed (composite speed) [High-order] (axis 6)				
SD5710	Positioning error code (axis 6)	This register stores the error code of positioning (axis 6).	×	○	R/W
SD5711	Positioning error table number (axis 6)	This register stores the error table number of positioning (axis 6).	×	○	R/W
SD5716	Positioning maximum speed [Low-order] (axis 6)	This register stores the maximum speed of positioning (axis 6).	×	○	R/W
SD5717	Positioning maximum speed [High-order] (axis 6)				
SD5718	Positioning bias speed [Low-order] (axis 6)	This register stores the bias speed of positioning (axis 6).	×	○	R/W
SD5719	Positioning bias speed [High-order] (axis 6)				
SD5720	Positioning acceleration time (axis 6)	This register stores the acceleration time of positioning (axis 6).	×	○	R/W
SD5721	Positioning deceleration time (axis 6)	This register stores the deceleration time of positioning (axis 6).	×	○	R/W
SD5726	Positioning zero-return speed [Low-order] (axis 6)	This register stores the zero-return speed of positioning (axis 6).	×	○	R/W
SD5727	Positioning zero-return speed [High-order] (axis 6)				
SD5728	Positioning creep speed [Low-order] (axis 6)	This register stores the creep speed of positioning (axis 6).	×	○	R/W
SD5729	Positioning creep speed [High-order] (axis 6)				

No.	Name	Description	Function support		R/W
			FX5UJ	FX5U/ FX5UC	
SD5730	Positioning zero-point address [Low-order] (axis 6)	This register stores the zero-point address of positioning (axis 6).	×	○	R/W
SD5731	Positioning zero-point address [High-order] (axis 6)				
SD5732	Positioning number of zero-point signal for zero return (axis 6)	This register stores the number of zero-point signal for zero return of positioning (axis 6).	×	○	R/W
SD5733	Positioning zero-return dwell time (axis 6)	This register stores the zero-return dwell time of positioning (axis 6).	×	○	R/W
SD5740	Positioning current address (user unit) [Low-order] (axis 7)	This register stores the current address (user unit) of positioning (axis 7).	×	○	R/W
SD5741	Positioning current address (user unit) [High-order] (axis 7)				
SD5742	Positioning current address (pulse unit) [Low-order] (axis 7)	This register stores the current address (pulse unit) of positioning (axis 7).	×	○	R/W
SD5743	Positioning current address (pulse unit) [High-order] (axis 7)				
SD5744	Positioning current speed (user unit) [Low-order] (axis 7)	This register stores the current speed of positioning (axis 7).	×	○	R
SD5745	Positioning current speed (user unit) [High-order] (axis 7)				
SD5746	Positioning execution table number (axis 7)	This register stores the execution table number of positioning (axis 7).	×	○	R
SD5748	Positioning current speed (composite speed) [Low-order] (axis 7)	This register stores the current speed (composite speed) of positioning (axis 7).	×	○	R
SD5749	Positioning current speed (composite speed) [High-order] (axis 7)				
SD5750	Positioning error code (axis 7)	This register stores the error code of positioning (axis 7).	×	○	R/W
SD5751	Positioning error table number (axis 7)	This register stores the error table number of positioning (axis 7).	×	○	R/W
SD5756	Positioning maximum speed [Low-order] (axis 7)	This register stores the maximum speed of positioning (axis 7).	×	○	R/W
SD5757	Positioning maximum speed [High-order] (axis 7)				
SD5758	Positioning bias speed [Low-order] (axis 7)	This register stores the bias speed of positioning (axis 7).	×	○	R/W
SD5759	Positioning bias speed [High-order] (axis 7)				
SD5760	Positioning acceleration time (axis 7)	This register stores the acceleration time of positioning (axis 7).	×	○	R/W
SD5761	Positioning deceleration time (axis 7)	This register stores the deceleration time of positioning (axis 7).	×	○	R/W
SD5766	Positioning zero-return speed [Low-order] (axis 7)	This register stores the zero-return speed of positioning (axis 7).	×	○	R/W
SD5767	Positioning zero-return speed [High-order] (axis 7)				
SD5768	Positioning creep speed [Low-order] (axis 7)	This register stores the creep speed of positioning (axis 7).	×	○	R/W
SD5769	Positioning creep speed [High-order] (axis 7)				
SD5770	Positioning zero-point address [Low-order] (axis 7)	This register stores the zero-point address of positioning (axis 7).	×	○	R/W
SD5771	Positioning zero-point address [High-order] (axis 7)				
SD5772	Positioning number of zero-point signal for zero return (axis 7)	This register stores the number of zero-point signal for zero return of positioning (axis 7).	×	○	R/W
SD5773	Positioning zero-return dwell time (axis 7)	This register stores the zero-return dwell time of positioning (axis 7).	×	○	R/W
SD5780	Positioning current address (user unit) [Low-order] (axis 8)	This register stores the current address (user unit) of positioning (axis 8).	×	○	R/W
SD5781	Positioning current address (user unit) [High-order] (axis 8)				
SD5782	Positioning current address (pulse unit) [Low-order] (axis 8)	This register stores the current address (pulse unit) of positioning (axis 8).	×	○	R/W
SD5783	Positioning current address (pulse unit) [High-order] (axis 8)				
SD5784	Positioning current speed (user unit) [Low-order] (axis 8)	This register stores the current speed of positioning (axis 8).	×	○	R
SD5785	Positioning current speed (user unit) [High-order] (axis 8)				
SD5786	Positioning execution table number (axis 8)	This register stores the execution table number of positioning (axis 8).	×	○	R
SD5788	Positioning current speed (composite speed) [Low-order] (axis 8)	This register stores the current speed (composite speed) of positioning (axis 8).	×	○	R
SD5789	Positioning current speed (composite speed) [High-order] (axis 8)				
SD5790	Positioning error code (axis 8)	This register stores the error code of positioning (axis 8).	×	○	R/W

No.	Name	Description	Function support		R/W
			FX5UJ	FX5U/ FX5UC	
SD5791	Positioning error table number (axis 8)	This register stores the error table number of positioning (axis 8).	×	○	R/W
SD5796	Positioning maximum speed [Low-order] (axis 8)	This register stores the maximum speed of positioning (axis 8).	×	○	R/W
SD5797	Positioning maximum speed [High-order] (axis 8)				
SD5798	Positioning bias speed [Low-order] (axis 8)	This register stores the bias speed of positioning (axis 8).	×	○	R/W
SD5799	Positioning bias speed [High-order] (axis 8)				
SD5800	Positioning acceleration time (axis 8)	This register stores the acceleration time of positioning (axis 8).	×	○	R/W
SD5801	Positioning deceleration time (axis 8)	This register stores the deceleration time of positioning (axis 8).	×	○	R/W
SD5806	Positioning zero-return speed [Low-order] (axis 8)	This register stores the zero-return speed of positioning (axis 8).	×	○	R/W
SD5807	Positioning zero-return speed [High-order] (axis 8)				
SD5808	Positioning creep speed [Low-order] (axis 8)	This register stores the creep speed of positioning (axis 8).	×	○	R/W
SD5809	Positioning creep speed [High-order] (axis 8)				
SD5810	Positioning zero-point address [Low-order] (axis 8)	This register stores the zero-point address of positioning (axis 8).	×	○	R/W
SD5811	Positioning zero-point address [High-order] (axis 8)				
SD5812	Positioning number of zero-point signal for zero return (axis 8)	This register stores the number of zero-point signal for zero return of positioning (axis 8).	×	○	R/W
SD5813	Positioning zero-return dwell time (axis 8)	This register stores the zero-return dwell time of positioning (axis 8).	×	○	R/W
SD5820	Positioning current address (user unit) [Low-order] (axis 9)	This register stores the current address (user unit) of positioning (axis 9).	×	○	R/W
SD5821	Positioning current address (user unit) [High-order] (axis 9)				
SD5822	Positioning current address (pulse unit) [Low-order] (axis 9)	This register stores the current address (pulse unit) of positioning (axis 9).	×	○	R/W
SD5823	Positioning current address (pulse unit) [High-order] (axis 9)				
SD5824	Positioning current speed (user unit) [Low-order] (axis 9)	This register stores the current speed of positioning (axis 9).	×	○	R
SD5825	Positioning current speed (user unit) [High-order] (axis 9)				
SD5826	Positioning execution table number (axis 9)	This register stores the execution table number of positioning (axis 9).	×	○	R
SD5828	Positioning current speed (composite speed) [Low-order] (axis 9)	This register stores the current speed (composite speed) of positioning (axis 9).	×	○	R
SD5829	Positioning current speed (composite speed) [High-order] (axis 9)				
SD5830	Positioning error code (axis 9)	This register stores the error code of positioning (axis 9).	×	○	R/W
SD5831	Positioning error table number (axis 9)	This register stores the error table number of positioning (axis 9).	×	○	R/W
SD5836	Positioning maximum speed [Low-order] (axis 9)	This register stores the maximum speed of positioning (axis 9).	×	○	R/W
SD5837	Positioning maximum speed [High-order] (axis 9)				
SD5838	Positioning bias speed [Low-order] (axis 9)	This register stores the bias speed of positioning (axis 9).	×	○	R/W
SD5839	Positioning bias speed [High-order] (axis 9)				
SD5840	Positioning acceleration time (axis 9)	This register stores the acceleration time of positioning (axis 9).	×	○	R/W
SD5841	Positioning deceleration time (axis 9)	This register stores the deceleration time of positioning (axis 9).	×	○	R/W
SD5846	Positioning zero-return speed [Low-order] (axis 9)	This register stores the zero-return speed of positioning (axis 9).	×	○	R/W
SD5847	Positioning zero-return speed [High-order] (axis 9)				
SD5848	Positioning creep speed [Low-order] (axis 9)	This register stores the creep speed of positioning (axis 9).	×	○	R/W
SD5849	Positioning creep speed [High-order] (axis 9)				
SD5850	Positioning zero-point address [Low-order] (axis 9)	This register stores the zero-point address of positioning (axis 9).	×	○	R/W
SD5851	Positioning zero-point address [High-order] (axis 9)				
SD5852	Positioning number of zero-point signal for zero return (axis 9)	This register stores the number of zero-point signal for zero return of positioning (axis 9).	×	○	R/W
SD5853	Positioning zero-return dwell time (axis 9)	This register stores the zero-return dwell time of positioning (axis 9).	×	○	R/W

No.	Name	Description	Function support		R/W
			FX5UJ	FX5U/ FX5UC	
SD5860	Positioning current address (user unit) [Low-order] (axis 10)	This register stores the current address (user unit) of positioning (axis 10).	×	○	R/W
SD5861	Positioning current address (user unit) [High-order] (axis 10)				
SD5862	Positioning current address (pulse unit) [Low-order] (axis 10)	This register stores the current address (pulse unit) of positioning (axis 10).	×	○	R/W
SD5863	Positioning current address (pulse unit) [High-order] (axis 10)				
SD5864	Positioning current speed (user unit) [Low-order] (axis 10)	This register stores the current speed of positioning (axis 10).	×	○	R
SD5865	Positioning current speed (user unit) [High-order] (axis 10)				
SD5866	Positioning execution table number (axis 10)	This register stores the execution table number of positioning (axis 10).	×	○	R
SD5868	Positioning current speed (composite speed) [Low-order] (axis 10)	This register stores the current speed (composite speed) of positioning (axis 10).	×	○	R
SD5869	Positioning current speed (composite speed) [High-order] (axis 10)				
SD5870	Positioning error code (axis 10)	This register stores the error code of positioning (axis 10).	×	○	R/W
SD5871	Positioning error table number (axis 10)	This register stores the error table number of positioning (axis 10).	×	○	R/W
SD5876	Positioning maximum speed [Low-order] (axis 10)	This register stores the maximum speed of positioning (axis 10).	×	○	R/W
SD5877	Positioning maximum speed [High-order] (axis 10)				
SD5878	Positioning bias speed [Low-order] (axis 10)	This register stores the bias speed of positioning (axis 10).	×	○	R/W
SD5879	Positioning bias speed [High-order] (axis 10)				
SD5880	Positioning acceleration time (axis 10)	This register stores the acceleration time of positioning (axis 10).	×	○	R/W
SD5881	Positioning deceleration time (axis 10)	This register stores the deceleration time of positioning (axis 10).	×	○	R/W
SD5886	Positioning zero-return speed [Low-order] (axis 10)	This register stores the zero-return speed of positioning (axis 10).	×	○	R/W
SD5887	Positioning zero-return speed [High-order] (axis 10)				
SD5888	Positioning creep speed [Low-order] (axis 10)	This register stores the creep speed of positioning (axis 10).	×	○	R/W
SD5889	Positioning creep speed [High-order] (axis 10)				
SD5890	Positioning zero-point address [Low-order] (axis 10)	This register stores the zero-point address of positioning (axis 10).	×	○	R/W
SD5891	Positioning zero-point address [High-order] (axis 10)				
SD5892	Positioning number of zero-point signal for zero return (axis 10)	This register stores the number of zero-point signal for zero return of positioning (axis 10).	×	○	R/W
SD5893	Positioning zero-return dwell time (axis 10)	This register stores the zero-return dwell time of positioning (axis 10).	×	○	R/W
SD5900	Positioning current address (user unit) [Low-order] (axis 11)	This register stores the current address (user unit) of positioning (axis 11).	×	○	R/W
SD5901	Positioning current address (user unit) [High-order] (axis 11)				
SD5902	Positioning current address (pulse unit) [Low-order] (axis 11)	This register stores the current address (pulse unit) of positioning (axis 11).	×	○	R/W
SD5903	Positioning current address (pulse unit) [High-order] (axis 11)				
SD5904	Positioning current speed (user unit) [Low-order] (axis 11)	This register stores the current speed of positioning (axis 11).	×	○	R
SD5905	Positioning current speed (user unit) [High-order] (axis 11)				
SD5906	Positioning execution table number (axis 11)	This register stores the execution table number of positioning (axis 11).	×	○	R
SD5908	Positioning current speed (composite speed) [Low-order] (axis 11)	This register stores the current speed (composite speed) of positioning (axis 11).	×	○	R
SD5909	Positioning current speed (composite speed) [High-order] (axis 11)				
SD5910	Positioning error code (axis 11)	This register stores the error code of positioning (axis 11).	×	○	R/W
SD5911	Positioning error table number (axis 11)	This register stores the error table number of positioning (axis 11).	×	○	R/W
SD5916	Positioning maximum speed [Low-order] (axis 11)	This register stores the maximum speed of positioning (axis 11).	×	○	R/W
SD5917	Positioning maximum speed [High-order] (axis 11)				
SD5918	Positioning bias speed [Low-order] (axis 11)	This register stores the bias speed of positioning (axis 11).	×	○	R/W
SD5919	Positioning bias speed [High-order] (axis 11)				

No.	Name	Description	Function support		R/W
			FX5UJ	FX5U/ FX5UC	
SD5920	Positioning acceleration time (axis 11)	This register stores the acceleration time of positioning (axis 11).	×	○	R/W
SD5921	Positioning deceleration time (axis 11)	This register stores the deceleration time of positioning (axis 11).	×	○	R/W
SD5926	Positioning zero-return speed [Low-order] (axis 11)	This register stores the zero-return speed of positioning (axis 11).	×	○	R/W
SD5927	Positioning zero-return speed [High-order] (axis 11)				
SD5928	Positioning creep speed [Low-order] (axis 11)	This register stores the creep speed of positioning (axis 11).	×	○	R/W
SD5929	Positioning creep speed [High-order] (axis 11)				
SD5930	Positioning zero-point address [Low-order] (axis 11)	This register stores the zero-point address of positioning (axis 11).	×	○	R/W
SD5931	Positioning zero-point address [High-order] (axis 11)				
SD5932	Positioning number of zero-point signal for zero return (axis 11)	This register stores the number of zero-point signal for zero return of positioning (axis 11).	×	○	R/W
SD5933	Positioning zero-return dwell time (axis 11)	This register stores the zero-return dwell time of positioning (axis 11).	×	○	R/W
SD5940	Positioning current address (user unit) [Low-order] (axis 12)	This register stores the current address (user unit) of positioning (axis 12).	×	○	R/W
SD5941	Positioning current address (user unit) [High-order] (axis 12)				
SD5942	Positioning current address (pulse unit) [Low-order] (axis 12)	This register stores the current address (pulse unit) of positioning (axis 12).	×	○	R/W
SD5943	Positioning current address (pulse unit) [High-order] (axis 12)				
SD5944	Positioning current speed (user unit) [Low-order] (axis 12)	This register stores the current speed of positioning (axis 12).	×	○	R
SD5945	Positioning current speed (user unit) [High-order] (axis 12)				
SD5946	Positioning execution table number (axis 12)	This register stores the execution table number of positioning (axis 12).	×	○	R
SD5948	Positioning current speed (composite speed) [Low-order] (axis 12)	This register stores the current speed (composite speed) of positioning (axis 12).	×	○	R
SD5949	Positioning current speed (composite speed) [High-order] (axis 12)				
SD5950	Positioning error code (axis 12)	This register stores the error code of positioning (axis 12).	×	○	R/W
SD5951	Positioning error table number (axis 12)	This register stores the error table number of positioning (axis 12).	×	○	R/W
SD5956	Positioning maximum speed [Low-order] (axis 12)	This register stores the maximum speed of positioning (axis 12).	×	○	R/W
SD5957	Positioning maximum speed [High-order] (axis 12)				
SD5958	Positioning bias speed [Low-order] (axis 12)	This register stores the bias speed of positioning (axis 12).	×	○	R/W
SD5959	Positioning bias speed [High-order] (axis 12)				
SD5960	Positioning acceleration time (axis 12)	This register stores the acceleration time of positioning (axis 12).	×	○	R/W
SD5961	Positioning deceleration time (axis 12)	This register stores the deceleration time of positioning (axis 12).	×	○	R/W
SD5966	Positioning zero-return speed [Low-order] (axis 12)	This register stores the zero-return speed of positioning (axis 12).	×	○	R/W
SD5967	Positioning zero-return speed [High-order] (axis 12)				
SD5968	Positioning creep speed [Low-order] (axis 12)	This register stores the creep speed of positioning (axis 12).	×	○	R/W
SD5969	Positioning creep speed [High-order] (axis 12)				
SD5970	Positioning zero-point address [Low-order] (axis 12)	This register stores the zero-point address of positioning (axis 12).	×	○	R/W
SD5971	Positioning zero-point address [High-order] (axis 12)				
SD5972	Positioning number of zero-point signal for zero return (axis 12)	This register stores the number of zero-point signal for zero return of positioning (axis 12).	×	○	R/W
SD5973	Positioning zero-return dwell time (axis 12)	This register stores the zero-return dwell time of positioning (axis 12).	×	○	R/W

Built-in analog

The special registers for built-in analog are shown below.

○: Supported, ×: Not supported

R: Read only, R/W: Read/Write

No.	Name	Description	Function support		R/W
			FX5UJ	FX5U/ FX5UC*1	
SD6020	CH1 Digital output value	This register stores the digital output value.	×	○	R
SD6021	CH1 Digital operation value	This register stores the digital operation value.	×	○	R
SD6022	CH1 Analog input voltage monitor	This register stores the analog input voltage value.	×	○	R
SD6023	CH1 Averaging process setting	This register stores the averaging process setting.	×	○	R/W
SD6024	CH1 Time Average/Frequency Average/ Moving Average	This register stores the time average/frequency average/moving average.	×	○	R/W
SD6026	CH1 Maximum value	This register stores the maximum value.	×	○	R
SD6027	CH1 Minimum value	This register stores the minimum value.	×	○	R
SD6028	CH1 Scaling upper limit value	This register stores the scaling upper limit value.	×	○	R/W
SD6029	CH1 Scaling lower limit value	This register stores the scaling lower limit value.	×	○	R/W
SD6030	CH1 Shifting amount to conversion value	This register stores the shifting amount of conversion value.	×	○	R/W
SD6031	CH1 Process alarm upper upper limit value	This register stores the process alarm upper upper limit value.	×	○	R/W
SD6032	CH1 Process alarm upper lower limit value	This register stores the process alarm upper lower limit value.	×	○	R/W
SD6033	CH1 Process alarm lower upper limit value	This register stores the process alarm lower upper limit value.	×	○	R/W
SD6034	CH1 Process alarm lower lower limit value	This register stores the process alarm lower lower limit value.	×	○	R/W
SD6058	CH1 A/D latest alarm code	This register stores the latest alarm code.	×	○	R
SD6059	CH1 A/D latest error code	This register stores the latest error code.	×	○	R
SD6060	Ch2 Digital output value	This register stores the digital output value.	×	○	R
SD6061	CH2 Digital operation value	This register stores the digital operation value.	×	○	R
SD6062	CH2 Analog input voltage monitor	This register stores the analog input voltage value.	×	○	R
SD6063	CH2 Averaging process setting	This register stores the averaging process setting.	×	○	R/W
SD6064	CH2 Time Average/Frequency Average/ Moving Average	This register stores the time average/frequency average/moving average.	×	○	R/W
SD6066	CH2 Maximum value	This register stores the maximum value.	×	○	R
SD6067	CH2 Minimum value	This register stores the minimum value.	×	○	R
SD6068	CH2 Scaling upper limit value	This register stores the scaling upper limit value.	×	○	R/W
SD6069	CH2 Scaling lower limit value	This register stores the scaling lower limit value.	×	○	R/W
SD6070	CH2 Shifting amount to conversion value	This register stores the shifting amount of conversion value.	×	○	R/W
SD6071	CH2 Process alarm upper upper limit value	This register stores the process alarm upper upper limit value.	×	○	R/W
SD6072	CH2 Process alarm upper lower limit value	This register stores the process alarm upper lower limit value.	×	○	R/W
SD6073	CH2 Process alarm lower upper limit value	This register stores the process alarm lower upper limit value.	×	○	R/W
SD6074	CH2 Process alarm lower lower limit value	This register stores the process alarm lower lower limit value.	×	○	R/W
SD6098	CH2 A/D latest alarm code	This register stores the latest alarm code.	×	○	R
SD6099	CH2 A/D latest error code	This register stores the latest error code.	×	○	R
SD6180	Digital input value	This register stores the digital input value.	×	○	R/W
SD6181	Digital operation value	This register stores the digital operation value.	×	○	R
SD6182	Analog output voltage monitor	This register stores the analog output voltage value.	×	○	R
SD6183	HOLD/CLEAR setting	This register stores the HOLD/CLEAR setting.	×	○	R/W
SD6184	HOLD setting value	This register stores the HOLD setting value.	×	○	R/W
SD6188	Scaling upper limit value	This register stores the scaling upper limit value.	×	○	R/W
SD6189	Scaling lower limit value	This register stores the scaling lower limit value.	×	○	R/W
SD6190	Input value shift amount	This register stores the input value shift amount.	×	○	R/W
SD6191	Warning output upper limit value	This register stores the warning output upper limit value.	×	○	R/W
SD6192	Warning output lower limit value	This register stores the warning output lower limit value.	×	○	R/W
SD6218	D/A latest alarm code	This register stores the latest alarm code.	×	○	R
SD6219	D/A latest error code	This register stores the latest error code.	×	○	R

*1 Only FX5U CPU module is supported.

FX Compatible area

The special registers for FX compatible area are shown below.

○: Supported, ×: Not supported

R: Read only, R/W: Read/Write

No.	Name	Description	Function support		R/W
			FX5UJ	FX5U/ FX5UC	
SD8000	Watchdog timer	This register stores the watchdog timer.	○	○	R/W
SD8001	PLC type and system version	This register stores the PLC type and system version.	○	○	R
SD8005	Battery voltage	This register stores the battery voltage. (units: 0.1 V)	×	○	R
SD8006	Low battery voltage	This register stores the low battery voltage. (units: 0.1 V)	×	○	R/W
SD8007	Power failure count	This register stores the power failure count.	○	○	R
SD8008	Power failure detection period	This register stores the power failure detection period. When the power supply voltage is 200 V AC, the time can be change to 10 to 100 ms.	○	○	R/W
SD8010	Current scan time	This register stores the current scan time. (units: 0.1 ms)	○	○	R
SD8011	Minimum scan time	This register stores the minimum scan time. (units: 0.1 ms)	○	○	R
SD8012	Maximum scan time	This register stores the maximum scan time. (units: 0.1 ms)	○	○	R
SD8013	RTC: Seconds	This register stores the seconds data.	○	○	R/W
SD8014	RTC: Minute data	This register stores the minute data.	○	○	R/W
SD8015	RTC: Hour data	This register stores the hour data.	○	○	R/W
SD8016	RTC: Day data	This register stores the day data.	○	○	R/W
SD8017	RTC: Month data	This register stores the month data.	○	○	R/W
SD8018	RTC: Year data	This register stores the year data.	○	○	R/W
SD8019	RTC: Day of week data	This register stores the day of week data.	○	○	R/W
SD8039	Constant scan duration	This register stores the constant scan duration. 0 to 2000 (unit: 1 ms)	○	○	R/W
SD8040 ^{*1}	ON state number 1	This register stores the ON state number 1.	○	○	R/W
SD8041 ^{*1}	ON state number 2	This register stores the ON state number 2.	○	○	R/W
SD8042 ^{*1}	ON state number 3	This register stores the ON state number 3.	○	○	R/W
SD8043 ^{*1}	ON state number 4	This register stores the ON state number 4.	○	○	R/W
SD8044 ^{*1}	ON state number 5	This register stores the ON state number 5.	○	○	R/W
SD8045 ^{*1}	ON state number 6	This register stores the ON state number 6.	○	○	R/W
SD8046 ^{*1}	ON state number 7	This register stores the ON state number 7.	○	○	R/W
SD8047 ^{*1}	ON state number 8	This register stores the ON state number 8.	○	○	R/W
SD8049	Lowest active Annunciator	This register stores the lowest active annunciator.	○	○	R/W
SD8063	Serial communication error code (CH1)	This register stores the serial communication error code (CH1).	○	○	R
SD8067	Operation error	This register stores the error code number of operation error.	○	○	R
SD8099	High speed ring counter	This register stores the high speed ring counter count value. (units: 0.1 ms)	○	○	R/W
SD8126	Computer link model code	This register stores the model code to be read out by PC command in the low order 8 bits.	○	○	R/W
SD8136	PLSY Output number [Low-order]	This register stores the PLSY instruction output pulse number.	○	○	R/W
SD8137	PLSY Output number [High-order]				
SD8140	PLSY Accumulated number of pulses output [Low-order] (axis 1)	This register stores the PLSY instruction accumulated number of pulses output (to axis 1).	○	○	R/W
SD8141	PLSY Accumulated number of pulses output [High-order] (axis 1)				
SD8142	PLSY Accumulated number of pulses output [Low-order] (axis 2)	This register stores the PLSY instruction accumulated number of pulses output (to axis 2).	○	○	R/W
SD8143	PLSY Accumulated number of pulses output [High-order] (axis 2)				
SD8152	Error No. of Inverter communication (CH1)	This register stores the error code of Inverter communication (CH1).	○	○	R

A

No.	Name	Description	Function support		R/W
			FX5UJ	FX5U/ FX5UC	
SD8154	Error parameter No. of IVBWR (CH1)	This register stores the error parameter No. of IVBWR instruction (CH1).	○	○	R
SD8157	Error No. of Inverter communication (CH2)	This register stores the error code of Inverter communication (CH2).	○	○	R
SD8159	Error parameter No. of IVBWR (CH2)	This register stores the error parameter No. of IVBWR instruction (CH2).	○	○	R
SD8166	Module error occurrence conditions (Module connection position 1 to 15)	b0: No error b1: Module connection No.1 b2: Module connection No.2 b3: Module connection No.3 b4: Module connection No.4 b5: Module connection No.5 b6: Module connection No.6 b7: Module connection No.7 b8: Module connection No.8 b9: Module connection No.9 b10: Module connection No.10 Enabled only when the STL instruction is used. b11: Module connection No.11 ^{*2} b12: Module connection No.12 ^{*2} b13: Module connection No.13 ^{*2} b14: Module connection No.14 ^{*2} b15: Module connection No.15 ^{*2} 0: No error 1: Error	○	○	R
SD8167	Module error occurrence conditions (Module connection position 16 to 18)	b0: Module connection No.16 b1: Module connection No.17 b2: Module connection No.18 0: No error 1: Error	×	○	R
SD8173	Station number	This register stores the station number.	○	○	R
SD8174	Total number of slave stations	This register stores the total number of slave stations.	○	○	R
SD8175	Refresh range	This register stores the refresh range.	○	○	R
SD8201	Current link scan time	This register stores the current link scan time.	○	○	R
SD8202	Maximum link scan time	This register stores the maximum link scan time.	○	○	R
SD8203	Number of communication error at master station	This register stores the number of communication error at master station.	○	○	R
SD8204	Number of communication error at slave station No.1	This register stores the number of communication error at slave station No.1.	○	○	R
SD8205	Number of communication error at slave station No.2	This register stores the number of communication error at slave station No.2.	○	○	R
SD8206	Number of communication error at slave station No.3	This register stores the number of communication error at slave station No.3.	○	○	R
SD8207	Number of communication error at slave station No.4	This register stores the number of communication error at slave station No.4.	○	○	R
SD8208	Number of communication error at slave station No.5	This register stores the number of communication error at slave station No.5.	○	○	R
SD8209	Number of communication error at slave station No.6	This register stores the number of communication error at slave station No.6.	○	○	R
SD8210	Number of communication error at slave station No.7	This register stores the number of communication error at slave station No.7.	○	○	R
SD8211	Code of communication error at master station	This register stores the code of communication error at master station.	○	○	R
SD8212	Code of communication error at slave station No.1	This register stores the code of communication error at slave station No.1.	○	○	R
SD8213	Code of communication error at slave station No.2	This register stores the code of communication error at slave station No.2.	○	○	R
SD8214	Code of communication error at slave station No.3	This register stores the code of communication error at slave station No.3.	○	○	R
SD8215	Code of communication error at slave station No.4	This register stores the code of communication error at slave station No.4.	○	○	R

No.	Name	Description	Function support		R/W
			FX5UJ	FX5U/ FX5UC	
SD8216	Code of communication error at slave station No.5	This register stores the code of communication error at slave station No.5.	○	○	R
SD8217	Code of communication error at slave station No.6	This register stores the code of communication error at slave station No.6.	○	○	R
SD8218	Code of communication error at slave station No.7	This register stores the code of communication error at slave station No.7.	○	○	R
SD8230	Number of communication error at master station	This register stores the number of communication error at master station.	○	○	R
SD8231	Number of communication error at slave station No.1	This register stores the number of communication error at slave station No.1.	○	○	R
SD8232	Number of communication error at slave station No.2	This register stores the number of communication error at slave station No.2.	○	○	R
SD8233	Number of communication error at slave station No.3	This register stores the number of communication error at slave station No.3.	○	○	R
SD8234	Number of communication error at slave station No.4	This register stores the number of communication error at slave station No.4.	○	○	R
SD8235	Number of communication error at slave station No.5	This register stores the number of communication error at slave station No.5.	○	○	R
SD8236	Number of communication error at slave station No.6	This register stores the number of communication error at slave station No.6.	○	○	R
SD8237	Number of communication error at slave station No.7	This register stores the number of communication error at slave station No.7.	○	○	R
SD8310	RND Random number generation [Low-order]	This register stores the RND random number generation data.	○	○	R
SD8311	RND Random number generation [High-order]				
SD8330	Counted number of scans for timing clock output 1	This register stores the scan count for timing clock output 1.	○	○	R
SD8331	Counted number of scans for timing clock output 2	This register stores the scan count for timing clock output 2.	○	○	R
SD8332	Counted number of scans for timing clock output 3	This register stores the scan count for timing clock output 3.	○	○	R
SD8333	Counted number of scans for timing clock output 4	This register stores the scan count for timing clock output 4.	○	○	R
SD8334	Counted number of scans for timing clock output 5	This register stores the scan count for timing clock output 5.	○	○	R
SD8340	Current address [Low-order] (axis 1: pulse units)	This register stores the current address (axis 1: pulse units).	○	○	R
SD8341	Current address [High-order] (axis 1: pulse units)				
SD8350	Current address [Low-order] (axis 2: pulse units)	This register stores the current address (axis 2: pulse units).	○	○	R
SD8351	Current address [High-order] (axis 2: pulse units)				
SD8360	Current address [Low-order] (axis 3: pulse units)	This register stores the current address (axis 3: pulse units).	○	○	R
SD8361	Current address [High-order] (axis 3: pulse units)				
SD8370	Current address [Low-order] (axis 4: pulse units)	This register stores the current address (axis 4: pulse units).	×	○	R
SD8371	Current address [High-order] (axis 4: pulse units)				
SD8398	1 ms ring counter [Low-order]	This register stores the 1 ms ring counter.	○	○	R
SD8399	1 ms ring counter [High-order]				
SD8402	RS2 amount of remaining data (CH1)/MODBUS communication error code (CH1)	This register stores the amount of remaining data(CH1)/MODBUS communication error code (CH1).	○	○	R
SD8403	RS2 receive data points (CH1)/MODBUS communication error details (CH1)	This register stores the receive data points (CH1)/MODBUS communication error details (CH1).	○	○	R

No.	Name	Description	Function support		R/W
			FX5UJ	FX5U/ FX5UC	
SD8405	RS2 communication parameter display (CH1)/MODBUS communication format display (CH1)	This register stores the communication parameter display (CH1)/MODBUS communication format display (CH1).	○	○	R
SD8408	MODBUS communication retry times (CH1)	This register stores the MODBUS communication current retry times (CH1).	○	○	R
SD8414	RS2 receive sum (received data) (CH1)	This register stores the CH1 receive sum (received data).	○	○	R
SD8415	RS2 receive sum (calculated result) (CH1)	This register stores the CH1 receive sum (calculated result) .	○	○	R
SD8416	RS2 send sum (CH1)	This register stores the send sum (CH1).	○	○	R
SD8419	Operation mode (CH1)	This register stores the operation mode (CH1).	○	○	R
SD8422	RS2 amount of remaining data (CH2)/MODBUS communication error code (CH2)	This register stores the amount of remaining data (CH2)/MODBUS communication error code (CH2).	○	○	R
SD8423	RS2 receive data points (CH2)/MODBUS communication error details (CH2)	This register stores the receive data points (CH2)/MODBUS communication error details (CH2).	○	○	R
SD8425	RS2 Communication Parameter Display/MODBUS Communication Format Display (CH2)	This register stores the receive sum (calculated result).	○	○	R
SD8428	MODBUS communication retry times (CH2)	This register stores the MODBUS communication current retry times (CH2).	○	○	R
SD8434	RS2 receive sum (received data) (CH2)	This register stores the CH2 receive sum (received data).	○	○	R
SD8435	RS2 receive sum (calculated result) (CH2)	This register stores the CH2 receive sum (calculated result).	○	○	R
SD8436	RS2 send sum (CH2)	This register stores the send sum (CH2).	○	○	R
SD8438	Serial communication error code (CH2)	This register stores the serial communication error code (CH2).	○	○	R
SD8439	Operation mode (CH2)	This register stores the operation mode (CH2).	○	○	R
SD8492	IP address setting [Low-order]	This register stores the IP address.	○	○	R/W
SD8493	IP address setting [High-order]				
SD8494	Subnet mask setting [Low-order]	This register stores the subnet mask.	○	○	R/W
SD8495	Subnet mask setting [High-order]				
SD8496	Default gateway IP address setting [Low-order]	This register stores the default gateway IP address.	○	○	R/W
SD8497	Default gateway IP address setting [High-order]				
SD8498	IP address storage area write error code	This register stores error codes if writing to IP address storage area is failed.	○	○	R
SD8499	IP address storage area clear error code	This register stores error codes if clear to IP address storage area is failed.	○	○	R

*1 Enabled only when the STL instruction is used.

*2 Only FX5U/FX5UC CPU module is supported.

Serial communication

The special registers for serial communication are shown below.

○: Supported, ×: Not supported

R: Read only, W: Write only, R/W: Read/Write

No.	Name	Description	Function support		R/W
			FX5UJ	FX5U/ FX5UC*1	
SD8500	Serial communication error code (CH1)	This register stores the serial communication error code 1 (CH1).	×	○	R
SD8501	Serial communication error details (CH1)	This register stores the serial communication error details 1 (CH1).	×	○	R
SD8502	Serial communication setting (CH1)	This register stores the serial communication setting (CH1).	×	○	R
SD8503	Serial communication operational mode (CH1)	This register stores the serial communication operational mode 1 (CH1).	×	○	R
SD8510	Serial communication error code (CH2)	This register stores the serial communication error code 2 (CH2).	○	○	R
SD8511	Serial communication error details (CH2)	This register stores the serial communication error details 2 (CH2).	○	○	R
SD8512	Serial communication setting (CH2)	This register stores the serial communication setting (CH2).	○	○	R

No.	Name	Description	Function support		R/W
			FX5UJ	FX5U/ FX5UC*1	
SD8513	Serial communication operational mode (CH2)	This register stores the serial communication operational mode 2 (CH2).	○	○	R
SD8520	Serial communication error code (CH3)	This register stores the serial communication error code 3 (CH3).	○	○	R
SD8521	Serial communication error details (CH3)	This register stores the serial communication error details 3 (CH3).	○	○	R
SD8522	Serial communication setting (CH3)	This register stores the serial communication setting (CH3).	○	○	R
SD8523	Serial communication operational mode (CH3)	This register stores the serial communication operational mode 3 (CH3).	○	○	R
SD8530	Serial communication error code (CH4)	This register stores the serial communication error code 4 (CH4).	○	○	R
SD8531	Serial communication error details (CH4)	This register stores the serial communication error details 4 (CH4).	○	○	R
SD8532	Serial communication setting (CH4)	This register stores the serial communication setting (CH4).	○	○	R
SD8533	Serial communication operational mode (CH4)	This register stores the serial communication operational mode 4 (CH4).	○	○	R
SD8560	Remaining points of send data (CH1)	This register stores the remaining points of send data (CH1).	×	○	R
SD8561	Receive data points monitor (CH1)	This register stores the receive data points monitor (CH1).	×	○	R
SD8563	Receive sum (received data) (CH1)	This register stores the receive sum (received data) (CH1).	×	○	R
SD8564	Receive sum (received result) (CH1)	This register stores the receive sum (received result) (CH1).	×	○	R
SD8565	Send sum (CH1)	This register stores the send sum (CH1).	×	○	R
SD8570	Remaining points of send data (CH2)	This register stores the remaining points of send data (CH2).	○	○	R
SD8571	Receive data points monitor (CH2)	This register stores the receive data points monitor (CH2).	○	○	R
SD8573	Receive sum (received data) (CH2)	This register stores the receive sum (received data) (CH2).	○	○	R
SD8574	Receive sum (received result) (CH2)	This register stores the receive sum (received result) (CH2).	○	○	R
SD8575	Send sum (CH2)	This register stores the send sum (CH2).	○	○	R
SD8580	Remaining points of send data (CH3)	This register stores the remaining points of send data (CH3).	○	○	R
SD8581	Receive data points monitor (CH3)	This register stores the receive data points monitor (CH3).	○	○	R
SD8583	Receive sum (received data) (CH3)	This register stores the receive sum (received data) (CH3).	○	○	R
SD8584	Receive sum (received result) (CH3)	This register stores the receive sum (received result) (CH3).	○	○	R
SD8585	Send sum (CH3)	This register stores the send sum (CH3).	○	○	R
SD8590	Remaining points of send data (CH4)	This register stores the remaining points of send data (CH4).	○	○	R
SD8591	Receive data points monitor (CH4)	This register stores the receive data points monitor (CH4).	○	○	R
SD8593	Receive sum (received data) (CH4)	This register stores the receive sum (received data) (CH4).	○	○	R
SD8594	Receive sum (received result) (CH4)	This register stores the receive sum (received result) (CH4).	○	○	R
SD8595	Send sum (CH4)	This register stores the send sum (CH4).	○	○	R
SD8621	Timeout time (CH1)	This register stores the timeout time (CH1).	×	○	R/W
SD8622	8-bit processing mode (CH1)	This register stores the 8-bit processing mode (CH1).	×	○	R/W
SD8623	Header 1 and 2 (CH1)	This register stores the header 1 and 2 (CH1).	×	○	R/W
SD8624	Header 3 and 4 (CH1)	This register stores the header 3 and 4 (CH1).	×	○	R/W
SD8625	Terminator 1 and 2 (CH1)	This register stores the terminator 1 and 2 (CH1).	×	○	R/W
SD8626	Terminator 3 and 4 (CH1)	This register stores the terminator 3 and 4 (CH1).	×	○	R/W
SD8631	Timeout time (CH2)	This register stores the timeout time (CH2).	○	○	R/W
SD8632	8-bit processing mode (CH2)	This register stores the 8-bit processing mode (CH2).	○	○	R/W
SD8633	Header 1 and 2 (CH2)	This register stores the header 1 and 2 (CH2).	○	○	R/W
SD8634	Header 3 and 4 (CH2)	This register stores the header 3 and 4 (CH2).	○	○	R/W
SD8635	Terminator 1 and 2 (CH2)	This register stores the terminator 1 and 2 (CH2).	○	○	R/W
SD8636	Terminator 3 and 4 (CH2)	This register stores the terminator 3 and 4 (CH2).	○	○	R/W
SD8641	Timeout time (CH3)	This register stores the timeout time (CH3).	○	○	R/W
SD8642	8-bit processing mode (CH3)	This register stores the 8-bit processing mode (CH3).	○	○	R/W
SD8643	Header 1 and 2 (CH3)	This register stores the header 1 and 2 (CH3).	○	○	R/W
SD8644	Header 3 and 4 (CH3)	This register stores the header 3 and 4 (CH3).	○	○	R/W
SD8645	Terminator 1 and 2 (CH3)	This register stores the terminator 1 and 2 (CH3).	○	○	R/W
SD8646	Terminator 3 and 4 (CH3)	This register stores the terminator 3 and 4 (CH3).	○	○	R/W

No.	Name	Description	Function support		R/W
			FX5UJ	FX5U/ FX5UC*1	
SD8651	Timeout time (CH4)	This register stores the timeout time (CH4).	○	○	R/W
SD8652	8-bit processing mode (CH4)	This register stores the 8-bit processing mode (CH4).	○	○	R/W
SD8653	Header 1 and 2 (CH4)	This register stores the header 1 and 2 (CH4).	○	○	R/W
SD8654	Header 3 and 4 (CH4)	This register stores the header 3 and 4 (CH4).	○	○	R/W
SD8655	Terminator 1 and 2 (CH4)	This register stores the terminator 1 and 2 (CH4).	○	○	R/W
SD8656	Terminator 3 and 4 (CH4)	This register stores the terminator 3 and 4 (CH4).	○	○	R/W
SD8740	Station number setting (CH1)	This register stores the station number setting (CH1).	×	○	*2
SD8741	Message frame and form (CH1)	This register stores the message frame and form (CH1).	×	○	R
SD8742	Timeout time (CH1)	This register stores the timeout time (CH1).	×	○	R
SD8744	Message waiting time (CH1)	Message waiting time (CH1) is stored.	×	○	R
SD8750	Station number setting (CH2)	This register stores the station number setting (CH2).	○	○	*2
SD8751	Message frame and form (CH2)	This register stores the message frame and form (CH2).	○	○	R
SD8752	Timeout time (CH2)	This register stores the timeout time (CH2).	○	○	R
SD8754	Message waiting time (CH2)	Message waiting time (CH2) is stored.	○	○	R
SD8760	Station number setting (CH3)	This register stores the station number setting (CH3).	○	○	*2
SD8761	Message frame and form (CH3)	This register stores the message frame and form (CH3).	○	○	R
SD8762	Timeout time (CH3)	This register stores the timeout time (CH3).	○	○	R
SD8764	Message waiting time (CH3)	Message waiting time (CH3) is stored.	○	○	R
SD8770	Station number setting (CH4)	This register stores the station number setting (CH4).	○	○	*2
SD8771	Message frame and form (CH4)	This register stores the message frame and form (CH4).	○	○	R
SD8772	Timeout time (CH4)	This register stores the timeout time (CH4).	○	○	R
SD8774	Message waiting time (CH4)	Message waiting time (CH4) is stored.	○	○	R
SD8800	Current retry value (CH1)	This register stores the current retry value (CH1).	×	○	R
SD8810	Current retry value (CH2)	This register stores the current retry value (CH2).	○	○	R
SD8820	Current retry value (CH3)	This register stores the current retry value (CH3).	○	○	R
SD8830	Current retry value (CH4)	This register stores the current retry value (CH4).	○	○	R
SD8861	Slave node address (CH1)	This register stores the host station number (CH1).	×	○	R
SD8862	Slave response timeout (CH1)	This register stores the slave response timeout (CH1).	×	○	R
SD8863	Turn around delay (CH1)	This register stores the broadcast delay (CH1).	×	○	R
SD8864	Message to message delay (CH1)	This register stores the request to request delay (CH1).	×	○	R
SD8865	Number of retries (CH1)	This register stores the number of retries during timeout (CH1).	×	○	R
SD8871	Slave node address (CH2)	This register stores the host station number (CH2).	○	○	R
SD8872	Slave response timeout (CH2)	This register stores the slave response timeout (CH2).	○	○	R
SD8873	Turn around delay (CH2)	This register stores the broadcast delay (CH12).	○	○	R
SD8874	Message to message delay (CH2)	This register stores the request to request delay (CH2).	○	○	R
SD8875	Number of retries (CH2)	This register stores the number of retries during timeout (CH2).	○	○	R
SD8881	Slave node address (CH3)	This register stores the host station number (CH3).	○	○	R
SD8882	Slave response timeout (CH3)	This register stores the slave response timeout (CH3).	○	○	R
SD8883	Turn around delay (CH3)	This register stores the broadcast delay (CH3).	○	○	R
SD8884	Message to message delay (CH3)	This register stores the request to request delay (CH3).	○	○	R
SD8885	Number of retries (CH3)	This register stores the number of retries during timeout (CH3).	○	○	R
SD8891	Slave node address (CH4)	This register stores the host station number (CH4).	○	○	R
SD8892	Slave response timeout (CH4)	This register stores the slave response timeout (CH4).	○	○	R
SD8893	Turn around delay (CH4)	This register stores the broadcast delay (CH4).	○	○	R
SD8894	Message to message delay (CH4)	This register stores the request to request delay (CH4).	○	○	R
SD8895	Number of retries (CH4)	This register stores the number of retries during timeout (CH4).	○	○	R
SD8921	IVBWR instruction error parameter number (CH1)	This register stores the IVBWR instruction error parameter number (CH1).	×	○	R
SD8931	IVBWR instruction error parameter number (CH2)	This register stores the IVBWR instruction error parameter number (CH2).	○	○	R
SD8941	IVBWR instruction error parameter number (CH3)	This register stores the IVBWR instruction error parameter number (CH3).	○	○	R

No.	Name	Description	Function support		R/W
			FX5UJ	FX5U/ FX5UC*1	
SD8951	IVBWR instruction error parameter number (CH4)	This register stores the IVBWR instruction error parameter number (CH4).	○	○	R
SD8981	Response wait time (CH1)	This register stores the response wait time (CH1).	×	○	R
SD8991	Response wait time (CH2)	This register stores the response wait time (CH2).	○	○	R
SD9001	Response wait time (CH3)	This register stores the response wait time (CH3).	○	○	R
SD9011	Response wait time (CH4)	This register stores the response wait time (CH4).	○	○	R
SD9040	Station number	This register stores the station number.	○	○	R
SD9041	Total number of slave stations	This register stores the total number of slave stations.	○	○	R
SD9043	Current link scan time	This register stores the current link scan time.	○	○	R
SD9044	Maximum link scan time	This register stores the maximum link scan time.	○	○	R
SD9045	Number of communication error at master station	This register stores the number of communication error at master station.	○	○	R
SD9046	Number of communication error at slave station No.1	This register stores the number of communication error at slave station No.1.	○	○	R
SD9047	Number of communication error at slave station No.2	This register stores the number of communication error at slave station No.2.	○	○	R
SD9048	Number of communication error at slave station No.3	This register stores the number of communication error at slave station No.3.	○	○	R
SD9049	Number of communication error at slave station No.4	This register stores the number of communication error at slave station No.4.	○	○	R
SD9050	Number of communication error at slave station No.5	This register stores the number of communication error at slave station No.5.	○	○	R
SD9051	Number of communication error at slave station No.6	This register stores the number of communication error at slave station No.6.	○	○	R
SD9052	Number of communication error at slave station No.7	This register stores the number of communication error at slave station No.7.	○	○	R
SD9061	Code of communication error at master station	This register stores the code of communication error at master station.	○	○	R
SD9062	Code of communication error at slave station No.1	This register stores the code of communication error at slave station No.1.	○	○	R
SD9063	Code of communication error at slave station No.2	This register stores the code of communication error at slave station No.2.	○	○	R
SD9064	Code of communication error at slave station No.3	This register stores the code of communication error at slave station No.3.	○	○	R
SD9065	Code of communication error at slave station No.4	This register stores the code of communication error at slave station No.4.	○	○	R
SD9066	Code of communication error at slave station No.5	This register stores the code of communication error at slave station No.5.	○	○	R
SD9067	Code of communication error at slave station No.6	This register stores the code of communication error at slave station No.6.	○	○	R
SD9068	Code of communication error at slave station No.7	This register stores the code of communication error at slave station No.7.	○	○	R
SD9080	Station number setting	This register stores the station number setting.	○	○	R/W
SD9081	Total slave station number setting	This register stores the total slave station number setting.	○	○	R/W
SD9082	Refresh range setting	This register stores the refresh range setting.	○	○	R
SD9083	Retry count setting	This register stores the retry count setting.	○	○	R
SD9084	Communication time-out setting	This register stores the communication time-out setting.	○	○	R
SD9090	Master station/slave station setting	The master station/slave station settings are stored.	○	○	R
SD9091	Link mode setting	The link mode settings are stored.	○	○	R
SD9092	Error determination time setting	The error determination time setting is stored.	○	○	R
SD9102	Predefined protocol ready	The reflected status after the protocol setting data has been written is stored. • 0: Normal • 1: Abnormal	○	○	R

No.	Name	Description	Function support		R/W
			FX5UJ	FX5U/ FX5UC*1	
SD9120	Predefined protocol setting data error information: Protocol No.	When a protocol setting data error was detected, information to identify the error position is stored. • 0: Normal • 1 to 64: Protocol No. • 65535: Not identifiable	○	○	R
SD9121	Predefined protocol setting data error information: Setting type	When a protocol setting data error was detected, information to identify the error position is stored. • 0: Packet setting or element setting • 1: Configuring detailed setting of protocols • 65535: Not identifiable	○	○	R
SD9122	Predefined protocol setting data error information: Packet No.	When a protocol setting data error was detected, information to identify the error position is stored. • 0: Send packet • 1: Receive packet • 65535: Not identifiable	○	○	R
SD9123	Predefined protocol setting data error information: Element No.	When a protocol setting data error was detected, information to identify the error position is stored. • 1 to 32: Element No. • 65535: Not identifiable	○	○	R
SD9124	Number of registered predefined protocols	The number of registered protocol setting data is stored. 1 to 64	○	○	R
SD9132	Predefined protocol: Protocol registration (1 to 16)	The ON/OFF state of the bit corresponding to a protocol number indicates whether the protocol setting data has been registered or not. b15 to b0: 16 to 1	○	○	R
SD9133	Predefined protocol: Protocol registration (17 to 32)	The ON/OFF state of the bit corresponding to a protocol number indicates whether the protocol setting data has been registered or not. b15 to b0: 32 to 17	○	○	R
SD9134	Predefined protocol: Protocol registration (33 to 48)	The ON/OFF state of the bit corresponding to a protocol number indicates whether the protocol setting data has been registered or not. b15 to b0: 48 to 33	○	○	R
SD9135	Predefined protocol: Protocol registration (49 to 64)	The ON/OFF state of the bit corresponding to a protocol number indicates whether the protocol setting data has been registered or not. b15 to b0: 64 to 49	○	○	R
SD9150	Protocol execution status (CH1)	The status of a protocol in execution (CH1) is stored. • 0: Unexecuted • 1: Waiting for transmission • 2: Sending • 3: Waiting for data reception • 4: Receiving • 5: Completed	×	○	R
SD9168	Protocol execution count (CH1)	The cumulative number of executions (CH1) of a protocol is stored. 0 to 65535	×	○	R
SD9169	Protocol cancel specification (CH1)	The protocol (CH1) in execution can be cancelled with a value to be stored in this area. • 0: Normally operation (do not cancel) • 1: Cancel request • 2: Cancel operation completed	×	○	R/W
SD9170	Protocol execution status (CH2)	The status of a protocol in execution (CH2) is stored. • 0: Unexecuted • 1: Waiting for transmission • 2: Sending • 3: Waiting for data reception • 4: Receiving • 5: Completed	○	○	R
SD9188	Protocol execution count (CH2)	The cumulative number of executions (CH2) of a protocol is stored. 0 to 65535	○	○	R

No.	Name	Description	Function support		R/W
			FX5UJ	FX5U/ FX5UC*1	
SD9189	Protocol cancel specification (CH2)	The protocol (CH2) in execution can be cancelled with a value to be stored in this area. • 0: Normally operation (do not cancel) • 1: Cancel request • 2: Cancel operation completed	○	○	R/W
SD9190	Protocol execution status (CH3)	The status of a protocol in execution (CH3) is stored. • 0: Unexecuted • 1: Waiting for transmission • 2: Sending • 3: Waiting for data reception • 4: Receiving • 5: Completed	○	○	R
SD9208	Protocol execution count (CH3)	The cumulative number of executions (CH3) of a protocol is stored. 0 to 65535	○	○	R
SD9209	Protocol cancel specification (CH3)	The protocol (CH3) in execution can be cancelled with a value to be stored in this area. • 0: Normally operation (do not cancel) • 1: Cancel request • 2: Cancel operation completed	○	○	R/W
SD9210	Protocol execution status (CH4)	The status of a protocol in execution (CH4) is stored. • 0: Unexecuted • 1: Waiting for transmission • 2: Sending • 3: Waiting for data reception • 4: Receiving • 5: Completed	○	○	R
SD9228	Protocol execution count (CH4)	The cumulative number of executions (CH4) of a protocol is stored. 0 to 65535	○	○	R
SD9229	Protocol cancel specification (CH4)	The protocol (CH4) in execution can be cancelled with a value to be stored in this area. • 0: Normally operation (do not cancel) • 1: Cancel request • 2: Cancel operation completed	○	○	R/W
SD9230	Send/receive data monitoring function setting (CH1)	The setting (CH1) of the send/receive data monitoring function is stored. • 0000H: Monitor stop • 0001H: Monitor start • 0002H: Monitoring (set by system) • 1002H: Monitor stop (set by system) • 100FH: Monitor setting error (set by system)	×	○	R/W
SD9231	Send/receive data monitoring function option setting (CH1)	The option setting (CH1) of the send/receive data monitoring function is stored. • b0: Data area full stop specification • b1: Packet stop specification	×	○	W
SD9232	Monitoring data device specification (CH1)	The type of word device (CH1) used as the monitor data areas is stored. • 0: D device • 1: R device • 2: W device • 3: SW device	×	○	W
SD9233	Monitoring data start device No. specification (CH1)	The start device number (CH1) of word devices used as the monitor data areas is stored. 0 to 32765	×	○	W
SD9234	Monitoring data size specification (CH1)	The size (CH1) of word devices used as the monitor data areas is stored in word units. 1 to 32765	×	○	W

No.	Name	Description	Function support		R/W
			FX5UJ	FX5U/ FX5UC*1	
SD9240	Send/receive data monitoring function setting (CH2)	The setting (CH2) of the send/receive data monitoring function is stored. <ul style="list-style-type: none"> • 0000H: Monitor stop • 0001H: Monitor start • 0002H: Monitoring (set by system) • 1002H: Monitor stop (set by system) • 100FH: Monitor setting error (set by system) 	○	○	R/W
SD9241	Send/receive data monitoring function option setting (CH2)	The option setting (CH2) of the send/receive data monitoring function is stored. <ul style="list-style-type: none"> • b0: Data area full stop specification • b1: Packet stop specification 	○	○	W
SD9242	Monitoring data device specification (CH2)	The type of word device (CH2) used as the monitor data areas is stored. <ul style="list-style-type: none"> • 0: D device • 1: R device • 2: W device • 3: SW device 	○	○	W
SD9243	Monitoring data start device No. specification (CH2)	The start device number (CH2) of word devices used as the monitor data areas is stored. 0 to 32765	○	○	W
SD9244	Monitoring data size specification (CH2)	The size (CH2) of word devices used as the monitor data areas is stored in word units. 1 to 32765	○	○	W
SD9250	Send/receive data monitoring function setting (CH3)	The setting (CH3) of the send/receive data monitoring function is stored. <ul style="list-style-type: none"> • 0000H: Monitor stop • 0001H: Monitor start • 0002H: Monitoring (set by system) • 1002H: Monitor stop (set by system) • 100FH: Monitor setting error (set by system) 	○	○	R/W
SD9251	Send/receive data monitoring function option setting (CH3)	The option setting (CH3) of the send/receive data monitoring function is stored. <ul style="list-style-type: none"> • b0: Data area full stop specification • b1: Packet stop specification 	○	○	W
SD9252	Monitoring data device specification (CH3)	The type of word device (CH3) used as the monitor data areas is stored. <ul style="list-style-type: none"> • 0: D device • 1: R device • 2: W device • 3: SW device 	○	○	W
SD9253	Monitoring data start device No. specification (CH3)	The start device number (CH3) of word devices used as the monitor data areas is stored. 0 to 32765	○	○	W
SD9254	Monitoring data size specification (CH3)	The size (CH3) of word devices used as the monitor data areas is stored in word units. 1 to 32765	○	○	W
SD9260	Send/receive data monitoring function setting (CH4)	The setting (CH4) of the send/receive data monitoring function is stored. <ul style="list-style-type: none"> • 0000H: Monitor stop • 0001H: Monitor start • 0002H: Monitoring (set by system) • 1002H: Monitor stop (set by system) • 100FH: Monitor setting error (set by system) 	○	○	R/W
SD9261	Send/receive data monitoring function option setting (CH4)	The option setting (CH4) of the send/receive data monitoring function is stored. <ul style="list-style-type: none"> • b0: Data area full stop specification • b1: Packet stop specification 	○	○	W
SD9262	Monitoring data device specification (CH4)	The type of word device (CH4) used as the monitor data areas is stored. <ul style="list-style-type: none"> • 0: D device • 1: R device • 2: W device • 3: SW device 	○	○	W

No.	Name	Description	Function support		R/W
			FX5UJ	FX5U/ FX5UC*1	
SD9263	Monitoring data start device No. specification (CH4)	The start device number (CH4) of word devices used as the monitor data areas is stored. 0 to 32765	○	○	W
SD9264	Monitoring data size specification (CH4)	The size (CH4) of word devices used as the monitor data areas is stored in word units. 1 to 32765	○	○	W

*1 CH2 devices for serial communication are not supported by FX5UC CPU module.

*2 Varies according to the host station number SD latch setting state.
Latch disabled: R, Latch enabled: R/W

Data logging function

The special registers for data logging function are shown below.

○: Supported, ×: Not supported

R: Read only, R/W: Read/Write

No.	Name	Description	Function support		R/W
			FX5UJ	FX5U/ FX5UC	
SD9300	Data logging setting No.1 Data logging register/clear error code	The cause of the error that occurred when SM9300 (Data logging register/clear flag) is ON (register)/OFF (clear) is stored. 0: No error Other than 0: Error codes	○	○	R
SD9301	Data logging setting No.2 Data logging register/clear error code	The cause of the error that occurred when SM9301 (Data logging register/clear flag) is ON (register)/OFF (clear) is stored. 0: No error Other than 0: Error codes	○	○	R
SD9302	Data logging setting No.3 Data logging register/clear error code	The cause of the error that occurred when SM9302 (Data logging register/clear flag) is ON (register)/OFF (clear) is stored. 0: No error Other than 0: Error codes	○	○	R
SD9303	Data logging setting No.4 Data logging register/clear error code	The cause of the error that occurred when SM9303 (Data logging register/clear flag) is ON (register)/OFF (clear) is stored. 0: No error Other than 0: Error codes	○	○	R

Latch area

The special registers for latch area are shown below.

○: Supported, ×: Not supported

R: Read only, R/W: Read/Write

No.	Name	Description	Function support		R/W
			FX5UJ	FX5U/ FX5UC	
SD9350	Operation mode setting	Set the operation mode of backup. 0: Normal Mode 1: CPU module auto exchange function (Deleting existing data) 2: CPU module auto exchange function (Holding existing data)	○	○	R/W
SD9351	CPU module automatic replacement function Restore target data setting	Set the target data restored with the CPU module auto exchange function. 0: Only device/label data 1: All target data 2: All target data excluding device/label data	○	○	R/W
SD9352	CPU module auto exchange function setting	Set the target data restored with the CPU module auto exchange function. <div style="text-align: center;"> b15b14 b1  </div> b1: Initialize during CPU module auto exchange function b14: Restoration for the special relay and special register (CPU module auto exchange function) b15: Setting of operation after CPU module auto exchange function	○	○	R/W

CC-Link IE Field Network Basic function

The special registers for CC-Link IE Field Network Basic function are shown below.

○: Supported, ×: Not supported

R: Read only, R/W: Read/Write

No.	Name	Description	Function support		R/W
			FX5UJ	FX5U/ FX5UC	
SD9400	CC-Link IE Field Network Basic communication interval setting	This register stores CC-Link IE Field Network Basic communication interval setting. Range: 20 to 1000 (ms)	○	○	R/W

Built-in Ethernet

The special registers for built-in Ethernet are shown below.

○: Supported, ×: Not supported

R: Read only, R/W: Read/Write

No.	Name	Description	Function support		R/W
			FX5UJ	FX5U/ FX5UC	
SD10050	Local node IP address [Low-order]	This register stores the local node IP address.	○	○	R
SD10051	Local node IP address [High-order]				
SD10060	Subnet mask [Low-order]	This register stores the subnet mask.	○	○	R
SD10061	Subnet mask [High-order]				
SD10064	Default gateway IP address [Low-order]	This register stores the default gateway IP address.	○	○	R
SD10065	Default gateway IP address [High-order]				
SD10074	Local node MAC address	This register stores the local node MAC address (5 and 6 bytes).	○	○	R
SD10075	Local node MAC address	This register stores the local node MAC address (3 and 4 bytes).	○	○	R
SD10076	Local node MAC address	This register stores the local node MAC address (1 and 2 bytes).	○	○	R
SD10082	Communication speed setting	This register stores the communication speed setting.	○	○	R
SD10084	MELSOFT connection TCP port No.	This register stores the MELSOFT connection TCP port No.	○	○	R
SD10086	MELSOFT direct connection port No.	This register stores the MELSOFT direct connection port No.	○	○	R
SD10130	Connection No.1 latest error code	This register stores the connection No.1 latest error code.	○	○	R
SD10131	Connection No.2 latest error code	This register stores the connection No.2 latest error code.	○	○	R
SD10132	Connection No.3 latest error code	This register stores the connection No.3 latest error code.	○	○	R
SD10133	Connection No.4 latest error code	This register stores the connection No.4 latest error code.	○	○	R
SD10134	Connection No.5 latest error code	This register stores the connection No.5 latest error code.	○	○	R
SD10135	Connection No.6 latest error code	This register stores the connection No.6 latest error code.	○	○	R
SD10136	Connection No.7 latest error code	This register stores the connection No.7 latest error code.	○	○	R
SD10137	Connection No.8 latest error code	This register stores the connection No.8 latest error code.	○	○	R
SD10251	Same IP address state storage area	b0: Same IP address detection flag 0: No same IP address 1: Same IP address	○	○	R
SD10252	MAC address of the already connected station	This register stores the MAC address (5 and 6 bytes) of the already connected station.	○	○	R
SD10253	MAC address of the already connected station	This register stores the MAC address (3 and 4 bytes) of the already connected station.	○	○	R
SD10254	MAC address of the already connected station	This register stores the MAC address (1 and 2 bytes) of the already connected station.	○	○	R
SD10255	MAC address of the station connected later	This register stores the MAC address (5 and 6 bytes) of the station connected later.	○	○	R
SD10256	MAC address of the station connected later	This register stores the MAC address (3 and 4 bytes) of the station connected later.	○	○	R
SD10257	MAC address of the station connected later	This register stores the MAC address (1 and 2 bytes) of the station connected later.	○	○	R

A

No.	Name	Description	Function support		R/W
			FX5UJ	FX5U/ FX5UC	
SD10270	Remote password lock status connection No. 1 to 8	b0: Connection No.1 b1: Connection No.2 b2: Connection No.3 b3: Connection No.4 b4: Connection No.5 b5: Connection No.6 b6: Connection No.7 b7: Connection No.8 0: Unlock status/remote password setting none 1: Lock status	○	○	R
SD10271	Remote password lock status system port	b2: MELSOFT application communication port (TCP) b3: MELSOFT direct connection b4: FTP transmission port 0: Unlock status/remote password setting none 1: Lock status	○	○	R
SD10290	Time setting function operation result	Stores the operation result of the time setting function. • 0000H: Unexecuted • 0001H: Success • FFFFH: Failure	○	○	R
SD10291	Time setting function execution time (Year)	The year (A.D.) which the time setting function is executed is stored in a binary code. When the communication fails, this device is not updated.	○	○	R
SD10292	Time setting function execution time (Month)	The month which the time setting function is executed is stored in a binary code. When the communication fails, this device is not updated.	○	○	R
SD10293	Time setting function execution time (Day)	The day which the time setting function is executed is stored in a binary code. When the communication fails, this device is not updated.	○	○	R
SD10294	Time setting function execution time (Hour)	The hour which the time setting function is executed is stored in a binary code. When the communication fails, this device is not updated.	○	○	R
SD10295	Time setting function execution time (Minute)	The minute which the time setting function is executed is stored in a binary code. When the communication fails, this device is not updated.	○	○	R
SD10296	Time setting function execution time (Second)	The second which the time setting function is executed is stored in a binary code. When the communication fails, this device is not updated.	○	○	R
SD10297	Time setting function execution time (Day of the week)	The day of the week which the time setting function is executed is stored in a binary code. 0: Sunday 1: Monday 2: Tuesday 3: Wednesday 4: Thursday 5: Friday 6: Saturday When the communication fails, this device is not updated.	○	○	R
SD10298	Time setting function required response time	A time required from sending the message to the SNTP server to receiving the response and setting the time to the CPU module is stored. Range: 0000H to FFFE H (Unit: ms) If the value exceeds the above range, all the values are stored as FFFFH. When the communication fails, this device is not updated.	○	○	R
SD10299	Time setting function execution	This turns ON when the time setting function is executed. This automatically turns OFF when the time setting is completed or time out occurs in communication. 0: No execution request 1: Execution requested	○	○	R/W
SD10320	Connection 1 continuous unlock failure number of times	This register stores the connection 1 continuous unlock failure number of times.	○	○	R
SD10321	Connection 2 continuous unlock failure number of times	This register stores the connection 2 continuous unlock failure number of times.	○	○	R

No.	Name	Description	Function support		R/W
			FX5UJ	FX5U/ FX5UC	
SD10322	Connection 3 continuous unlock failure number of times	This register stores the connection 3 continuous unlock failure number of times.	○	○	R
SD10323	Connection 4 continuous unlock failure number of times	This register stores the connection 4 continuous unlock failure number of times.	○	○	R
SD10324	Connection 5 continuous unlock failure number of times	This register stores the connection 5 continuous unlock failure number of times.	○	○	R
SD10325	Connection 6 continuous unlock failure number of times	This register stores the connection 6 continuous unlock failure number of times.	○	○	R
SD10326	Connection 7 continuous unlock failure number of times	This register stores the connection 7 continuous unlock failure number of times.	○	○	R
SD10327	Connection 8 continuous unlock failure number of times	This register stores the connection 8 continuous unlock failure number of times.	○	○	R
SD10338	MELSOFT communication port (TCP/IP) continuous unlock failure number of times	This register stores the MELSOFT communication port (TCP/IP) continuous unlock failure number of times.	○	○	R
SD10339	FTP transmission port (TCP/IP) continuous unlock failure count	This register stores the FTP transmission port (TCP/IP) continuous unlock failure count.	○	○	R
SD10340	MELSOFT direct connection continuous unlock failure number of times	This register stores the MELSOFT direct connection continuous unlock failure number of times.	○	○	R
SD10352, SD10353	Request to stop communication	Request contact to stop data transmission when the communication setting for the simple CPU communication is "Fixed" SD10352[b0] to [b15]: Setting No.1 to Setting No.16 SD10353[b0] to [b15]: Setting No.17 to Setting No.32 ^{*1} 0 to 1: Requested (stop request) 1 to 0: Completed (stop completion)	○	○	R/W
SD10354, SD10355	Request to restart communication	Request contact to restart data transmission when the communication setting for the simple CPU communication is "Fixed" SD10354[b0] to [b15]: Setting No.1 to Setting No.16 SD10355[b0] to [b15]: Setting No.17 to Setting No.32 ^{*1} 0 to 1: Requested (restart request) 1 to 0: Completed (restart completion)	○	○	R/W
SD10356, SD10357	Execution status flag	The data transmission/reception status of the simple CPU communication is stored for each setting number. SD10356[b0] to [b15]: Setting No.1 to Setting No.16 SD10357[b0] to [b15]: Setting No.17 to Setting No.32 ^{*1} 0: Communication stop (function not used) 1: Communicating	○	○	R
SD10358, SD10359	Preparation completion flag	The preparation completion status of the simple CPU communication is stored for each setting number. SD10358[b0] to [b15]: Setting No.1 to Setting No.16 SD10359[b0] to [b15]: Setting No.17 to Setting No.32 ^{*1} 0: Not ready (function not used) 1: Ready	○	○	R
SD10380 to SD10411	Simple CPU communication status	The simple CPU communication status is stored. SD10380: Setting No.1 to SD10395: Setting No.16 SD10396: Setting No.17 to SD10411: Setting No.32 ^{*1} 0H: Unset 1H: Preparing 3H: Communicating 4H: Communication stop 5H: Retry being executed 6H: Monitoring at error AH: Communications impossible	○	○	R
SD10412 to SD10443	Error code	The cause of the error detected in the simple CPU communication is stored. SD10412: Setting No.1 to SD10427: Setting No.16 SD10428: Setting No.17 to SD10443: Setting No.32 ^{*1} 0: No error (function not used) Other than 0: Error code The value is cleared to 0 with a clear request from the engineering tool.	○	○	R



No.	Name	Description	Function support		R/W
			FX5UJ	FX5U/ FX5UC	
SD10444 to SD10475	Execution interval (current value)	If "Fixed" is set for communication setting, the current value of the execution interval is stored. SD10444: Setting No.1 to SD10459: Setting No.16 SD10460: Setting No.17 to SD10475: Setting No.32 ^{*1} 0: Unset (function not used), communications impossible Other than 0: Execution interval (unit: ms)	○	○	R
SD10476 to SD10507	Error response code	The error response code detected by simple CPU communication is stored. SD10476: Setting No.1 to SD10591: Setting No.16 SD10492: Setting No.17 to SD10507: Setting No.32	×	○	R
SD10680	Open completion signal	b0: Connection No.1 b1: Connection No.2 b2: Connection No.3 b3: Connection No.4 b4: Connection No.5 b5: Connection No.6 b6: Connection No.7 b7: Connection No.8 0: Close/Open not completed 1: Open completed	○	○	R
SD10681	Open request signal	b0: Connection No.1 b1: Connection No.2 b2: Connection No.3 b3: Connection No.4 b4: Connection No.5 b5: Connection No.6 b6: Connection No.7 b7: Connection No.8 0: No open request 1: Open request exists	○	○	R
SD10682	Socket communications receive status signal	b0: Connection No.1 b1: Connection No.2 b2: Connection No.3 b3: Connection No.4 b4: Connection No.5 b5: Connection No.6 b6: Connection No.7 b7: Connection No.8 0: No data received 1: Data receiving completed	○	○	R
SD10683	Initial status	b0: Initial normal completion status b1: Initialization abnormal completion 0: Not completed 1: Completed	○	○	R
SD10692	Predefined protocol ready	0: Not ready 1: Ready	○	○	R
SD10710	Predefined protocol setting data error information protocol number	When a protocol setting data error is detected, stores the protocol number where the error was detected.	○	○	R
SD10711	Predefined protocol setting data error information setting type	0 is stored if an error is detected in the packet setting or element setting. 1 is stored if an error is detected in the protocol detailed setting.	○	○	R
SD10712	Predefined protocol setting data error information packet number	When an error is detected in the protocol setting data, stores the packet number that detected the error.	○	○	R
SD10713	Predefined protocol setting data error information Element number	When an error is detected in the protocol setting data, stores the element number where the error was detected.	○	○	R
SD10714	Number of registered predefined protocols	Stores the protocol number of the registered protocol setting data.	○	○	R
SD10722	Predefined protocol registration (1 to 16)	Whether protocol setting data is registered or not is stored.	○	○	R
SD10723	Predefined protocol registration (17 to 32)				
SD10724	Predefined protocol registration (33 to 48)				
SD10725	Predefined protocol registration (49 to 64)				

No.	Name	Description	Function support		R/W
			FX5UJ	FX5U/ FX5UC	
SD10740	Connection No.1 protocol execution status	Stores the status of the protocol being executed at connection No.1. 0: Unexecuted 1: Waiting for transmission 2: Sending 3: Waiting for data reception 4: Receiving 5: Execution completed	○	○	R
SD10742	Connection No.1 received data verification result (receive packet No.1)	Stores the verification results of receive packet No.1. Element No. where the verification result did not match (b0 to b7) The cause of mismatch (verification result code) (b8 to b15)	○	○	R
SD10743	Connection No.1 received data verification result (receive packet No.2)	Stores the verification results of receive packet No.2. Element No. where the verification result did not match (b0 to b7) The cause of mismatch (verification result code) (b8 to b15)	○	○	R
SD10744	Connection No.1 received data verification result (receive packet No.3)	Stores the verification results of receive packet No.3. Element No. where the verification result did not match (b0 to b7) The cause of mismatch (verification result code) (b8 to b15)	○	○	R
SD10745	Connection No.1 received data verification result (receive packet No.4)	Stores the verification results of receive packet No.4. Element No. where the verification result did not match (b0 to b7) The cause of mismatch (verification result code) (b8 to b15)	○	○	R
SD10746	Connection No.1 received data verification result (receive packet No.5)	Stores the verification results of receive packet No.5. Element No. where the verification result did not match (b0 to b7) The cause of mismatch (verification result code) (b8 to b15)	○	○	R
SD10747	Connection No.1 received data verification result (receive packet No.6)	Stores the verification results of receive packet No.6. Element No. where the verification result did not match (b0 to b7) The cause of mismatch (verification result code) (b8 to b15)	○	○	R
SD10748	Connection No.1 received data verification result (receive packet No.7)	Stores the verification results of receive packet No.7. Element No. where the verification result did not match (b0 to b7) The cause of mismatch (verification result code) (b8 to b15)	○	○	R
SD10749	Connection No.1 received data verification result (receive packet No.8)	Stores the verification results of receive packet No.8. Element No. where the verification result did not match (b0 to b7) The cause of mismatch (verification result code) (b8 to b15)	○	○	R
SD10750	Connection No.1 received data verification result (receive packet No.9)	Stores the verification results of receive packet No.9. Element No. where the verification result did not match (b0 to b7) The cause of mismatch (verification result code) (b8 to b15)	○	○	R
SD10751	Connection No.1 received data verification result (receive packet No.10)	Stores the verification results of receive packet No.10. Element No. where the verification result did not match (b0 to b7) The cause of mismatch (verification result code) (b8 to b15)	○	○	R
SD10752	Connection No.1 received data verification result (receive packet No.11)	Stores the verification results of receive packet No.11. Element No. where the verification result did not match (b0 to b7) The cause of mismatch (verification result code) (b8 to b15)	○	○	R
SD10753	Connection No.1 received data verification result (receive packet No.12)	Stores the verification results of receive packet No.12. Element No. where the verification result did not match (b0 to b7) The cause of mismatch (verification result code) (b8 to b15)	○	○	R
SD10754	Connection No.1 received data verification result (receive packet No.13)	Stores the verification results of receive packet No.13. Element No. where the verification result did not match (b0 to b7) The cause of mismatch (verification result code) (b8 to b15)	○	○	R
SD10755	Connection No.1 received data verification result (receive packet No.14)	Stores the verification results of receive packet No.14. Element No. where the verification result did not match (b0 to b7) The cause of mismatch (verification result code) (b8 to b15)	○	○	R
SD10756	Connection No.1 received data verification result (receive packet No.15)	Stores the verification results of receive packet No.15. Element No. where the verification result did not match (b0 to b7) The cause of mismatch (verification result code) (b8 to b15)	○	○	R
SD10757	Connection No.1 received data verification result (receive packet No.16)	Stores the verification results of receive packet No.16. Element No. where the verification result did not match (b0 to b7) The cause of mismatch (verification result code) (b8 to b15)	○	○	R
SD10758	Connection No.1 protocol execution count	Stores the number of protocol executions in Connection No.1. 0: Protocol not executed 1 to 65535: Number of executions	○	○	R



No.	Name	Description	Function support		R/W
			FX5UJ	FX5U/ FX5UC	
SD10759	Connection No.1 protocol cancellation specification	Cancels the protocol executed in connection No.1. 0: No cancellation instruction 1: Cancellation request (set by user) 2: Cancellation completed (set by system)	○	○	R/W
SD10760	Connection No.2 protocol execution status	Stores the status of the protocol being executed at connection No.2. 0: Unexecuted 1: Waiting for transmission 2: Sending 3: Waiting for data reception 4: Receiving 5: Execution completed	○	○	R
SD10762	Connection No.2 received data verification result (receive packet No.1)	Stores the verification results of receive packet No.1. Element No. where the verification result did not match (b0 to b7) The cause of mismatch (verification result code) (b8 to b15)	○	○	R
SD10763	Connection No.2 received data verification result (receive packet No.2)	Stores the verification results of receive packet No.2. Element No. where the verification result did not match (b0 to b7) The cause of mismatch (verification result code) (b8 to b15)	○	○	R
SD10764	Connection No.2 received data verification result (receive packet No.3)	Stores the verification results of receive packet No.3. Element No. where the verification result did not match (b0 to b7) The cause of mismatch (verification result code) (b8 to b15)	○	○	R
SD10765	Connection No.2 received data verification result (receive packet No.4)	Stores the verification results of receive packet No.4. Element No. where the verification result did not match (b0 to b7) The cause of mismatch (verification result code) (b8 to b15)	○	○	R
SD10766	Connection No.2 received data verification result (receive packet No.5)	Stores the verification results of receive packet No.5. Element No. where the verification result did not match (b0 to b7) The cause of mismatch (verification result code) (b8 to b15)	○	○	R
SD10767	Connection No.2 received data verification result (receive packet No.6)	Stores the verification results of receive packet No.6. Element No. where the verification result did not match (b0 to b7) The cause of mismatch (verification result code) (b8 to b15)	○	○	R
SD10768	Connection No.2 received data verification result (receive packet No.7)	Stores the verification results of receive packet No.7. Element No. where the verification result did not match (b0 to b7) The cause of mismatch (verification result code) (b8 to b15)	○	○	R
SD10769	Connection No.2 received data verification result (receive packet No.8)	Stores the verification results of receive packet No.8. Element No. where the verification result did not match (b0 to b7) The cause of mismatch (verification result code) (b8 to b15)	○	○	R
SD10770	Connection No.2 received data verification result (receive packet No.9)	Stores the verification results of receive packet No.9. Element No. where the verification result did not match (b0 to b7) The cause of mismatch (verification result code) (b8 to b15)	○	○	R
SD10771	Connection No.2 received data verification result (receive packet No.10)	Stores the verification results of receive packet No.10. Element No. where the verification result did not match (b0 to b7) The cause of mismatch (verification result code) (b8 to b15)	○	○	R
SD10772	Connection No.2 received data verification result (receive packet No.11)	Stores the verification results of receive packet No.11. Element No. where the verification result did not match (b0 to b7) The cause of mismatch (verification result code) (b8 to b15)	○	○	R
SD10773	Connection No.2 received data verification result (receive packet No.12)	Stores the verification results of receive packet No.12. Element No. where the verification result did not match (b0 to b7) The cause of mismatch (verification result code) (b8 to b15)	○	○	R
SD10774	Connection No.2 received data verification result (receive packet No.13)	Stores the verification results of receive packet No.13. Element No. where the verification result did not match (b0 to b7) The cause of mismatch (verification result code) (b8 to b15)	○	○	R
SD10775	Connection No.2 received data verification result (receive packet No.14)	Stores the verification results of receive packet No.14. Element No. where the verification result did not match (b0 to b7) The cause of mismatch (verification result code) (b8 to b15)	○	○	R
SD10776	Connection No.2 received data verification result (receive packet No.15)	Stores the verification results of receive packet No.15. Element No. where the verification result did not match (b0 to b7) The cause of mismatch (verification result code) (b8 to b15)	○	○	R
SD10777	Connection No.2 received data verification result (receive packet No.16)	Stores the verification results of receive packet No.16. Element No. where the verification result did not match (b0 to b7) The cause of mismatch (verification result code) (b8 to b15)	○	○	R

No.	Name	Description	Function support		R/W
			FX5UJ	FX5U/ FX5UC	
SD10778	Connection No.2 protocol execution count	Stores the number of protocol executions in connection No.2. 0: Protocol not executed 1 to 65535: Number of executions	○	○	R
SD10779	Connection No.2 protocol cancellation specification	Cancels the protocol executed in connection No.2. 0: No cancellation instruction 1: Cancellation request (set by user) 2: Cancellation completed (set by system)	○	○	R/W
SD10780	Connection No.3 protocol execution status	Stores the status of the protocol being executed at connection No.3. 0: Unexecuted 1: Waiting for transmission 2: Sending 3: Waiting for data reception 4: Receiving 5: Execution completed	○	○	R
SD10782	Connection No.3 received data verification result (receive packet No.1)	Stores the verification results of receive packet No.1. Element No. where the verification result did not match (b0 to b7) The cause of mismatch (verification result code) (b8 to b15)	○	○	R
SD10783	Connection No.3 received data verification result (receive packet No.2)	Stores the verification results of receive packet No.2. Element No. where the verification result did not match (b0 to b7) The cause of mismatch (verification result code) (b8 to b15)	○	○	R
SD10784	Connection No.3 received data verification result (receive packet No.3)	Stores the verification results of receive packet No.3. Element No. where the verification result did not match (b0 to b7) The cause of mismatch (verification result code) (b8 to b15)	○	○	R
SD10785	Connection No.3 received data verification result (receive packet No.4)	Stores the verification results of receive packet No.4. Element No. where the verification result did not match (b0 to b7) The cause of mismatch (verification result code) (b8 to b15)	○	○	R
SD10786	Connection No.3 received data verification result (receive packet No.5)	Stores the verification results of receive packet No.5. Element No. where the verification result did not match (b0 to b7) The cause of mismatch (verification result code) (b8 to b15)	○	○	R
SD10787	Connection No.3 received data verification result (receive packet No.6)	Stores the verification results of receive packet No.6. Element No. where the verification result did not match (b0 to b7) The cause of mismatch (verification result code) (b8 to b15)	○	○	R
SD10788	Connection No.3 received data verification result (receive packet No.7)	Stores the verification results of receive packet No.7. Element No. where the verification result did not match (b0 to b7) The cause of mismatch (verification result code) (b8 to b15)	○	○	R
SD10789	Connection No.3 received data verification result (receive packet No.8)	Stores the verification results of receive packet No.8. Element No. where the verification result did not match (b0 to b7) The cause of mismatch (verification result code) (b8 to b15)	○	○	R
SD10790	Connection No.3 received data verification result (receive packet No.9)	Stores the verification results of receive packet No.9. Element No. where the verification result did not match (b0 to b7) The cause of mismatch (verification result code) (b8 to b15)	○	○	R
SD10791	Connection No.3 received data verification result (receive packet No.10)	Stores the verification results of receive packet No.10. Element No. where the verification result did not match (b0 to b7) The cause of mismatch (verification result code) (b8 to b15)	○	○	R
SD10792	Connection No.3 received data verification result (receive packet No.11)	Stores the verification results of receive packet No.11. Element No. where the verification result did not match (b0 to b7) The cause of mismatch (verification result code) (b8 to b15)	○	○	R
SD10793	Connection No.3 received data verification result (receive packet No.12)	Stores the verification results of receive packet No.12. Element No. where the verification result did not match (b0 to b7) The cause of mismatch (verification result code) (b8 to b15)	○	○	R
SD10794	Connection No.3 received data verification result (receive packet No.13)	Stores the verification results of receive packet No.13. Element No. where the verification result did not match (b0 to b7) The cause of mismatch (verification result code) (b8 to b15)	○	○	R
SD10795	Connection No.3 received data verification result (receive packet No.14)	Stores the verification results of receive packet No.14. Element No. where the verification result did not match (b0 to b7) The cause of mismatch (verification result code) (b8 to b15)	○	○	R
SD10796	Connection No.3 received data verification result (receive packet No.15)	Stores the verification results of receive packet No.15. Element No. where the verification result did not match (b0 to b7) The cause of mismatch (verification result code) (b8 to b15)	○	○	R



No.	Name	Description	Function support		R/W
			FX5UJ	FX5U/ FX5UC	
SD10797	Connection No.3 received data verification result (receive packet No.16)	Stores the verification results of receive packet No.16. Element No. where the verification result did not match (b0 to b7) The cause of mismatch (verification result code) (b8 to b15)	○	○	R
SD10798	Connection No.3 protocol execution count	Stores the number of protocol executions in connection No.3. 0: Protocol not executed 1 to 65535: Number of executions	○	○	R
SD10799	Connection No.3 protocol cancellation specification	Cancels the protocol executed in connection No.3. 0: No cancellation instruction 1: Cancellation request (set by user) 2: Cancellation completed (set by system)	○	○	R/W
SD10800	Connection No.4 protocol execution status	Stores the status of the protocol being executed at connection No.4. 0: Unexecuted 1: Waiting for transmission 2: Sending 3: Waiting for data reception 4: Receiving 5: Execution completed	○	○	R
SD10802	Connection No.4 received data verification result (receive packet No.1)	Stores the verification results of receive packet No.1. Element No. where the verification result did not match (b0 to b7) The cause of mismatch (verification result code) (b8 to b15)	○	○	R
SD10803	Connection No.4 received data verification result (receive packet No.2)	Stores the verification results of receive packet No.2. Element No. where the verification result did not match (b0 to b7) The cause of mismatch (verification result code) (b8 to b15)	○	○	R
SD10804	Connection No.4 received data verification result (receive packet No.3)	Stores the verification results of receive packet No.3. Element No. where the verification result did not match (b0 to b7) The cause of mismatch (verification result code) (b8 to b15)	○	○	R
SD10805	Connection No.4 received data verification result (receive packet No.4)	Stores the verification results of receive packet No.4. Element No. where the verification result did not match (b0 to b7) The cause of mismatch (verification result code) (b8 to b15)	○	○	R
SD10806	Connection No.4 received data verification result (receive packet No.5)	Stores the verification results of receive packet No.5. Element No. where the verification result did not match (b0 to b7) The cause of mismatch (verification result code) (b8 to b15)	○	○	R
SD10807	Connection No.4 received data verification result (receive packet No.6)	Stores the verification results of receive packet No.6. Element No. where the verification result did not match (b0 to b7) The cause of mismatch (verification result code) (b8 to b15)	○	○	R
SD10808	Connection No.4 received data verification result (receive packet No.7)	Stores the verification results of receive packet No.7. Element No. where the verification result did not match (b0 to b7) The cause of mismatch (verification result code) (b8 to b15)	○	○	R
SD10809	Connection No.4 received data verification result (receive packet No.8)	Stores the verification results of receive packet No.8. Element No. where the verification result did not match (b0 to b7) The cause of mismatch (verification result code) (b8 to b15)	○	○	R
SD10810	Connection No.4 received data verification result (receive packet No.9)	Stores the verification results of receive packet No.9. Element No. where the verification result did not match (b0 to b7) The cause of mismatch (verification result code) (b8 to b15)	○	○	R
SD10811	Connection No.4 received data verification result (receive packet No.10)	Stores the verification results of receive packet No.10. Element No. where the verification result did not match (b0 to b7) The cause of mismatch (verification result code) (b8 to b15)	○	○	R
SD10812	Connection No.4 received data verification result (receive packet No.11)	Stores the verification results of receive packet No.11. Element No. where the verification result did not match (b0 to b7) The cause of mismatch (verification result code) (b8 to b15)	○	○	R
SD10813	Connection No.4 received data verification result (receive packet No.12)	Stores the verification results of receive packet No.12. Element No. where the verification result did not match (b0 to b7) The cause of mismatch (verification result code) (b8 to b15)	○	○	R
SD10814	Connection No.4 received data verification result (receive packet No.13)	Stores the verification results of receive packet No.13. Element No. where the verification result did not match (b0 to b7) The cause of mismatch (verification result code) (b8 to b15)	○	○	R
SD10815	Connection No.4 received data verification result (receive packet No.14)	Stores the verification results of receive packet No.14. Element No. where the verification result did not match (b0 to b7) The cause of mismatch (verification result code) (b8 to b15)	○	○	R

No.	Name	Description	Function support		R/W
			FX5UJ	FX5U/ FX5UC	
SD10816	Connection No.4 received data verification result (receive packet No.15)	Stores the verification results of receive packet No.15. Element No. where the verification result did not match (b0 to b7) The cause of mismatch (verification result code) (b8 to b15)	○	○	R
SD10817	Connection No.4 received data verification result (receive packet No.16)	Stores the verification results of receive packet No.16. Element No. where the verification result did not match (b0 to b7) The cause of mismatch (verification result code) (b8 to b15)	○	○	R
SD10818	Connection No.4 protocol execution count	Stores the number of protocol executions in connection No.4. 0: Protocol not executed 1 to 65535: Number of executions	○	○	R
SD10819	Connection No.4 protocol cancellation specification	Cancels the protocol executed in connection No.4. 0: No cancellation instruction 1: Cancellation request (set by user) 2: Cancellation completed (set by system)	○	○	R/W
SD10820	Connection No.5 protocol execution status	Stores the status of the protocol being executed at connection No.5. 0: Unexecuted 1: Waiting for transmission 2: Sending 3: Waiting for data reception 4: Receiving 5: Execution completed	○	○	R
SD10822	Connection No.5 received data verification result (receive packet No.1)	Stores the verification results of receive packet No.1. Element No. where the verification result did not match (b0 to b7) The cause of mismatch (verification result code) (b8 to b15)	○	○	R
SD10823	Connection No.5 received data verification result (receive packet No.2)	Stores the verification results of receive packet No.2. Element No. where the verification result did not match (b0 to b7) The cause of mismatch (verification result code) (b8 to b15)	○	○	R
SD10824	Connection No.5 received data verification result (receive packet No.3)	Stores the verification results of receive packet No.3. Element No. where the verification result did not match (b0 to b7) The cause of mismatch (verification result code) (b8 to b15)	○	○	R
SD10825	Connection No.5 received data verification result (receive packet No.4)	Stores the verification results of receive packet No.4. Element No. where the verification result did not match (b0 to b7) The cause of mismatch (verification result code) (b8 to b15)	○	○	R
SD10826	Connection No.5 received data verification result (receive packet No.5)	Stores the verification results of receive packet No.5. Element No. where the verification result did not match (b0 to b7) The cause of mismatch (verification result code) (b8 to b15)	○	○	R
SD10827	Connection No.5 received data verification result (receive packet No.6)	Stores the verification results of receive packet No.6. Element No. where the verification result did not match (b0 to b7) The cause of mismatch (verification result code) (b8 to b15)	○	○	R
SD10828	Connection No.5 received data verification result (receive packet No.7)	Stores the verification results of receive packet No.7. Element No. where the verification result did not match (b0 to b7) The cause of mismatch (verification result code) (b8 to b15)	○	○	R
SD10829	Connection No.5 received data verification result (receive packet No.8)	Stores the verification results of receive packet No.8. Element No. where the verification result did not match (b0 to b7) The cause of mismatch (verification result code) (b8 to b15)	○	○	R
SD10830	Connection No.5 received data verification result (receive packet No.9)	Stores the verification results of receive packet No.9. Element No. where the verification result did not match (b0 to b7) The cause of mismatch (verification result code) (b8 to b15)	○	○	R
SD10831	Connection No.5 received data verification result (receive packet No.10)	Stores the verification results of receive packet No.10. Element No. where the verification result did not match (b0 to b7) The cause of mismatch (verification result code) (b8 to b15)	○	○	R
SD10832	Connection No.5 received data verification result (receive packet No.11)	Stores the verification results of receive packet No.11. Element No. where the verification result did not match (b0 to b7) The cause of mismatch (verification result code) (b8 to b15)	○	○	R
SD10833	Connection No.5 received data verification result (receive packet No.12)	Stores the verification results of receive packet No.12. Element No. where the verification result did not match (b0 to b7) The cause of mismatch (verification result code) (b8 to b15)	○	○	R
SD10834	Connection No.5 received data verification result (receive packet No.13)	Stores the verification results of receive packet No.13. Element No. where the verification result did not match (b0 to b7) The cause of mismatch (verification result code) (b8 to b15)	○	○	R

No.	Name	Description	Function support		R/W
			FX5UJ	FX5U/ FX5UC	
SD10835	Connection No.5 received data verification result (receive packet No.14)	Stores the verification results of receive packet No.14. Element No. where the verification result did not match (b0 to b7) The cause of mismatch (verification result code) (b8 to b15)	○	○	R
SD10836	Connection No.5 received data verification result (receive packet No.15)	Stores the verification results of receive packet No.15. Element No. where the verification result did not match (b0 to b7) The cause of mismatch (verification result code) (b8 to b15)	○	○	R
SD10837	Connection No.5 received data verification result (receive packet No.16)	Stores the verification results of receive packet No.16. Element No. where the verification result did not match (b0 to b7) The cause of mismatch (verification result code) (b8 to b15)	○	○	R
SD10838	Connection No.5 protocol execution count	Stores the number of protocol executions in connection No.5. 0: Protocol not executed 1 to 65535: Number of executions	○	○	R
SD10839	Connection No.5 protocol cancellation specification	Cancels the protocol executed in connection No.5. 0: No cancellation instruction 1: Cancellation request (set by user) 2: Cancellation completed (set by system)	○	○	R/W
SD10840	Connection No.6 protocol execution status	Stores the status of the protocol being executed at connection No.6. 0: Unexecuted 1: Waiting for transmission 2: Sending 3: Waiting for data reception 4: Receiving 5: Execution completed	○	○	R
SD10842	Connection No.6 received data verification result (receive packet No.1)	Stores the verification results of receive packet No.1. Element No. where the verification result did not match (b0 to b7) The cause of mismatch (verification result code) (b8 to b15)	○	○	R
SD10843	Connection No.6 received data verification result (receive packet No.2)	Stores the verification results of receive packet No.2. Element No. where the verification result did not match (b0 to b7) The cause of mismatch (verification result code) (b8 to b15)	○	○	R
SD10844	Connection No.6 received data verification result (receive packet No.3)	Stores the verification results of receive packet No.3. Element No. where the verification result did not match (b0 to b7) The cause of mismatch (verification result code) (b8 to b15)	○	○	R
SD10845	Connection No.6 received data verification result (receive packet No.4)	Stores the verification results of receive packet No.4. Element No. where the verification result did not match (b0 to b7) The cause of mismatch (verification result code) (b8 to b15)	○	○	R
SD10846	Connection No.6 received data verification result (receive packet No.5)	Stores the verification results of receive packet No.5. Element No. where the verification result did not match (b0 to b7) The cause of mismatch (verification result code) (b8 to b15)	○	○	R
SD10847	Connection No.6 received data verification result (receive packet No.6)	Stores the verification results of receive packet No.6. Element No. where the verification result did not match (b0 to b7) The cause of mismatch (verification result code) (b8 to b15)	○	○	R
SD10848	Connection No.6 received data verification result (receive packet No.7)	Stores the verification results of receive packet No.7. Element No. where the verification result did not match (b0 to b7) The cause of mismatch (verification result code) (b8 to b15)	○	○	R
SD10849	Connection No.6 received data verification result (receive packet No.8)	Stores the verification results of receive packet No.8. Element No. where the verification result did not match (b0 to b7) The cause of mismatch (verification result code) (b8 to b15)	○	○	R
SD10850	Connection No.6 received data verification result (receive packet No.9)	Stores the verification results of receive packet No.9. Element No. where the verification result did not match (b0 to b7) The cause of mismatch (verification result code) (b8 to b15)	○	○	R
SD10851	Connection No.6 received data verification result (receive packet No.10)	Stores the verification results of receive packet No.10. Element No. where the verification result did not match (b0 to b7) The cause of mismatch (verification result code) (b8 to b15)	○	○	R
SD10852	Connection No.6 received data verification result (receive packet No.11)	Stores the verification results of receive packet No.11. Element No. where the verification result did not match (b0 to b7) The cause of mismatch (verification result code) (b8 to b15)	○	○	R
SD10853	Connection No.6 received data verification result (receive packet No.12)	Stores the verification results of receive packet No.12. Element No. where the verification result did not match (b0 to b7) The cause of mismatch (verification result code) (b8 to b15)	○	○	R

No.	Name	Description	Function support		R/W
			FX5UJ	FX5U/ FX5UC	
SD10854	Connection No.6 received data verification result (receive packet No.13)	Stores the verification results of receive packet No.13. Element No. where the verification result did not match (b0 to b7) The cause of mismatch (verification result code) (b8 to b15)	○	○	R
SD10855	Connection No.6 received data verification result (receive packet No.14)	Stores the verification results of receive packet No.14. Element No. where the verification result did not match (b0 to b7) The cause of mismatch (verification result code) (b8 to b15)	○	○	R
SD10856	Connection No.6 received data verification result (receive packet No.15)	Stores the verification results of receive packet No.15. Element No. where the verification result did not match (b0 to b7) The cause of mismatch (verification result code) (b8 to b15)	○	○	R
SD10857	Connection No.6 received data verification result (receive packet No.16)	Stores the verification results of receive packet No.16. Element No. where the verification result did not match (b0 to b7) The cause of mismatch (verification result code) (b8 to b15)	○	○	R
SD10858	Connection No.6 protocol execution count	Stores the number of protocol executions in connection No.6. 0: Protocol not executed 1 to 65535: Number of executions	○	○	R
SD10859	Connection No.6 protocol cancellation specification	Cancels the protocol executed in connection No.6. 0: No cancellation instruction 1: Cancellation request (set by user) 2: Cancellation completed (set by system)	○	○	R/W
SD10860	Connection No.7 protocol execution status	Stores the status of the protocol being executed at connection No.7. 0: Unexecuted 1: Waiting for transmission 2: Sending 3: Waiting for data reception 4: Receiving 5: Execution completed	○	○	R
SD10862	Connection No.7 received data verification result (receive packet No.1)	Stores the verification results of receive packet No.1. Element No. where the verification result did not match (b0 to b7) The cause of mismatch (verification result code) (b8 to b15)	○	○	R
SD10863	Connection No.7 received data verification result (receive packet No.2)	Stores the verification results of receive packet No.2. Element No. where the verification result did not match (b0 to b7) The cause of mismatch (verification result code) (b8 to b15)	○	○	R
SD10864	Connection No.7 received data verification result (receive packet No.3)	Stores the verification results of receive packet No.3. Element No. where the verification result did not match (b0 to b7) The cause of mismatch (verification result code) (b8 to b15)	○	○	R
SD10865	Connection No.7 received data verification result (receive packet No.4)	Stores the verification results of receive packet No.4. Element No. where the verification result did not match (b0 to b7) The cause of mismatch (verification result code) (b8 to b15)	○	○	R
SD10866	Connection No.7 received data verification result (receive packet No.5)	Stores the verification results of receive packet No.5. Element No. where the verification result did not match (b0 to b7) The cause of mismatch (verification result code) (b8 to b15)	○	○	R
SD10867	Connection No.7 received data verification result (receive packet No.6)	Stores the verification results of receive packet No.6. Element No. where the verification result did not match (b0 to b7) The cause of mismatch (verification result code) (b8 to b15)	○	○	R
SD10868	Connection No.7 received data verification result (receive packet No.7)	Stores the verification results of receive packet No.7. Element No. where the verification result did not match (b0 to b7) The cause of mismatch (verification result code) (b8 to b15)	○	○	R
SD10869	Connection No.7 received data verification result (receive packet No.8)	Stores the verification results of receive packet No.8. Element No. where the verification result did not match (b0 to b7) The cause of mismatch (verification result code) (b8 to b15)	○	○	R
SD10870	Connection No.7 received data verification result (receive packet No.9)	Stores the verification results of receive packet No.9. Element No. where the verification result did not match (b0 to b7) The cause of mismatch (verification result code) (b8 to b15)	○	○	R
SD10871	Connection No.7 received data verification result (receive packet No.10)	Stores the verification results of receive packet No.10. Element No. where the verification result did not match (b0 to b7) The cause of mismatch (verification result code) (b8 to b15)	○	○	R
SD10872	Connection No.7 received data verification result (receive packet No.11)	Stores the verification results of receive packet No.11. Element No. where the verification result did not match (b0 to b7) The cause of mismatch (verification result code) (b8 to b15)	○	○	R



No.	Name	Description	Function support		R/W
			FX5UJ	FX5U/ FX5UC	
SD10873	Connection No.7 received data verification result (receive packet No.12)	Stores the verification results of receive packet No.12. Element No. where the verification result did not match (b0 to b7) The cause of mismatch (verification result code) (b8 to b15)	○	○	R
SD10874	Connection No.7 received data verification result (receive packet No.13)	Stores the verification results of receive packet No.13. Element No. where the verification result did not match (b0 to b7) The cause of mismatch (verification result code) (b8 to b15)	○	○	R
SD10875	Connection No.7 received data verification result (receive packet No.14)	Stores the verification results of receive packet No.14. Element No. where the verification result did not match (b0 to b7) The cause of mismatch (verification result code) (b8 to b15)	○	○	R
SD10876	Connection No.7 received data verification result (receive packet No.15)	Stores the verification results of receive packet No.15. Element No. where the verification result did not match (b0 to b7) The cause of mismatch (verification result code) (b8 to b15)	○	○	R
SD10877	Connection No.7 received data verification result (receive packet No.16)	Stores the verification results of receive packet No.16. Element No. where the verification result did not match (b0 to b7) The cause of mismatch (verification result code) (b8 to b15)	○	○	R
SD10878	Connection No.7 protocol execution count	Stores the number of protocol executions in connection No.7. 0: Protocol not executed 1 to 65535: Number of executions	○	○	R
SD10879	Connection No.7 protocol cancellation specification	Cancels the protocol executed in connection No.7. 0: No cancellation instruction 1: Cancellation request (set by user) 2: Cancellation completed (set by system)	○	○	R/W
SD10880	Connection No.8 protocol execution status	Stores the status of the protocol being executed at connection No.8. 0: Unexecuted 1: Waiting for transmission 2: Sending 3: Waiting for data reception 4: Receiving 5: Execution completed	○	○	R
SD10882	Connection No.8 received data verification result (receive packet No.1)	Stores the verification results of receive packet No.1. Element No. where the verification result did not match (b0 to b7) The cause of mismatch (verification result code) (b8 to b15)	○	○	R
SD10883	Connection No.8 received data verification result (receive packet No.2)	Stores the verification results of receive packet No.2. Element No. where the verification result did not match (b0 to b7) The cause of mismatch (verification result code) (b8 to b15)	○	○	R
SD10884	Connection No.8 received data verification result (receive packet No.3)	Stores the verification results of receive packet No.3. Element No. where the verification result did not match (b0 to b7) The cause of mismatch (verification result code) (b8 to b15)	○	○	R
SD10885	Connection No.8 received data verification result (receive packet No.4)	Stores the verification results of receive packet No.4. Element No. where the verification result did not match (b0 to b7) The cause of mismatch (verification result code) (b8 to b15)	○	○	R
SD10886	Connection No.8 received data verification result (receive packet No.5)	Stores the verification results of receive packet No.5. Element No. where the verification result did not match (b0 to b7) The cause of mismatch (verification result code) (b8 to b15)	○	○	R
SD10887	Connection No.8 received data verification result (receive packet No.6)	Stores the verification results of receive packet No.6. Element No. where the verification result did not match (b0 to b7) The cause of mismatch (verification result code) (b8 to b15)	○	○	R
SD10888	Connection No.8 received data verification result (receive packet No.7)	Stores the verification results of receive packet No.7. Element No. where the verification result did not match (b0 to b7) The cause of mismatch (verification result code) (b8 to b15)	○	○	R
SD10889	Connection No.8 received data verification result (receive packet No.8)	Stores the verification results of receive packet No.8. Element No. where the verification result did not match (b0 to b7) The cause of mismatch (verification result code) (b8 to b15)	○	○	R
SD10890	Connection No.8 received data verification result (receive packet No.9)	Stores the verification results of receive packet No.9. Element No. where the verification result did not match (b0 to b7) The cause of mismatch (verification result code) (b8 to b15)	○	○	R
SD10891	Connection No.8 received data verification result (receive packet No.10)	Stores the verification results of receive packet No.10. Element No. where the verification result did not match (b0 to b7) The cause of mismatch (verification result code) (b8 to b15)	○	○	R

No.	Name	Description	Function support		R/W
			FX5UJ	FX5U/ FX5UC	
SD10892	Connection No.8 received data verification result (receive packet No.11)	Stores the verification results of receive packet No.11. Element No. where the verification result did not match (b0 to b7) The cause of mismatch (verification result code) (b8 to b15)	○	○	R
SD10893	Connection No.8 received data verification result (receive packet No.12)	Stores the verification results of receive packet No.12. Element No. where the verification result did not match (b0 to b7) The cause of mismatch (verification result code) (b8 to b15)	○	○	R
SD10894	Connection No.8 received data verification result (receive packet No.13)	Stores the verification results of receive packet No.13. Element No. where the verification result did not match (b0 to b7) The cause of mismatch (verification result code) (b8 to b15)	○	○	R
SD10895	Connection No.8 received data verification result (receive packet No.14)	Stores the verification results of receive packet No.14. Element No. where the verification result did not match (b0 to b7) The cause of mismatch (verification result code) (b8 to b15)	○	○	R
SD10896	Connection No.8 received data verification result (receive packet No.15)	Stores the verification results of receive packet No.15. Element No. where the verification result did not match (b0 to b7) The cause of mismatch (verification result code) (b8 to b15)	○	○	R
SD10897	Connection No.8 received data verification result (receive packet No.16)	Stores the verification results of receive packet No.16. Element No. where the verification result did not match (b0 to b7) The cause of mismatch (verification result code) (b8 to b15)	○	○	R
SD10898	Connection No.8 protocol execution count	Stores the number of protocol executions in connection No.8. 0: Protocol not executed 1 to 65535: Number of executions	○	○	R
SD10899	Connection No.8 protocol cancellation specification	Cancels the protocol executed in connection No.8. 0: No cancellation instruction 1: Cancellation request (set by user) 2: Cancellation completed (set by system)	○	○	R/W

*1 Only FX5U/FX5UC CPU module is supported.

CC-Link IE Field Network Basic function

The special registers for CC-Link IE Field Network Basic function are shown below.

○: Supported, ×: Not supported

R: Read only, R/W: Read/Write

No.	Name	Description	Function support		R/W
			FX5UJ	FX5U/ FX5UC	
SD11100	Total number of connected stations	The total number of connected stations set in parameter is stored. Range • FX5UJ CPU module: 1 to 8 • FX5U/FX5UC CPU module: 1 to 16	○	○	R
SD11101	Reserved station specification status	The reserved station specification status of the slave station specified in parameter is stored. (0: Not specified, 1: Specified) <div style="text-align: right; margin-right: 20px;">b0</div> <div style="border: 1px solid black; width: 100px; height: 15px; margin: 0 auto;"></div> b0: Reserved station specification status b1 to b15: Empty (fixed to 0) The station number that is specified as a reserved station can be checked in 'Reserved station specification status of each station' (SD11102).	○	○	R
SD11102	Reserved station specification status of each station	The reserved station specification status is stored using the following bit pattern. (Off: Other than the reserved station, On: Reserved station) <div style="text-align: right; margin-right: 20px;">b5 b4 b3 b2 b1 b0</div> <div style="border: 1px solid black; width: 100px; height: 15px; margin: 0 auto; display: flex; justify-content: space-between;"> 654321 </div> The numbers in the figure indicate station numbers. (Target) • FX5UJ CPU module: b7 to b0 • FX5U/FX5UC CPU module: b15 to b0 (Condition) • Only the bit of the start station number turns on. • The status is not stored for the station numbers after the maximum station number.	○	○	R

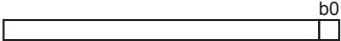
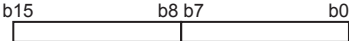
No.	Name	Description	Function support		R/W
			FX5UJ	FX5U/ FX5UC	
SD11106	Maximum link scan (unit: ms)	The maximum link scan time value during cyclic transmission is stored. (Unit: ms)	○	○	R
SD11107	Minimum link scan (unit: ms)	The minimum link scan time value during cyclic transmission is stored. (Unit: ms)	○	○	R
SD11108	Current link scan (unit: ms)	The current link scan time value during cyclic transmission is stored. (Unit: ms)	○	○	R
SD11126	Diagnostic information display request	<p>After the END instruction of the scan where the bit 0 is turned off and on is executed, the diagnostic information of a slave station specified in 'Diagnostic request information' (SD11127) is read to SD11128 to SD11153.</p> <p>When reading of the diagnostic information has completed at END processing, 0 is stored.</p>  <p>b0: Diagnostic information display request b1 to b15: Empty (fixed to 0)</p>	○	○	R/W
SD11127	Diagnosis request information	<p>Specify a slave station number whose diagnostic information is to be displayed.</p> <p>Range</p> <ul style="list-style-type: none"> • FX5UJ CPU module: 1 to 8 • FX5U/FX5UC CPU module: 1 to 16 	○	○	R/W
SD11128	Diagnostic information status flag	<p>After the END instruction of the scan where the bit 0 of 'Diagnostic information display request' (SD11126) is turned off and on is executed, the status (valid or invalid) of diagnostic information (Diagnostic information 1, Diagnostic information 2) of the slave station specified in 'Diagnostic request information' (SD11127) is stored. (Valid: 1, Invalid: 0)</p>  <p>b0 to b7: Diagnostic information 1 b8 to b15: Diagnostic information 2</p> <ul style="list-style-type: none"> • If the station number of the slave station that is specified in 'Diagnostic request information' (SD11127) is the start station number of the occupied stations and the cyclic transmission is performed for the slave station, 1 is stored in b0 to b7 and b8 to b15. (If the specified slave station is a reserved station, 0 is stored in b8 to b15.) • If the station number of the slave station that is specified in 'Diagnostic request information' (SD11127) is other than the start station number of the occupied stations or the cyclic transmission is not performed for the slave station, 0 is stored in b0 to b7 and b8 to b15. • When b0 to b7 are valid, the number of occupied stations, group number, IP address, the accumulated number of timeouts, and the accumulated number of disconnection detection are stored in 'Diagnostic request information 1' (SD11129 to SD11140). When invalid, 0 is stored in 'Diagnostic request information 1' (SD11129 to SD11140). • When b8 to b15 are valid, the Manufacturer code, Model code, device version, module information, error code, and detailed module information are stored in 'Diagnostic request information 2' (SD11144 to SD11153). When invalid, 0 is stored in 'Diagnostic request information 2' (SD11144 to SD11153). 	○	○	R/W

No.	Name	Description	Function support		R/W									
			FX5UJ	FX5U/ FX5UC										
SD11129 to SD11140	Diagnostic information 1	<p>When 1 (valid) is stored in b0 to b7 of SD11128, the number of occupied stations, group number, IP address, the accumulated number of timeouts, and the accumulated number of disconnection detection are stored. When 0 (invalid) is stored in b0 to b7 of SD11128, 0 is stored.</p> <ul style="list-style-type: none"> ■SD11129: Number of occupied stations ■SD11130: Group number ■SD11131: IP address (lower) ■SD11132: IP address (upper) <table border="1" style="margin-left: 40px;"> <tr> <td></td> <td style="text-align: center;">b15···b8</td> <td style="text-align: center;">b7···b0</td> </tr> <tr> <td>SD11131</td> <td style="text-align: center;">3</td> <td style="text-align: center;">4</td> </tr> <tr> <td>SD11132</td> <td style="text-align: center;">1</td> <td style="text-align: center;">2</td> </tr> </table> <p>1 to 4: First octet to fourth octet</p> <p>When the IP address has not been set in the parameter, 0 is stored.</p> <ul style="list-style-type: none"> ■SD11139: Accumulated number of timeouts <p>After the END instruction of the scan where the bit 0 of 'Diagnostic information display request' (SD11126) is turned off and on is executed, the accumulated number of timeouts that occurred in a slave station specified in 'Diagnostic request information' (SD11127) is stored.</p> <ul style="list-style-type: none"> • 0: No timeouts • 1 to 65535: Number of timeouts (accumulated number)*1 <ul style="list-style-type: none"> ■SD11140: Accumulated number of disconnection detection <p>After the END instruction of the scan where the bit 0 of 'Diagnostic information display request' (SD11126) is turned off and on is executed, the accumulated number of disconnections that detected in a slave station specified in 'Diagnostic request information' (SD11127) is stored.</p> <ul style="list-style-type: none"> • 0: No disconnections • 1 to 65535: Number of disconnection detection (accumulated number)*1 		b15···b8	b7···b0	SD11131	3	4	SD11132	1	2	○	○	R
	b15···b8	b7···b0												
SD11131	3	4												
SD11132	1	2												
SD11144 to SD11153	Diagnostic information 2	<p>When Diagnostic information 2 is valid (1 is stored in b8 to b15 of SD11128), the manufacturer code, model code, device version, module information, error code, and detailed module information are stored. When Diagnostic information 2 is invalid (0 is stored in b8 to b15 of SD11128), 0 is stored.</p> <ul style="list-style-type: none"> ■SD11144: Manufacturer code ■SD11146: Model code (lower) ■SD11147: Model code (upper) ■SD11148: Device version ■SD11150: Module information ■SD11151: Error code ■SD11152: Detailed module information (lower) ■SD11153: Detailed module information (upper) 	○	○	R									

*1 When the count exceeds 65535, counting is continued from 1 again.



Appendix 3 Error Code

The CPU module stores error code in special register (SD) upon detection of an error using the self-diagnostics function. The error details and cause can be identified by checking the error code. The error code can be checked in either of the following ways.

- Module diagnostics of engineering tool (📖 MELSEC iQ-F FX5 User's Manual (Startup))
- Special register (SD0 (latest self-diagnostics error code), SD10 to SD25 (self-diagnostics error code)) (📖 Page 410 Special Register List)

This section describes errors that may occur in the CPU module and actions to be taken for the errors.

Error code system

All error codes are given in hexadecimal format (4 digits) (16-bit unsigned integer). The following table lists the error detection type and the error code ranges.

Error detection type		Range	Description
By the self-diagnostic function of each module	Minor error	1000H to 1FFFH	Error code specific to each module, such as self-diagnostics errors
	Moderate error	2000H to 3BFFH	
	Major error	3C00H to 3FFFH	
Detected during communication between CPU modules		4000H to 4FFFH	Error in the CPU module
		7000H to 7FFFH	📖 MELSEC iQ-F FX5 User's Manual (Serial Communication) 📖 MELSEC iQ-F FX5 User's Manual (MODBUS Communication)
		C000H to CFBFH	📖 MELSEC iQ-F FX5 User's Manual (Ethernet Communication)
		CFC0H to CFFFH	Error in CC-Link IE Field Network Basic
		D000H to DFFFH	📖 MELSEC iQ-F FX5 User's Manual (CC-Link IE)

Detailed information

Upon detection of error through self-diagnostics function, the detailed information of the error cause is stored all together. The following detailed information is added to each error code (up to two types of information are stored for each error code. The types differ depending on error code.) Detailed information 1 to 2 of the latest error code(s) can be checked with special register (SD).

Detailed information	Item	Description
Detailed information 1	Error location information ^{*1}	Information on the location in a program
	Drive/file information	Information on drive names and file names
	Parameter information	The information for the parameter, such as parameter storage location and parameter type, is indicated.
	System configuration information	The information for the system configuration, such as I/O No is indicated.
	Frequency information	This section describes the information for frequency such as the write frequency into memory.
	Time information	The information for the time is indicated.
Detailed information 2	Drive/file information	Information on drive names and file names
	Annunciator information	Information about annunciators
	Parameter information	The information for the parameter, such as parameter storage location and parameter type, is indicated.
	System configuration information	The information for the system configuration, such as I/O No is indicated.

*1 The step No, which is displayed in the program position information, is the step No that is counted from the head of the file. It might be sometimes different from the step No of the program which is displayed in error jump of engineering tool.

Operation when an error occurs

There are two types of errors: continuation errors and stop errors.

Stop error

If a stop error occurs, the CPU module stops its operation and the operating state will be in STOP. Modules can communicate with the CPU module even after a stop error occurs in the CPU module.

Continuation error

If a continuation error occurs, the CPU module continues its operation. (The operating state will remain the same.)

How to clear errors

Continuation errors can be cleared. (🔍 Page 193 Error Clear)

List of error codes

Self-diagnostics error codes of the CPU module (1000H to 3FFFH)

The following table lists the error codes detected by the self-diagnostics function of the CPU module.

Error code	Error name	Error details and cause	Stop/continue	Action	Detailed information	Diagnostic timing
1080H	ROM write count error	• The number of writes to the data memory exceeded 20,000 times.	Continue	• Replace the CPU module.	Frequency information	At write
1090H	Battery error	• Low battery voltage was detected. An error was also detected in a battery latched (backed) device.	Continue	• Check the connection of the battery. • Replace the battery as soon as possible.	—	At END instruction execution
1100H	Memory card access error	• Writing failed because the write protect switch of the memory card is enabled (writing is prohibited).	Continue	• Disable the write protect switch of the memory card.	—	At write
1120H	SNTP time setting error	• Clock setting has failed when the system is powered on or the CPU module is reset.	Continue	• Check if the time settings are correctly set in parameter. • Check if the specified SNTP server is operating normally and there is no failure on the network accessing the SNTP server computer.	—	At power-on, at RESET
112EH	Connection establishment failed	• The connection was not established during the open process.	Continue	• Check the operation of the external device. • Use an external device to confirm whether the open process was executed. • Review the port No. of the module with Ethernet, the IP address/port No. of the external device, and the opening method. • If the external device has a firewall set, check whether access is permitted. • Check whether the Ethernet cable is disconnected.	—	At END instruction execution
1134H	TCP connection timeout	• A TCP ULP timeout error has occurred in the TCP/IP communication. (The external device does not send an ACK response.)	Continue	• Check the operation of the external device. • Review the TCP ULP timeout value for the module with Ethernet. • Since there may be congestion of packets on the line, send data after a certain period of time. • Check if the connection cable is disconnected.	—	Always

A

Error code	Error name	Error details and cause	Stop/continue	Action	Detailed information	Diagnostic timing
1200H	Module moderate error detected	<ul style="list-style-type: none"> Detected a notice of moderate error occurrence from intelligent function module. 	Continue/stop ^{*1}	<ul style="list-style-type: none"> Confirm detailed information (system configuration information) from module diagnosis of the engineering tool and remove the error of the abnormal module. 	System configuration information	At END instruction execution
1800H	Annunciator ON	<ul style="list-style-type: none"> An annunciator that was turned ON by the SET F instruction or OUT F instruction was detected. 	Continue	<ul style="list-style-type: none"> Check the program of that number (annunciator number). 	Error location information and annunciator information	At instruction execution
1810H	Operation error	<ul style="list-style-type: none"> The channel specified by instructions using communication functions or built-in I/O is already used by other instructions. 	Continue/stop ^{*1}	<ul style="list-style-type: none"> Verify that the channel specified by instructions using communication functions or built-in I/O is not used by other instructions. 	Error location information	At instruction execution
1811H	Operation error	<ul style="list-style-type: none"> The number of times that applied instructions are used in the program exceeded the specified limit. 	Continue/stop ^{*1}	<ul style="list-style-type: none"> Verify that the number of times that applied instructions are used in the program does not exceed the specified limit. 	Error location information	At instruction execution
1821H	Write during RUN error (axis 1)	<ul style="list-style-type: none"> Writing during RUN (change or deletion) is performed on an instruction being executed. 	Continue	<ul style="list-style-type: none"> Verify that the writing during RUN (change or deletion) is performed on an instruction being executed. E If the writing is executed during an ongoing RUN, after confirming that the pulse output is not occurring, turn OFF → ON the driving contact point to start the operation of the positioning instruction. 	Error location information and system configuration information	At END instruction execution
1822H	Write during RUN error (axis 2)	<ul style="list-style-type: none"> Writing during RUN (change or deletion) is performed on an instruction being executed. 	Continue	<ul style="list-style-type: none"> Verify that the writing during RUN (change or deletion) is performed on an instruction being executed. E If the writing is executed during an ongoing RUN, after confirming that the pulse output is not occurring, turn OFF → ON the driving contact point to start the operation of the positioning instruction. 	Error location information and system configuration information	At END instruction execution
1823H	Write during RUN error (axis 3)	<ul style="list-style-type: none"> Writing during RUN (change or deletion) is performed on an instruction being executed. 	Continue	<ul style="list-style-type: none"> Verify that the writing during RUN (change or deletion) is performed on an instruction being executed. E If the writing is executed during an ongoing RUN, after confirming that the pulse output is not occurring, turn OFF → ON the driving contact point to start the operation of the positioning instruction. 	Error location information and system configuration information	At END instruction execution
1824H	Write during RUN error (axis 4)	<ul style="list-style-type: none"> Writing during RUN (change or deletion) is performed on an instruction being executed. 	Continue	<ul style="list-style-type: none"> Verify that the writing during RUN (change or deletion) is performed on an instruction being executed. E If the writing is executed during an ongoing RUN, after confirming that the pulse output is not occurring, turn OFF → ON the driving contact point to start the operation of the positioning instruction. 	Error location information and system configuration information	At END instruction execution
1825H	Write during RUN error (axis 5)	<ul style="list-style-type: none"> Writing during RUN (change or deletion) is performed on an instruction being executed. 	Continue	<ul style="list-style-type: none"> Verify that the writing during RUN (change or deletion) is performed on an instruction being executed. E If the writing is executed during an ongoing RUN, after confirming that the pulse output is not occurring, turn OFF → ON the driving contact point to start the operation of the positioning instruction. 	Error location information and system configuration information	At END instruction execution

Error code	Error name	Error details and cause	Stop/continue	Action	Detailed information	Diagnostic timing
1826H	Write during RUN error (axis 6)	• Writing during RUN (change or deletion) is performed on an instruction being executed.	Continue	<ul style="list-style-type: none"> Verify that the writing during RUN (change or deletion) is performed on an instruction being executed. If the writing is executed during an ongoing RUN, after confirming that the pulse output is not occurring, turn OFF → ON the driving contact point to start the operation of the positioning instruction. 	Error location information and system configuration information	At END instruction execution
1827H	Write during RUN error (axis 7)	• Writing during RUN (change or deletion) is performed on an instruction being executed.	Continue	<ul style="list-style-type: none"> Verify that the writing during RUN (change or deletion) is performed on an instruction being executed. If the writing is executed during an ongoing RUN, after confirming that the pulse output is not occurring, turn OFF → ON the driving contact point to start the operation of the positioning instruction. 	Error location information and system configuration information	At END instruction execution
1828H	Write during RUN error (axis 8)	• Writing during RUN (change or deletion) is performed on an instruction being executed.	Continue	<ul style="list-style-type: none"> Verify that the writing during RUN (change or deletion) is performed on an instruction being executed. If the writing is executed during an ongoing RUN, after confirming that the pulse output is not occurring, turn OFF → ON the driving contact point to start the operation of the positioning instruction. 	Error location information and system configuration information	At END instruction execution
1829H	Write during RUN error (axis 9)	• Writing during RUN (change or deletion) is performed on an instruction being executed.	Continue	<ul style="list-style-type: none"> Verify that the writing during RUN (change or deletion) is performed on an instruction being executed. If the writing is executed during an ongoing RUN, after confirming that the pulse output is not occurring, turn OFF → ON the driving contact point to start the operation of the positioning instruction. 	Error location information and system configuration information	At END instruction execution
182AH	Write during RUN error (axis 10)	• Writing during RUN (change or deletion) is performed on an instruction being executed.	Continue	<ul style="list-style-type: none"> Verify that the writing during RUN (change or deletion) is performed on an instruction being executed. If the writing is executed during an ongoing RUN, after confirming that the pulse output is not occurring, turn OFF → ON the driving contact point to start the operation of the positioning instruction. 	Error location information and system configuration information	At END instruction execution
182BH	Write during RUN error (axis 11)	• Writing during RUN (change or deletion) is performed on an instruction being executed.	Continue	<ul style="list-style-type: none"> Verify that the writing during RUN (change or deletion) is performed on an instruction being executed. If the writing is executed during an ongoing RUN, after confirming that the pulse output is not occurring, turn OFF → ON the driving contact point to start the operation of the positioning instruction. 	Error location information and system configuration information	At END instruction execution
182CH	Write during RUN error (axis 12)	• Writing during RUN (change or deletion) is performed on an instruction being executed.	Continue	<ul style="list-style-type: none"> Verify that the writing during RUN (change or deletion) is performed on an instruction being executed. If the writing is executed during an ongoing RUN, after confirming that the pulse output is not occurring, turn OFF → ON the driving contact point to start the operation of the positioning instruction. 	Error location information and system configuration information	At END instruction execution
1900H	Constant scan time error	• The scan time exceeded the constant scan setting value.	Continue	• Check and correct the constant scan time setting. Recheck the setting time of the constant scan.	Time information	At END instruction execution

Error code	Error name	Error details and cause	Stop/continue	Action	Detailed information	Diagnostic timing
1910H	Update error	• The file for updating is not found.	Continue	• Check the update setting.	Drive/file information	At power-on, at RESET
1911H	Update error	• The module to be updated is not connected to a correct position.	Continue	• Check the update setting and the connection of the module to be updated.	Drive/file information	At power-on, at RESET
1912H	Update error	• Recovery of the project data saved in the SD memory card failed.	Continue	• Recovery of the project data failed, so initialize all data, and then write in the set of project data backed up by the customer.	Drive/file information	At power-on, at RESET
1920H	IP address setting error	• Values such as the IP address setting (SD8492 to SD8497) are outside the set range.	Continue	• Recheck the values such as the IP address setting (SD8492 to SD8497).	—	At END instruction execution
1921H	IP address writing/clear request simultaneous detection	• Write request and clear request (M8492 and SM8495) turned from OFF to ON simultaneously.	Continue	• Verify that write request and clear request (SM8492 and MS8495) do not turn from OFF to ON simultaneously.	—	At END instruction execution
1930H to 1932H	Online change error	• An error was detected when writing was executed during RUN.	Continue	• Set the CPU module to STOP and write a set of project data.	—	At END instruction execution
1FE0H	Module configuration error	• The number of I/O points specified in the I/O assignment setting of the parameters is different from that of the module connected.	Continue/stop ^{*1}	• Make sure that the parameters are consistent with the connections.	System configuration information	At power-on, at RESET
1FE1H	Module configuration error	• The module position specified in the I/O assignment setting of the parameters is different from that of the module connected.	Continue/stop ^{*1}	• Make sure that the parameters are consistent with the connections.	System configuration information	At power-on, at RESET
1FE2H	Module configuration error	• No parameters available for the module connected exist.	Continue/stop ^{*1}	• Make sure that the parameters are consistent with the connections.	System configuration information	At power-on, at RESET
1FE3H	Module configuration error	• The module specified in the I/O assignment setting of the parameters is not connected.	Continue/stop ^{*1}	• Make sure that the parameters are consistent with the connections.	System configuration information	At power-on, at RESET
1FE4H	Module configuration error	• Parameters for a standard input/output module are set to a high-speed pulse input/output module.	Continue/stop ^{*1}	• Make sure that the parameters are consistent with the connections.	System configuration information	At power-on, at RESET
1FE5H	Module configuration error	• The I/O numbers of the reserved module specified in the I/O assignment setting of the parameters overlap those of other modules.	Continue/stop ^{*1}	• Make sure that the parameters are consistent with the connections.	System configuration information	At power-on, at RESET
1FE6H	Module configuration error	• The I/O method of the input/output module is different.	Continue/stop ^{*1}	• Make sure that the parameters are consistent with the connections.	System configuration information	At power-on, at RESET
1FE7H	Module configuration error	• The type of the CPU module is different.	Continue/stop ^{*1}	• Make sure that the parameters are consistent with the connections.	System configuration information	At power-on, at RESET
1FE8H	Module configuration error	• The remote I/O points required by the system is insufficient.	Continue	• Set the number of I/O points again within the maximum number of points for the entire system. • The maximum number of points differs depending on the firmware version. Confirm the firmware version and update it if necessary.	System configuration information	At power-on, at RESET
2003H	Module configuration error	• The model of the module connected is different from that of the module set in the parameters.	Stop	• Make sure the model of the module to be set is consistent with the parameters of the module connected.	System configuration information	At power-on, at RESET

Error code	Error name	Error details and cause	Stop/continue	Action	Detailed information	Diagnostic timing
2008H	Module configuration error	<ul style="list-style-type: none"> The total number of I/O points (excluding remote I/O) exceeded the maximum points. 	Continue	<ul style="list-style-type: none"> Do not use more than the maximum I/O points in programs. If writing failed, restart or reset the CPU module and then perform write during STOP status. 	System configuration information	At power-on, at RESET
2042H	CPU module configuration error	<p>■FX5UJ CPU module</p> <ul style="list-style-type: none"> The number of input, output, input/output, and intelligent function modules connected is equal to or greater than 9. The number of simple motion modules connected is equal to or greater than 2. The number of communication adapters connected is equal to or greater than 3. The number of analog adapters connected is equal to or greater than 3. The number of extension power supply modules connected is equal to or greater than 2. The number of expansion boards connected is equal to or greater than 2. The number of intelligent function modules connected exceeds the limit of available connection. With a communication board, the number of communication adapters connected is equal to or greater than 2. <p>■FX5U/FX5UC CPU module</p> <ul style="list-style-type: none"> The number of input, output, input/output, and intelligent function modules connected is equal to or greater than 17. The number of communication adapters connected is equal to or greater than 3. The number of analog adapters connected is equal to or greater than 5. The number of extension power supply modules connected is equal to or greater than 3. The number of expansion boards connected is equal to or greater than 2. The number of intelligent function modules connected exceeds the limit of available connection. 	Stop	<p>■FX5UJ CPU module</p> <ul style="list-style-type: none"> Use up to 8 input, output, input/output, and intelligent function modules. Use up to 1 simple motion modules. Use up to 2 communication adapters. Use up to 2 analog adapters. Use up to 1 extension power supply module. Use up to 1 expansion board. Connect each intelligent function modules within the connectable limit. When a communication board and a communication adapter are combined, the allowable number of communication adapters is 1 or less. <p>■FX5U/FX5UC CPU module</p> <ul style="list-style-type: none"> Use up to 16 input, output, input/output, and intelligent function modules. Use up to 2 communication adapters. Use up to 4 analog adapters. Use up to 2 extension power supply modules. Use up to 1 expansion board. Connect each intelligent function modules within the connectable limit. 	System configuration information	At power-on, at RESET
20E0H	Invalid module detection	<ul style="list-style-type: none"> An unsupported module was detected. 	Stop	<ul style="list-style-type: none"> Verify that the firmware version of the CPU module is compatible with the module where the error was detected. If the firmware version of the CPU module is correct, there may be a malfunction in the connected module. Replace the connected module. 	System configuration information	At power-on, at RESET
2120H	Memory card error	<ul style="list-style-type: none"> An SD memory card error was detected. The SD memory card may have been removed without the SD memory card disabled. 	Continue/stop ^{*1*3}	<ul style="list-style-type: none"> Check the connection of the SD memory card. If the problem persists, there may be a malfunction in the SD memory card or CPU module. 	Drive/file information	Always

Error code	Error name	Error details and cause	Stop/continue	Action	Detailed information	Diagnostic timing
2121H	Memory card error	<ul style="list-style-type: none"> An SD memory card error was detected. The SD memory card may not be correctly formatted. 	Continue/stop ^{*1*3}	<ul style="list-style-type: none"> Format the SD memory card. If the problem persists, there may be a malfunction in the SD memory card or CPU module. 	Drive/file information	Always
2160H	IP address duplication error	<ul style="list-style-type: none"> The IP address is duplicated within the system. 	Continue	<ul style="list-style-type: none"> Review the setting so that the IP address is not duplicated within the system. 	—	Always
2180H	Invalid file detection	<ul style="list-style-type: none"> An error was found in the data of the file. 	Stop	<ul style="list-style-type: none"> Recreate the file. 	Drive/file information	At power-on, at RESET, at STOP → RUN state
21A0H	File specification error	<ul style="list-style-type: none"> The booted CPU module and the booting CPU module are not of the same model. The file specified in the parameters does not exist. 	Stop	<ul style="list-style-type: none"> Boot the CPU module from a CPU module of the same model. Rewrite the project. If the same error appears, the hardware of the CPU module may be malfunctioning. Initialize the memory, and if the memory still cannot be recovered, consult your local Mitsubishi Electric representative. 	Drive/file information Parameter information	At power-on, at RESET, at STOP → RUN state
21A1H	File specification error	<ul style="list-style-type: none"> The file specified in parameter cannot be created. 	Stop	<ul style="list-style-type: none"> Check the detailed information (parameter information) of the error by executing module diagnostics using the engineering tool, and correct the name and size of the file corresponding to the displayed parameter number. Check the detailed information (drive/file information) of the error by executing module diagnostics using the engineering tool, and take the following actions: <ol style="list-style-type: none"> Format the corresponding drive. Delete unnecessary files on the corresponding drive to increase free space. Unlock the corresponding drive if it is locked. 	Drive/file information	At power-on, at RESET
2200H	Parameter error	<ul style="list-style-type: none"> The parameter file is not found. 	Stop	<ul style="list-style-type: none"> Rewrite the project. 	Parameter information	At power-on, at RESET
2220H	Parameter error	<ul style="list-style-type: none"> The contents of the parameters are corrupted. 	Stop	<ul style="list-style-type: none"> Rewrite the project. 	Parameter information	At power-on, at RESET
2221H	Parameter error	<ul style="list-style-type: none"> The parameter set value is out of range. 	Stop	<ul style="list-style-type: none"> Modify the parameter set value and rewrite the project. When an intelligent function module is connected to a CPU module, check that the firmware version of the CPU module is compatible with the intelligent function module, and if not compatible, execute the firmware update. 	Parameter information	At power-on, at RESET
2222H	Parameter error	<ul style="list-style-type: none"> The parameter set value is out of range. A setting has been made to use a function not supported by the target module. 	Stop	<ul style="list-style-type: none"> Modify the parameter set value and rewrite the project. When an intelligent function module is connected to a CPU module, check that the firmware version of the CPU module is compatible with the intelligent function module, and if not compatible, execute the firmware update. 	Parameter information	At power-on, at RESET
2226H	Parameter error	<ul style="list-style-type: none"> The SFC settings in the CPU parameter is incorrect. (Block 0 was set to start automatically, however, block 0 does not exist.) 	Stop	<ul style="list-style-type: none"> Check the detailed information (parameter information) of the error by executing module diagnostics using the engineering tool and correct the parameter settings corresponding to the displayed number. 	Parameter information	At power-on, at RESET, at STOP → RUN state, at SFC program execution

Error code	Error name	Error details and cause	Stop/continue	Action	Detailed information	Diagnostic timing
2227H	Parameter error	<ul style="list-style-type: none"> The execution type of the SFC program set in the CPU parameter program settings is other than the scan execution type. 	Stop	<ul style="list-style-type: none"> Check the detailed information (parameter information) of the error by executing module diagnostics using the engineering tool and correct the parameter settings corresponding to the displayed number. 	Parameter information	At power-on, at RESET
2241H	Parameter error (module)	<ul style="list-style-type: none"> The module parameter settings and the target module are different. 	Stop	<ul style="list-style-type: none"> Modify the module parameter set value and rewrite the project. 	Parameter information	At power-on, at RESET
2260H	Network parameter error	<ul style="list-style-type: none"> Network no. is duplicated. 	Stop	<ul style="list-style-type: none"> Check the detailed information (parameter information) in the module diagnosis of the engineering tool, and review the parameter setting corresponding to the numerical value (parameter No.). If the same error is displayed again, there may be a hardware error in the data memory of the CPU module or the intelligent function module. Please contact your local Mitsubishi Electric representative. 	Parameter information	At power-on, at RESET
2280H	Parameter error (refresh)	<ul style="list-style-type: none"> The refresh setting is set exceeding the device capacity. 	Stop	<ul style="list-style-type: none"> Check the detailed information (parameter information) of the error by executing module diagnosis using the engineering tool, correct the parameter setting corresponding to the displayed value (parameter No.) and set the refresh range within the device setting range. Rewrite the refresh settings (number of points) of the CPU parameter. 	Parameter information	At power-on, at RESET, at STOP → RUN state, at END instruction execution, at instruction execution, at module access
2281H	Parameter error (refresh)	<ul style="list-style-type: none"> A device that cannot be used as a refresh device is specified. 	Stop	<ul style="list-style-type: none"> Check the detailed information (parameter information) of the error by executing module diagnostics using the engineering tool, and correct the parameter setting corresponding to the displayed number. 	Parameter information	At power-on, at RESET, at STOP → RUN state
2282H	Parameter error (refresh)	<ul style="list-style-type: none"> The number of specified refresh points is invalid. 	Stop	<ul style="list-style-type: none"> Check the detailed information (parameter information) of the error by executing module diagnostics using the engineering tool, and correct the parameter setting corresponding to the displayed number. 	Parameter information	At power-on, at RESET, at STOP → RUN state
2283H	Parameter error (refresh)	<ul style="list-style-type: none"> The total number of refresh points exceeded the maximum limit. 	Stop	<ul style="list-style-type: none"> Check the detailed information (parameter information) of the error by executing module diagnostics using the engineering tool, and correct the parameter setting corresponding to the displayed number. 	Parameter information	At power-on, at RESET, at STOP → RUN state
2300H	Security key authentication error	<ul style="list-style-type: none"> The security key locking the program does not match the security key written in the CPU module. 	Stop	<ul style="list-style-type: none"> Write the correct security key to the CPU module. 	Drive/file information	At power-on, at RESET, at STOP → RUN state
2301H	Security key authentication error	<ul style="list-style-type: none"> The program is locked by the security key, but the security key is not written in the CPU module. 	Stop	<ul style="list-style-type: none"> Write the security key to the CPU module. 	Drive/file information	At power-on, at RESET, at STOP → RUN state
2302H	Security key authentication error	<ul style="list-style-type: none"> The security key written in the CPU module is corrupted. 	Stop	<ul style="list-style-type: none"> Rewrite the security key to the CPU module. 	—	At power-on, at RESET, at STOP → RUN state
2320H	Remote password setting error	<ul style="list-style-type: none"> A module supporting remote passwords is not connected to the module number specified in the remote password parameter. 	Stop	<ul style="list-style-type: none"> Recheck the remote password parameter setting or module configuration. 	System configuration information	At power-on, at RESET

Error code	Error name	Error details and cause	Stop/continue	Action	Detailed information	Diagnostic timing
2400H	Module verification error	<ul style="list-style-type: none"> The power of a module connected is OFF or a connection error has been detected. 	Stop/continue ^{*2}	<ul style="list-style-type: none"> Verify that the connected module is powered on. Verify that extension cables are correctly connected. Implement anti-noise measures. If there is no problem, there may be a malfunction in the connected module. Replace the connected module. 	System configuration information	Always
2401H	Module verification error	<ul style="list-style-type: none"> A module was connected during operation. 	Stop/continue ^{*2}	<ul style="list-style-type: none"> Avoid connecting a module during operation. 	System configuration information	Always
2440H	Module major error	<ul style="list-style-type: none"> The communication procedure with a module failed during initial processing. 	Stop	<ul style="list-style-type: none"> Verify that extension cables are correctly connected. Verify that the firmware version of the CPU module is compatible with the module where the error was detected. If the version of the CPU module is correct, there may be a malfunction in the connected module. Replace the connected module. 	System configuration information	At power-on, at RESET
2441H	Module major error	<ul style="list-style-type: none"> The communication procedure with a module failed when an instruction was executed. 	Continue/stop ^{*1}	<ul style="list-style-type: none"> Review the program and check the contents of the operands used in the applied instructions. Verify that the specified buffer memory exists in the counterpart equipment. Verify that extension cables are correctly connected. 	Error location information and system configuration information	At instruction execution
2442H	Module major error	<ul style="list-style-type: none"> An error has been detected in the I/O module or intelligent function module during the END processing. 	Continue/stop ^{*1}	<ul style="list-style-type: none"> Refer to the manuals for the modules, and check the restrictions on the number of connected modules and the number of input/output points. There may be a hardware error in the faulty module. Consult your local Mitsubishi Electric representative. 	System configuration information	At module access
2450H	Module major error detected	<ul style="list-style-type: none"> Detected a notice of major error occurrence from intelligent function module. 	Stop/continue ^{*2}	<ul style="list-style-type: none"> Take measures against noise. Verify that extension cables are correctly connected. Confirm detailed information (system configuration information) in module diagnosis of engineering tool, and please check module corresponding to the numerical value (module No.). In addition, please confirm the details with reference to the manual of target module. After resetting the CPU unit, please execute RUN. If the same error is displayed again, there might be hardware failure of the module which became abnormal. Please contact the nearest Mitsubishi Electric system service Co., Ltd. or our branch office, agency. 	System configuration information	At END instruction execution
2463H	Intelligent module major error	<ul style="list-style-type: none"> An error has been detected in intelligent function module. 	Stop	<ul style="list-style-type: none"> Reset the CPU module, and run it again. If the same error code is displayed again, the possible cause is a hardware failure of the CPU module or intelligent function module where the error has been detected. Consult with your local Mitsubishi Electric representative. 	System configuration information	At power-on, at RESET
2500H	WDT error	<ul style="list-style-type: none"> The initial scan time exceeded the set value of execution monitor time. The execution time of a fixed-cycle interrupt program exceeds the interrupt execution interval. 	Stop	<ul style="list-style-type: none"> Recheck the set value of execution monitor time or program. 	Time information	Always

Error code	Error name	Error details and cause	Stop/continue	Action	Detailed information	Diagnostic timing
2501H	WDT error	<ul style="list-style-type: none"> The scan time of the second and subsequent scans exceeded the set value of execution monitor time. The execution time of a fixed-cycle interrupt program exceeds the interrupt execution interval. 	Stop	<ul style="list-style-type: none"> Recheck the set value of execution monitor time or program. 	Time information	Always
2522H	Invalid interrupt	<ul style="list-style-type: none"> An interrupt request was detected from a module that does not have an interrupt pointer specified in the parameters. 	Continue	<ul style="list-style-type: none"> Correctly set the interrupt pointer for module interrupt. 	System configuration information	At interrupt occurrence
2800H	Module specification error	<ul style="list-style-type: none"> The specified module number is out of range. 	Continue/stop ^{*1}	<ul style="list-style-type: none"> Check the detailed information (error location information) of the error by executing module diagnostics using the engineering tool, display the error program (step) by the error jump, and correct the program. 	Error location information	At instruction execution
2801H	Module specification error	<ul style="list-style-type: none"> Verify that the module with the specified module number exists. 	Continue/stop ^{*1}	<ul style="list-style-type: none"> Specify the correct module number. 	Error location information and system configuration information	At instruction execution
2802H	Module specification error	<ul style="list-style-type: none"> The module number of the module that does not support the instruction was specified. The dedicated instruction specified in the program cannot be executed in the specified module or mode. 	Continue/stop ^{*1}	<ul style="list-style-type: none"> Check the detailed information (error location information) of the error by executing module diagnostics using the engineering tool, display the error program (step) by the error jump, and correct the program. Check the execution conditions (including support status and execution mode) of the dedicated instruction, referring to the manual for the target module. 	Error location information	At instruction execution
2820H	Device specification error	<ul style="list-style-type: none"> A device used as an instruction operand is outside the allowable device range. 	Continue	<ul style="list-style-type: none"> Check the device range and modify the program. 	Error location information	At power-on, at RESET, at instruction execution
2821H	Device specification error	<ul style="list-style-type: none"> There are incorrect devices used as an instruction operand. 	Continue	<ul style="list-style-type: none"> Check the range of devices used by each operand and modify the program. 	Error location information	At instruction execution
2822H	Device specification error	<ul style="list-style-type: none"> A device or modification that cannot be used as an instruction operand is used. The step relay (S) is used as the operand of an instruction other than the SFC control instruction when the SFC program setting of the CPU parameter is set to "Use". 	Stop	<ul style="list-style-type: none"> Check the usage of the instruction and modify the program. Change the step relay (S) used for the instruction to another device. (When the SFC program setting is set to "Use", the step relay (S) cannot be used for commands other than SFC control instructions.) 	Error location information	At power-on, at RESET
2823H	Device specification error	<ul style="list-style-type: none"> Verify that the specified module has buffer memory. Check the buffer memory range of the specified module. Verify that the size specified from the specified buffer memory number is within the buffer memory range. 	Continue	<ul style="list-style-type: none"> Review the program or check the contents of the operands used in applied instructions. Verify that the specified buffer memory exists in the counterpart equipment. 	Error location information	At instruction execution
2840H	File name specification error	<ul style="list-style-type: none"> The program file specified does not exist. 	Stop	<ul style="list-style-type: none"> Rewrite the project. 	Error location information	At power-on, at RESET
3000H	Boot function execution error	<ul style="list-style-type: none"> An error was found in the boot file. 	Stop	<ul style="list-style-type: none"> Replace the boot file in the SD memory card with the correct file and turn the PLC power ON again. 	Drive/file information	At power-on, at RESET

Error code	Error name	Error details and cause	Stop/continue	Action	Detailed information	Diagnostic timing
3001H	Boot function execution error	<ul style="list-style-type: none"> Formatting failed during booting. 	Stop	<ul style="list-style-type: none"> Reset the CPU module, and then execute the boot function again. If the same error appears, the hardware of the CPU module may be malfunctioning. Consult your local Mitsubishi Electric representative. 	Drive/file information	At power-on, at RESET
3003H	Boot function execution error	<ul style="list-style-type: none"> A mismatch between the file password of the boot source file and that of the boot destination file was detected during booting. 	Stop	<ul style="list-style-type: none"> Check the file password of the boot source file. 	Drive/file information	At power-on, at RESET
3004H	Boot function execution error	<ul style="list-style-type: none"> The capacity of the boot destination data memory becomes insufficient due to booting. 	Stop	<ul style="list-style-type: none"> Allow sufficient capacity on the boot destination or recheck the file size of the boot source. 	Drive/file information	At power-on, at RESET
3005H	Boot function execution error	<ul style="list-style-type: none"> A mismatch between the security information of the boot source file and that of the boot destination file was detected during booting. 	Stop	<ul style="list-style-type: none"> Check the security information of the boot source file. 	Drive/file information	At power-on, at RESET
3010H	Data restoration function execution error	<ul style="list-style-type: none"> The CPU module at the restoration destination does not match the backup source CPU module model. 	Stop	<ul style="list-style-type: none"> Execute CPU module restoration with the same CPU module model as the backup source CPU module. Turn off b0 of SD955 (Automatic restoration execution) to disable the automatic data restoration function. 	CPU module data backup/restoration folder information	At power-on, at RESET
3011H	Data restoration function execution error	<ul style="list-style-type: none"> Reading of backup data from an SD memory card completed with an error. 	Stop	<ul style="list-style-type: none"> Replace the SD memory card, and execute the function again. The backup data may have been corrupted. Execute the data restoration function using another backup data. Turn off b0 of SD955 (Automatic restoration execution) to disable the automatic data restoration function. 	CPU module data backup/restoration folder information	At power-on, at RESET
3012H	Data restoration function execution error	<ul style="list-style-type: none"> Writing of backup data to the CPU built-in memory completed with an error. 	Stop	<ul style="list-style-type: none"> Possible cause is hardware failure of the restoration target CPU module. Execute the data restoration function to another CPU module. 	CPU module data backup/restoration folder information	At power-on, at RESET
3013H	Data restoration function execution error	<ul style="list-style-type: none"> The system file does not exist in the backup data to be restored. File(s) in the system file information does not exist in the folder of the backed up data. The CPU module at the restoration destination does not match the backup source CPU module model. 	Stop	<ul style="list-style-type: none"> The backup data may have been corrupted. Execute the data restoration function using another backup data. Turn off b0 of SD955 (Automatic restoration execution) to disable the automatic data restoration function. Execute CPU module restoration with the same CPU module model as the backup source CPU module. 	CPU module data backup/restoration folder information	At power-on, at RESET
3014H	Data restoration function execution error	<ul style="list-style-type: none"> Data was restored to the CPU module where the same data with a file password has already been stored. 	Stop	<ul style="list-style-type: none"> Delete file passwords, and execute the CPU module data backup/restoration function. Turn off b0 of SD955 (Automatic restoration execution) to disable the automatic data restoration function. 	CPU module data backup/restoration folder information	At power-on, at RESET
3015H	Data restoration function execution error	<ul style="list-style-type: none"> A folder with a value that matches the restoration target date folder setting value or number folder setting value does not exist in the SD memory card. The restoration target data setting value is out of range. The restoration target date folder setting value or number folder setting value is out of range. 	Stop	<ul style="list-style-type: none"> Check and correct the restoration target date folder setting value or number folder setting value, and execute the function again. Check and correct the restoration target data setting value, and execute the function again. Turn off b0 of SD955 (Automatic restoration execution) to disable the automatic data restoration function. 	CPU module data backup/restoration folder information	At power-on, at RESET

Error code	Error name	Error details and cause	Stop/continue	Action	Detailed information	Diagnostic timing
3016H	Data restoration function execution error	<ul style="list-style-type: none"> The automatic data restoration function was executed with the CPU module where an SD memory card was not inserted. 	Stop	<ul style="list-style-type: none"> Insert or re-insert an SD memory card, and execute the function again. Turn off b0 of SD955 (Automatic restoration execution) to disable the automatic data restoration function. 	CPU module data backup/restoration folder information	At power-on, at RESET
3017H	Data restoration function execution error	<ul style="list-style-type: none"> The automatic data restoration function was executed exceeding the maximum memory capacity of the CPU module. The automatic data restoration function was executed exceeding the maximum number of files that can be stored in the CPU module. 	Stop	<ul style="list-style-type: none"> Execute the function so that the maximum memory capacity will not be exceeded. Execute the function so that the maximum number of storable files will not be exceeded. Turn off b0 of SD955 (Automatic restoration execution) to disable the automatic data restoration function. 	CPU module data backup/restoration folder information	At power-on, at RESET
3018H	Data restoration function execution error	<ul style="list-style-type: none"> The status (such as programs, parameters, and file structure) of the CPU module differs from that of when the data backup function was executed. 	Stop	<ul style="list-style-type: none"> Match the CPU module status to the one at the time of backup, and execute the function again. Set all data as the restoration target data, and execute the data restoration function. Turn off b0 of SD955 (Automatic restoration execution) to disable the automatic data restoration function. 	CPU module data backup/restoration folder information	At power-on, at RESET
301FH	Data restoration function execution error	<ul style="list-style-type: none"> The backup data is broken. 	Stop	<ul style="list-style-type: none"> Back up the data again, and then execute CPU module auto exchange. 	CPU module data backup/restoration folder information	At power-on, at RESET
3040H	Update error	<ul style="list-style-type: none"> The update file which is used for the firmware update is not compatible with the models and serial numbers of the target CPU module and intelligent function module. 	Stop	<ul style="list-style-type: none"> Check the models, serial numbers, and versions of the target CPU module and intelligent function module. Use the update file compatible with them and update the firmware. 	Drive/file information	At power-on, at RESET
3041H	Update error	<ul style="list-style-type: none"> An error was found in the update file. 	Stop	<ul style="list-style-type: none"> Replace the update file in the SD memory card with the correct file, and execute the update once again. 	Drive/file information	At power-on, at RESET
3042H	Update error	<ul style="list-style-type: none"> An error is detected in the update of the extension module. 	Stop	<ul style="list-style-type: none"> Replace the update file in the SD memory card with the correct file, and execute the update once again. 	System configuration information	At power-on, at RESET
3043H	Update error	<ul style="list-style-type: none"> Saving the device comment file into the SD memory card failed. 	Stop	<ul style="list-style-type: none"> Disable the write protect of the SD memory card. 	Drive/file information	At power-on, at RESET
3044H	Update error	<ul style="list-style-type: none"> Firmware update is prohibited. 	Stop	<ul style="list-style-type: none"> Review the firmware update prohibit settings. 	—	At power-on, at RESET
3045H	Update error	<ul style="list-style-type: none"> Recovery of the project data saved in the SD memory card failed. 	Stop	<ul style="list-style-type: none"> Confirm that the SD memory card used with the firmware update is inserted, and then turn the power OFF and ON again. If the data cannot be recovered, the data stored on the SD memory card may be damaged. After initializing the CPU built-in memory, write in the set of project data backed up by the customer. 	Drive/file information	At power-on, at RESET
3046H	Update error	<ul style="list-style-type: none"> The update file (HVF extension) is not found. An error was found in the update file (HVF extension). 	Stop	<ul style="list-style-type: none"> Replace the update file in the SD memory card with the correct file (HVF extension), and execute the update once again. 	Drive/file information	At power-on, at RESET
3048H	Online change error	<ul style="list-style-type: none"> An error was detected when writing was executed during RUN. 	Stop	<ul style="list-style-type: none"> Set the CPU module to STOP and write a set of project data. 	—	At END instruction execution
3049H	Online change error	<ul style="list-style-type: none"> An error was detected when writing was executed during RUN. 	Stop	<ul style="list-style-type: none"> Set the CPU module to STOP and write a set of project data. 	—	At END instruction execution

Error code	Error name	Error details and cause	Stop/continue	Action	Detailed information	Diagnostic timing
304AH	Online change error	<ul style="list-style-type: none"> An error was detected when writing was executed during RUN. 	Stop	<ul style="list-style-type: none"> Set the CPU module to STOP and write a set of project data. 	—	At END instruction execution
304BH	Online change error	<ul style="list-style-type: none"> An error was detected when writing was executed during RUN. The power was restarted in a during online change failure. 	Stop	<ul style="list-style-type: none"> Set the CPU module to STOP and write a set of project data. 	—	At END instruction execution
3050H	System bus error	<ul style="list-style-type: none"> Communication with the module failed due to power discontinuity or the like. 	Stop	<ul style="list-style-type: none"> Verify that the connected module is powered on. Verify that extension cables are correctly connected. Verify that the firmware version of the CPU module is compatible with the module where the error was detected. Implement anti-noise measures. If there is no problem, there may be a malfunction in the connected module or in the extension cables. 	System configuration information	At power-on, at RESET
3052H	System bus error	<ul style="list-style-type: none"> The initial setting of the high-speed pulse input/output module caused an error. 	Stop	<ul style="list-style-type: none"> Verify that extension cables are correctly connected. Verify that the firmware version of the CPU module is compatible with the module where the error was detected. Implement anti-noise measures. If there is no problem, there may be a malfunction in the connected module or in the extension cables. 	System configuration information	At power-on, at RESET
3054H	System bus error	<ul style="list-style-type: none"> All module reset is executed. The positioning with the high-speed pulse input/output module caused an abnormal stop. 	Stop	<ul style="list-style-type: none"> Review the program and check the contents of the operands used in the applied instructions. Verify that the connected module is powered on. Verify that extension cables are correctly connected. Verify that the firmware version of the CPU module is compatible with the module where the error was detected. Implement anti-noise measures. If there is no problem, there may be a malfunction in the connected module or in the extension cables. 	System configuration information	At END instruction execution, at instruction execution
3055H	System bus error	<ul style="list-style-type: none"> All module reset is executed. The positioning with the high-speed pulse input/output module caused an abnormal stop. 	Stop	<ul style="list-style-type: none"> Review the program and check the contents of the operands used in the applied instructions. Verify that the connected module is powered on. Verify that extension cables are correctly connected. Verify that the firmware version of the CPU module is compatible with the module where the error was detected. Implement anti-noise measures. If there is no problem, there may be a malfunction in the connected module or in the extension cables. 	Error location information	At END instruction execution, at instruction execution

Error code	Error name	Error details and cause	Stop/continue	Action	Detailed information	Diagnostic timing
3056H	System bus error	<ul style="list-style-type: none"> A timeout occurred during communication with a connected module when an instruction was executed. 	Continue	<ul style="list-style-type: none"> Verify that extension cables are correctly connected. Verify that the firmware version of the CPU module is compatible with the module where the error was detected. Implement anti-noise measures. If there is no problem, there may be a malfunction in the connected module or in the extension cables. When an error occurs alongside positioning function, positioning may not stop at the specified position. After removing the cause of the system bus error, perform zero return and clear error. 	Error location information and system configuration information	At instruction execution
3057H	System bus error	<ul style="list-style-type: none"> A timeout occurred during communication with a connected module during system processing. 	Continue	<ul style="list-style-type: none"> Verify that extension cables are correctly connected. Verify that the firmware version of the CPU module is compatible with the module where the error was detected. Implement anti-noise measures. If there is no problem, there may be a malfunction in the connected module or in the extension cables. When an error occurs alongside positioning function, positioning may not stop at the specified position. After removing the cause of the system bus error, perform zero return and clear error. 	System configuration information	At END instruction execution, at interrupt occurrence, at module access
3060H	System bus error	<ul style="list-style-type: none"> A signal error was detected with a connected module when an instruction was executed. 	Continue	<ul style="list-style-type: none"> Verify that extension cables are correctly connected. Verify that the firmware version of the CPU module is compatible with the module where the error was detected. Implement anti-noise measures. If there is no problem, there may be a malfunction in the connected module or in the extension cables. When an error occurs alongside positioning function, positioning may not stop at the specified position. After removing the cause of the system bus error, perform zero return and clear error. 	Error location information	At instruction execution
3061H	System bus error	<ul style="list-style-type: none"> A signal error was detected during system processing. 	Continue	<ul style="list-style-type: none"> Verify that extension cables are correctly connected. Verify that the firmware version of the CPU module is compatible with the module where the error was detected. Implement anti-noise measures. If there is no problem, there may be a malfunction in the connected module or in the extension cables. When an error occurs alongside positioning function, positioning may not stop at the specified position. After removing the cause of the system bus error, perform zero return and clear error. 	System configuration information	At instruction execution



Error code	Error name	Error details and cause	Stop/continue	Action	Detailed information	Diagnostic timing
3100H	Program error	<ul style="list-style-type: none"> The program includes any instruction that cannot be used or decoded in the CPU module. Unicode strings are used as the input/output arguments of the FB, FUN, and FBD parts. Unicode strings are used in ST language. 	Stop	<ul style="list-style-type: none"> Check the detailed information (error location information) of the error by executing module diagnostics using the engineering tool, display the error program (step) by clicking the [Error Jump] button, and check the program. Implement anti-noise measures. Re-write the program, and run the program after resetting the CPU module. If the same error appears, the hardware of the CPU module may be malfunctioning. Please consult your local Mitsubishi representative. 	Error location information	At power-on, at RESET, at STOP → RUN state
3101H	Program error	<ul style="list-style-type: none"> The program contains a dedicated SFC program instruction even though it is not an SFC program. 	Stop	<ul style="list-style-type: none"> Check the detailed information (error location information) of the error by executing module diagnostics using the engineering tool, display the error program (step) by clicking the [Error Jump] button, and correct the program. Take measures to reduce noise. Write the sequence program(s) and FB program(s) to the CPU module again. Then, reset the CPU module and run it again. If the same error code is displayed again, the possible cause is a hardware failure of the CPU module. Please contact your nearest Mitsubishi Electric System Service Co., Ltd., or our branch or distributor. 	Error location information	At power-on, at RESET, at STOP → RUN state
3120H	Program error	<ul style="list-style-type: none"> The CPU module does not support the dedicated instruction executed. The dedicated instructions specified in the program cannot be executed with the specified module. 	Stop	<ul style="list-style-type: none"> Check the detailed information (error location information) of the error by executing module diagnostics using the engineering tool, display the error program (step) by the error jump, and correct the program. 	Error location information	At power-on, at RESET, at STOP → RUN state, at instruction execution
3121H	Program error	<ul style="list-style-type: none"> The number of devices used in the dedicated instruction specified in the program is incorrect. 	Stop	<ul style="list-style-type: none"> Check the detailed information (error location information) of the error by executing module diagnostics using the engineering tool, display the error program (step) by the error jump, and correct the program. 	Error location information	At instruction execution
3142H	Program structure error	<ul style="list-style-type: none"> The temporary area was used incorrectly. 	Stop	<ul style="list-style-type: none"> Check the detailed information (error location information) of the error by executing module diagnostics using the engineering tool, display the error program (step) by clicking the [Error Jump] button, and check the program. The step number displayed in the error location information is counted from the top of the file. (It may be different from the step number in the program displayed by the jump function.) 	Error location information	At instruction execution
3160H to 3163H	SFC program block, step error	<ul style="list-style-type: none"> The SFC program configuration is incorrect. 	Stop	<ul style="list-style-type: none"> Take measures to reduce noise. Write the SFC program to the CPU module again. Then, reset the CPU module and run it again. If the same error code is displayed again, the possible cause is a hardware failure of the CPU module. Please contact your nearest Mitsubishi Electric System Service Co., Ltd., or our branch or distributor. 	Error location information	At power-on, at RESET, at STOP → RUN state, at SFC program execution

Error code	Error name	Error details and cause	Stop/continue	Action	Detailed information	Diagnostic timing
3170H	SFC program block, step error	<ul style="list-style-type: none"> The number of steps in the SFC program exceeds the total number of step relays (S). 	Stop	<ul style="list-style-type: none"> Modify the program so that the number of steps in the SFC program does not exceed the total number of step relays. 	Error location information	At power-on, at RESET, at STOP → RUN state, at SFC program execution
3171H	SFC program block, step error	<ul style="list-style-type: none"> The total number of SFC program blocks (max. step No. + 1) exceeds the total number of step relays (S). 	Stop	<ul style="list-style-type: none"> Correct the program so that the total number of SFC program blocks (max. step No. + 1) does not exceed the total number of step relays (S). 	Error location information	At power-on, at RESET, at STOP → RUN state, at SFC program execution
3180H	SFC Program configuration error	<ul style="list-style-type: none"> The SFC program configuration is incorrect. 	Stop	<ul style="list-style-type: none"> Take measures to reduce noise. Write the SFC program to the CPU module again. Then, reset the CPU module and run it again. If the same error code is displayed again, the possible cause is a hardware failure of the CPU module. Please contact your nearest Mitsubishi Electric System Service Co., Ltd., or our branch or distributor. 	Error location information	At power-on, at RESET, at STOP → RUN state, at SFC program execution
3190H, 3191H	SFC Program configuration error	<ul style="list-style-type: none"> The SFC program configuration is incorrect. 	Stop	<ul style="list-style-type: none"> Take measures to reduce noise. Write the SFC program to the CPU module again. Then, reset the CPU module and run it again. If the same error code is displayed again, the possible cause is a hardware failure of the CPU module. Please contact your nearest Mitsubishi Electric System Service Co., Ltd., or our branch or distributor. 	Error location information	At SFC program execution
3192H	SFC Program configuration error	<ul style="list-style-type: none"> A self step number was specified for the specification destination step number for the jump transition. 	Stop	<ul style="list-style-type: none"> Check the detailed information (error location information) of the error by executing module diagnostics using the engineering tool, display the error program (step) by clicking the [Error Jump] button, and correct the program. Take measures to reduce noise. Write the SFC program to the CPU module again. Then, reset the CPU module and run it again. If the same error code is displayed again, the possible cause is a hardware failure of the CPU module. Please contact your nearest Mitsubishi Electric System Service Co., Ltd., or our branch or distributor. 	Error location information	At SFC program execution
3193H	SFC Program configuration error	<ul style="list-style-type: none"> A self step number was specified for the specification destination step number for the reset step. 	Stop	<ul style="list-style-type: none"> Check the detailed information (error location information) of the error by executing module diagnostics using the engineering tool, display the error program (step) by clicking the [Error Jump] button, and correct the program. Take measures to reduce noise. Write the SFC program to the CPU module again. Then, reset the CPU module and run it again. If the same error code is displayed again, the possible cause is a hardware failure of the CPU module. Please contact your nearest Mitsubishi Electric System Service Co., Ltd., or our branch or distributor. 	Error location information	At SFC program execution

Error code	Error name	Error details and cause	Stop/continue	Action	Detailed information	Diagnostic timing
31A0H	SFC program block, step specification error	<ul style="list-style-type: none"> An attempt was made to start an SFC program block that was already running. 	Stop	<ul style="list-style-type: none"> Check the detailed information (error location information) of the error by executing module diagnostics using the engineering tool, display the error program (step) by clicking the [Error Jump] button, and correct the program. Turn on SM321 (Start/stop SFC program) if it is off. 	Error location information	At SFC program execution
31A1H	SFC program block, step specification error	<ul style="list-style-type: none"> A non-existent SFC program block was specified. 	Stop	<ul style="list-style-type: none"> Check the detailed information (error location information) of the error by executing module diagnostics using the engineering tool, display the error program (step) by clicking the [Error Jump] button, and correct the program. Turn on SM321 (Start/stop SFC program) if it is off. Check the SFC program has existed. Check the execution status of the SFC program. 	Error location information	At instruction execution, at SFC program execution
31A2H	SFC program block, step specification error	<ul style="list-style-type: none"> The specified block exceeds the range that can be used in the SFC program. 	Stop	<ul style="list-style-type: none"> Check the detailed information (error location information) of the error by executing module diagnostics using the engineering tool, display the error program (step) by clicking the [Error Jump] button, and correct the program. Turn on SM321 (Start/stop SFC program) if it is off. 	Error location information	At instruction execution
31B1H	SFC program block, step specification error	<ul style="list-style-type: none"> A non-existent SFC program step was specified. 	Stop	<ul style="list-style-type: none"> Check the detailed information (error location information) of the error by executing module diagnostics using the engineering tool, display the error program (step) by clicking the [Error Jump] button, and correct the program. Turn on SM321 (Start/stop SFC program) if it is off. Check the SFC program has existed. Check the execution status of the SFC program. 	Error location information	At instruction execution, at SFC program execution
31B2H	SFC program block, step specification error	<ul style="list-style-type: none"> The specified step exceeds the range that can be used in the SFC program. 	Stop	<ul style="list-style-type: none"> Check the detailed information (error location information) of the error by executing module diagnostics using the engineering tool, display the error program (step) by clicking the [Error Jump] button, and correct the program. Turn on SM321 (Start/stop SFC program) if it is off. 	Error location information	At instruction execution
31B3H	SFC program block, step specification error	<ul style="list-style-type: none"> The number of simultaneous active block steps that can be specified in the SFC program exceeds the permissible value. 	Stop	<ul style="list-style-type: none"> Check the detailed information (error location information) of the error by executing module diagnostics using the engineering tool, display the error program (step) by clicking the [Error Jump] button, and correct the program. 	Error location information	At instruction execution, at SFC program execution
31B4H	SFC program block, step specification error	<ul style="list-style-type: none"> The total number of simultaneous active steps that can be specified in the SFC program exceeds the permissible value. 	Stop	<ul style="list-style-type: none"> Check the detailed information (error location information) of the error by executing module diagnostics using the engineering tool, display the error program (step) by clicking the [Error Jump] button, and correct the program. 	Error location information	At instruction execution, at SFC program execution
31B5H	SFC program block, step specification error	<ul style="list-style-type: none"> SET Sn/BLm\Sn, RST Sn/BLm\Sn, OUT Sn/BLm\Sn instructions were specified for the self step in the step operation output. 	Stop	<ul style="list-style-type: none"> Check the detailed information (error location information) of the error by executing module diagnostics using the engineering tool, display the error program (step) by clicking the [Error Jump] button, and correct the program. 	Error location information	At instruction execution

Error code	Error name	Error details and cause	Stop/continue	Action	Detailed information	Diagnostic timing
3200H	Program execution error	<ul style="list-style-type: none"> The device/label assignment does not match the device/label assignment in the program. (After the device assignment was changed, only the parameters were written to the CPU module.) 	Stop	<ul style="list-style-type: none"> If the index modification setting of the PLC parameter is changed, write the parameter and program file to the CPU module at the same time. 	Drive/file information	At power-on, at RESET
3201H	Program execution error	<ul style="list-style-type: none"> Multiple program files exist although the program setting of the CPU parameter is not set. 	Stop	<ul style="list-style-type: none"> Set the program in the program setting of the CPU parameter. Delete the unnecessary program files. 	Drive/file information	At power-on, at RESET
3202H	Program execution error	<ul style="list-style-type: none"> The program file is invalid or the file does not contain a program. "Yes" is set for the intrinsic property of a subroutine type FB, "Use MC/MCR to control EN." The SFC program is set for the CPU module that does not support the SFC program. The SFC program is set, but the CPU parameter program setting is not set to "Use". 	Stop	<ul style="list-style-type: none"> Write the correct program file. Change the intrinsic property of the subroutine type FB, "Use MC/MCR to control EN," to "No," and write the program again. Replace the CPU module with a module of a firmware version that can execute the subroutine type FB whose intrinsic property, "Use MC/MCR to control EN," is changed to "Yes." Change to a CPU module with a firmware version that supports the SFC program. Change the SFC program setting of CPU parameter to "Use" and rewrite the parameter. 	Drive/file information	At power-on, at RESET
3203H	Program execution error	<ul style="list-style-type: none"> No program file exists. 	Stop	<ul style="list-style-type: none"> Write a program file. 	Drive/file information	At power-on, at RESET
3204H	Program execution error	<ul style="list-style-type: none"> Two or more SFC programs were executed. 	Stop	<ul style="list-style-type: none"> Ensure that only one SFC program is executed. 	Drive/file information	At SFC program execution
3210H	Program execution error	<ul style="list-style-type: none"> A program with a number of steps exceeding the maximum number is written. 	Stop	<ul style="list-style-type: none"> Reduce the number of steps in the program. 	—	At power-on, at RESET
3211H	Program execution error	<ul style="list-style-type: none"> An FB program larger than the internal memory capacity was written. 	Stop	<ul style="list-style-type: none"> Reduce the number of steps in the FB program. 	—	At power-on, at RESET
3212H	Program execution error	<ul style="list-style-type: none"> No program setting is found in the parameters. 	Stop	<ul style="list-style-type: none"> Specify the program to execute in the parameters. 	—	At power-on, at RESET
3213H	Program execution error	<ul style="list-style-type: none"> The parameter set value is out of range. 	Stop	<ul style="list-style-type: none"> To use this parameter, a new firmware version of the CPU module is required. Replace the CPU module or perform version upgrade. 	Parameter information	At power-on, at RESET
3302H	Pointer setting error	<ul style="list-style-type: none"> Duplicate pointers are programmed. 	Stop	<ul style="list-style-type: none"> Modify the program to not use duplicate pointers in a program. 	Error location information	At power-on, at RESET
3320H	Interrupt pointer setting error	<ul style="list-style-type: none"> Duplicate interrupt pointers are programmed. 	Stop	<ul style="list-style-type: none"> Modify the program to not use duplicate interrupt pointers in a program. 	Error location information	At power-on, at RESET
3221H, 3222H	SFC program execution error	<ul style="list-style-type: none"> The SFC program cannot be executed. 	Stop	<ul style="list-style-type: none"> Take measures against noise. Write the SFC program again, reset the CPU module, and then run. If the same error is displayed again, there may be a hardware failure in the CPU module. Please contact your nearest Mitsubishi Electric System Service Co., Ltd., or our branch or distributor. 	Drive/file information	At power-on, at RESET, at STOP → RUN state, at SFC program execution
3340H	FOR-NEXT instruction error	<ul style="list-style-type: none"> The relationship between FOR and NEXT instructions is invalid. 	Stop	<ul style="list-style-type: none"> Make sure that FOR and NEXT instructions are each executed the same number of times. In addition, check the FOR syntax for any invalid jump instructions. 	Error location information	At END instruction execution

Error code	Error name	Error details and cause	Stop/continue	Action	Detailed information	Diagnostic timing
3341H	FOR-NEXT instruction error	<ul style="list-style-type: none"> The relationship between FOR and NEXT instructions is invalid. 	Stop	<ul style="list-style-type: none"> Make sure that FOR and NEXT instructions are each executed the same number of times. In addition, check syntax for any invalid jump instructions. 	Error location information	At END instruction execution
3342H	FOR-NEXT instruction error	<ul style="list-style-type: none"> A BREAK instruction was executed outside the FOR syntax. 	Stop	<ul style="list-style-type: none"> The BREAK instruction must be executed inside the FOR syntax. 	Error location information	At instruction execution
3360H	Nesting depth error	<ul style="list-style-type: none"> The number of nesting levels of subroutine calls is invalid. 	Stop	<ul style="list-style-type: none"> Make sure that the number of nesting levels is 16 or lower. In addition, check subroutine programs for any invalid jump instructions. 	Error location information	At instruction execution
3361H	Nesting depth error	<ul style="list-style-type: none"> The number of nesting levels of FOR instructions is invalid. 	Stop	<ul style="list-style-type: none"> Make sure that the number of nesting levels is 16 or lower. In addition, check the FOR syntax for any invalid jump instructions. 	Error location information	At instruction execution
3362H	Nesting depth error	<ul style="list-style-type: none"> The number of nesting levels of DI instructions is invalid. 	Continue/stop ^{*1}	<ul style="list-style-type: none"> Make sure that the number of nesting levels is 16 or lower. In addition, check the relationship between DI and EI instructions. 	Error location information	At instruction execution
3380H	Pointer execution error	<ul style="list-style-type: none"> There is no pointer to the jump destination. 	Stop	<ul style="list-style-type: none"> Specify the correct jump destination in the program. 	Error location information	At instruction execution
3381H	Pointer execution error	<ul style="list-style-type: none"> There is an END, FEND, GOEND, or STOP instruction in a subroutine program. 	Stop	<ul style="list-style-type: none"> The END, FEND, GOEND, and STOP instructions can be executed only in the main routine program. 	Error location information	At END instruction execution
3382H	Pointer execution error	<ul style="list-style-type: none"> A RET instruction was executed without a CALL or XCALL instruction executed. 	Stop	<ul style="list-style-type: none"> Check where there is any invalid jump to subroutine programs. 	Error location information	At instruction execution
33D0H	Temporary area exceeded	<ul style="list-style-type: none"> The size of allocated temporary area exceeds the maximum size. 	Stop	<ul style="list-style-type: none"> The usage of the temporary area can be reduced by setting the option of the engineering tool, "Collectively allocate temporary area to optimize the number of steps," to "No." Check the detailed information (error location information) using the module diagnostics of the engineering tool, and, if the program block displayed by Error Jump or the destination of Error Jump is a function block/function, divide the source program block into multiple program blocks. Change the CPU parameter, program capacity setting, to "128000 steps" to increase the capacity of the temporary area. (Compatible with only firmware version 1.100 or later of FX5U/FX5UC module) 	Error location information	At instruction execution
33E0H	Program structure error	<ul style="list-style-type: none"> The relationship between LD/LDI/LDP/LDF/LDPI/LDFI and ANB/ORB instructions is incorrect. 	Stop	<ul style="list-style-type: none"> Rewrite the program file. 	Error location information	At power-on, at RESET
33E1H	Program structure error	<ul style="list-style-type: none"> The relationship among MPS, MRD, and MPP is incorrect. 	Stop	<ul style="list-style-type: none"> Rewrite the program file. 	Error location information	At power-on, at RESET
33E2H	Program structure error	<ul style="list-style-type: none"> An instruction that should start from the bus line is not connected to the bus line. 	Stop	<ul style="list-style-type: none"> Rewrite the program file. 	Error location information	At power-on, at RESET
33E3H	Program structure error	<ul style="list-style-type: none"> The relationship between FOR and NEXT instructions is incorrect. 	Stop	<ul style="list-style-type: none"> Modify the program so that the mutual relationship between instructions becomes correct. 	Error location information	At power-on, at RESET
33E4H	Program structure error	<ul style="list-style-type: none"> The relationship between MC and MCR instructions is incorrect. 	Stop	<ul style="list-style-type: none"> Modify the program so that the mutual relationship between instructions becomes correct. 	Error location information	At power-on, at RESET

Error code	Error name	Error details and cause	Stop/continue	Action	Detailed information	Diagnostic timing
33E5H	Program structure error	<ul style="list-style-type: none"> The relationship between STL and other instructions is incorrect. 	Stop	<ul style="list-style-type: none"> Revise the program so that relationships between STL instruction and RETSTL instruction are correct. Revise the program so that the MC/MCR instruction is not used between STL instruction and RETSTL instruction. (Error also occurs when a macro-type FB that specifies "yes" for "use MC/MCR for EN control" from FB property, is placed between STL instruction to RETSTL instruction) Revise the program not to use STL and RETSTL instructions in interrupt program. 	Error location information	At power-on, at RESET
33E6H	Program structure error	<ul style="list-style-type: none"> An instruction or interrupt pointer that cannot be used in the main routine program is used. 	Stop	<ul style="list-style-type: none"> Modify the program so that instruction or pointer use becomes correct. 	Error location information	At power-on, at RESET
33E7H	Program structure error	<ul style="list-style-type: none"> The relationship among a global pointer, interrupt pointer, and return instruction is incorrect. 	Stop	<ul style="list-style-type: none"> Modify the program so that the mutual relationship between pointer and return instruction becomes correct. 	Error location information	At power-on, at RESET
33F1H	Program structure error	<ul style="list-style-type: none"> The program structure of the ST language, FB, and functions is invalid. 	Stop	<ul style="list-style-type: none"> Check the syntax of the ST language, FB, and functions. 	Error location information	At END instruction execution, at interrupt occurrence
33F2H	Program structure error	<ul style="list-style-type: none"> The program structure of the ST language, FB, and functions is invalid. 	Stop	<ul style="list-style-type: none"> Check the syntax of the ST language, FB, and functions. 	Error location information	At instruction execution
33F3H	Program structure error	<ul style="list-style-type: none"> More than two STL instructions for the same S number are programmed. 	Stop	<ul style="list-style-type: none"> Recheck the structure of the step ladder. 	Error location information	At power-on, at RESET, at STOP → RUN state
33F4H	Program structure error	<ul style="list-style-type: none"> A device used as an instruction operand is outside the allowable device range. 	Stop	<ul style="list-style-type: none"> Check the device range and modify the program. 	Error location information	At power-on, at RESET, at STOP → RUN state
33F5H	Program structure error	<ul style="list-style-type: none"> The step ladder instruction is programmed in the project for which the SFC program setting of the CPU parameter is set to "Use". 	Stop	<ul style="list-style-type: none"> The SFC program cannot be programmed at the same time as the step ladder instruction (STL, RETSTL) or initial state instruction (IST). Delete the instruction, or delete the SFC program and change the SFC program settings. 	Error location information	At power-on, at RESET, at STOP → RUN state
3400H	Operation error	<ul style="list-style-type: none"> A value of 0 was input as a divisor in an applied instruction. 	Continue/stop ^{*1}	<ul style="list-style-type: none"> Review the data specified as the divisor in the applied instruction. 	Error location information	At instruction execution
3401H	Operation error	<ul style="list-style-type: none"> Data that cannot be converted was input in an applied instruction. 	Continue/stop ^{*1}	<ul style="list-style-type: none"> Review the data specified in the applied instruction. 	Error location information	At instruction execution
3402H	Operation error	<ul style="list-style-type: none"> A value of -0, a denormalized number, a non-number, or ±∞ was input in an applied instruction. 	Continue/stop ^{*1}	<ul style="list-style-type: none"> Review the data specified in the applied instruction. 	Error location information	At instruction execution
3403H	Operation error	<ul style="list-style-type: none"> An overflow occurred in an applied instruction. 	Continue/stop ^{*1}	<ul style="list-style-type: none"> Review the data specified in the applied instruction. 	Error location information	At instruction execution
3404H	Operation error	<ul style="list-style-type: none"> A string that is not supported in the instruction was specified. 	Continue/stop ^{*1}	<ul style="list-style-type: none"> Review the data specified in the applied instruction. 	Error location information	At instruction execution
3405H	Operation error	<ul style="list-style-type: none"> Data that is outside the allowable range was input in an applied instruction. 	Continue/stop ^{*1}	<ul style="list-style-type: none"> Review the data specified in the applied instruction. 	Error location information	At instruction execution
3406H	Operation error	<ul style="list-style-type: none"> The output result is outside the allowable device range in an applied instruction. 	Continue/stop ^{*1}	<ul style="list-style-type: none"> Review the data specified in the applied instruction. 	Error location information	At instruction execution



Error code	Error name	Error details and cause	Stop/continue	Action	Detailed information	Diagnostic timing
3420H	Operation error	<ul style="list-style-type: none"> A module access device is specified to both (s) and (d) in a BMOV instruction or BLKMOVB instruction. 	Continue/stop ^{*1}	<ul style="list-style-type: none"> Review the device specified in the BMOV instruction or BLKMOVB instruction. 	Error location information	At instruction execution
3421H	Operation error	<ul style="list-style-type: none"> When writing data to the data memory by using the SP.DEVST instruction, the number of writes per day exceeded the number set in SD771. The value set in SD771 is out of range. 	Continue/stop ^{*1}	<ul style="list-style-type: none"> Check if the SP.DEVST instruction is used correctly. Execute the SP.DEVST instruction again on another day, or change the value in SD771. Set the value in SD771 within the settable range. 	Error location information	At instruction execution
3426H	Operation error	<ul style="list-style-type: none"> Two or more "*" are specified in the specified file name (until the period) or in the extension. "*" and "?" are mixed in the specified file name (until the period) or extension the extension. A wildcard specification character ("*", "?") is included in a part that cannot be specified. The specified file name has a file extension that cannot be transferred. The file name is not specified. The delimiter of the drive number is specified with symbol other than ":" or "/". 	Continue/stop ^{*1}	<ul style="list-style-type: none"> Check how to specify wildcard specification characters. Check the file extensions which can be transferred. Specify the file name. Specify the drive number delimiter with ":" or "/". 	Error location information	At instruction execution
3427H	Operation error	<ul style="list-style-type: none"> The combination of execution/completion type and data type specified in (d1) of the control data for the SP.FREAD instruction and SP.FWRITE instruction is not allowable. 	Continue/stop ^{*1}	Check the detailed information (error location information) of the error by executing module diagnostics using the engineering tool, display the error program (step) by clicking the [Error Jump] button, and check the program that can be specified.	Error location information	At instruction execution
3430H	Operation error	<ul style="list-style-type: none"> The instruction was executed without setting the necessary parameters for executing the instruction. 	Continue/stop ^{*1}	<ul style="list-style-type: none"> Set the necessary parameters to execute the instruction. 	Error location information	At instruction execution
3500H	Operation error	<ul style="list-style-type: none"> A value outside the allowable range was set to the sampling time (TS). 	Continue/stop ^{*1}	<ul style="list-style-type: none"> Check the contents of the parameters. 	Error location information	At instruction execution
3502H	Operation error	<ul style="list-style-type: none"> A value outside the allowable range was set to the input filter constant (α). 	Continue/stop ^{*1}	<ul style="list-style-type: none"> Check the contents of the parameters. 	Error location information	At instruction execution
3503H	Operation error	<ul style="list-style-type: none"> A value outside the allowable range was set to the proportional gain (KP). 	Continue/stop ^{*1}	<ul style="list-style-type: none"> Check the contents of the parameters. 	Error location information	At instruction execution
3504H	Operation error	<ul style="list-style-type: none"> A value outside the allowable range was set to the integral time (TI). 	Continue/stop ^{*1}	<ul style="list-style-type: none"> Check the contents of the parameters. 	Error location information	At instruction execution
3505H	Operation error	<ul style="list-style-type: none"> A value outside the allowable range was set to the derivative gain (KD). 	Continue/stop ^{*1}	<ul style="list-style-type: none"> Check the contents of the parameters. 	Error location information	At instruction execution
3506H	Operation error	<ul style="list-style-type: none"> A value outside the allowable range was set to the derivative time (TD). 	Continue/stop ^{*1}	<ul style="list-style-type: none"> Check the contents of the parameters. 	Error location information	At instruction execution
350AH	Operation error	<ul style="list-style-type: none"> The sampling time is shorter than the scan time. 	Continue/stop ^{*1}	<ul style="list-style-type: none"> The operation is continued in the condition "sampling time (TS) = cyclic time (scan time)". 	Error location information	At instruction execution
350CH	Operation error	<ul style="list-style-type: none"> The variation of measured value is greater than the maximum value or lower than the minimum value. 	Continue/stop ^{*1}	<ul style="list-style-type: none"> The operation is continued with the maximum or minimum value. 	Error location information	At instruction execution

Error code	Error name	Error details and cause	Stop/continue	Action	Detailed information	Diagnostic timing
350DH	Operation error	<ul style="list-style-type: none"> The deviation is greater than the maximum value or lower than the minimum value. 	Continue/stop ^{*1}	<ul style="list-style-type: none"> The operation is continued with the maximum or minimum value. 	Error location information	At instruction execution
350EH	Operation error	<ul style="list-style-type: none"> The integral result is greater than the maximum value or lower than the minimum value. 	Continue/stop ^{*1}	<ul style="list-style-type: none"> The operation is continued with the maximum or minimum value. 	Error location information	At instruction execution
350FH	Operation error	<ul style="list-style-type: none"> The derivative value is greater than the maximum value or lower than the minimum value due to the derivative gain (KP). 	Continue/stop ^{*1}	<ul style="list-style-type: none"> The operation is continued with the maximum or minimum value. 	Error location information	At instruction execution
3510H	Operation error	<ul style="list-style-type: none"> The derivative result is greater than the maximum value or lower than the minimum value. 	Continue/stop ^{*1}	<ul style="list-style-type: none"> The operation is continued with the maximum or minimum value. 	Error location information	At instruction execution
3511H	Operation error	<ul style="list-style-type: none"> The PID operation result is greater than the maximum value or lower than the minimum value. 	Continue/stop ^{*1}	<ul style="list-style-type: none"> The operation is continued with the maximum or minimum value. 	Error location information	At instruction execution
3512H	Operation error	<ul style="list-style-type: none"> The output upper limit value is lower than the output lower limit value. 	Continue/stop ^{*1}	<ul style="list-style-type: none"> Calculation is continued with the output upper limit value and output lower limit value transposed. 	Error location information	At instruction execution
3513H	Operation error	<ul style="list-style-type: none"> The input variation alarm set value or output variation alarm set value is outside the allowable range. 	Continue/stop ^{*1}	<ul style="list-style-type: none"> The operation is continued without alarm output. 	Error location information	At instruction execution
3514H	Operation error	<ul style="list-style-type: none"> The auto tuning result in the step response method is abnormal. The deviation at end of auto tuning is 1/3 or less of the deviation at start of auto tuning. 	Continue/stop ^{*1}	<ul style="list-style-type: none"> Check the measured value and target value, and then execute auto tuning again. 	Error location information	At instruction execution
3515H	Operation error	<ul style="list-style-type: none"> The operation direction estimated from the measured value at the start of auto tuning in the step response method was different from the actual operation direction of the output during auto tuning. 	Continue/stop ^{*1}	<ul style="list-style-type: none"> Correct the relationship among the target value, output value for auto tuning, and the measured value, and then execute auto tuning again. 	Error location information	At instruction execution
3516H	Operation error	<ul style="list-style-type: none"> Because the set value fluctuated during auto tuning in the step response method, auto tuning was not executed correctly. 	Continue/stop ^{*1}	<ul style="list-style-type: none"> Set the sampling time to a value larger than the output change cycle, or set a larger value for the input filter constant. After changing the setting, execute auto tuning again. 	Error location information	At instruction execution
3517H	Operation error	<ul style="list-style-type: none"> The output set value upper limit for auto tuning is lower than the lower limit. 	Continue/stop ^{*1}	<ul style="list-style-type: none"> Verify that the target setting contents are correct. 	Error location information	At instruction execution
3518H	Operation error	<ul style="list-style-type: none"> A value outside the allowable range was set to the PV threshold for auto tuning. 	Continue/stop ^{*1}	<ul style="list-style-type: none"> Verify that the target setting contents are correct. 	Error location information	At instruction execution
3519H	Operation error	<ul style="list-style-type: none"> Operation is not performed normally because devices occupied by the PID instruction were overwritten. 	Continue/stop ^{*1}	<ul style="list-style-type: none"> Ensure that devices occupied by PID instruction are not overwritten in the program. 	Error location information	At instruction execution
351AH	Operation error	<ul style="list-style-type: none"> The auto tuning time is longer than necessary. 	Continue/stop ^{*1}	<ul style="list-style-type: none"> Increase the difference (ULV - LLV) between the upper limit and lower limit of the output value for auto tuning, set a smaller value to the input filter constant (α), or set a smaller value to the PV threshold (SHPV) for auto tuning, and then check the result for improvement. 	Error location information	At instruction execution
351BH	Operation error	<ul style="list-style-type: none"> The variation of the measured value is too small compared with the output value. 	Continue/stop ^{*1}	<ul style="list-style-type: none"> Multiply the measured value (PV) by "10" so that the variation of the measured value will increase during auto tuning. The operation is continued with KP = 32767. 	Error location information	At instruction execution

Error code	Error name	Error details and cause	Stop/continue	Action	Detailed information	Diagnostic timing
351CH	Operation error	<ul style="list-style-type: none"> The auto tuning time is longer than necessary. 	Continue/stop ^{*1}	<ul style="list-style-type: none"> Increase the difference (ULV - LLV) between the upper limit and lower limit of the output value for auto tuning, set a smaller value to the input filter constant (α), or set a smaller value to the PV threshold (SHPV) for auto tuning, and then check the result for improvement. The operation is continued with KP = 32767. 	Error location information	At instruction execution
351DH	Operation error	<ul style="list-style-type: none"> The auto tuning time is longer than necessary. 	Continue/stop ^{*1}	<ul style="list-style-type: none"> Increase the difference (ULV - LLV) between the upper limit and lower limit of the output value for auto tuning, set a smaller value to the input filter constant (α), or set a smaller value to the PV threshold (SHPV) for auto tuning, and then check the result for improvement. The operation is continued with KP = 32767. 	Error location information	At instruction execution
351EH	Operation error	<ul style="list-style-type: none"> An out-of-range value is set for the timeout time setting value after maximum ramp (R) detection. 	Continue/stop ^{*1}	<ul style="list-style-type: none"> Check the contents of the parameters. 	Error location information	At instruction execution
3580H	Operation error	<ul style="list-style-type: none"> An instruction that cannot be used in an interrupt routine program is used. 	Continue/stop ^{*1}	<ul style="list-style-type: none"> Modify the program so that no instruction whose use is disabled by the interrupt routine program is used. 	Error location information	At instruction execution
3581H	Operation error	<ul style="list-style-type: none"> Modules subsequent to the bus conversion module are using an operand that cannot be used. 	Continue/stop ^{*1}	<ul style="list-style-type: none"> Modify the program so that no operand whose use is disabled for modules subsequent to the bus conversion module is used. 	Error location information	At instruction execution
3582H	Operation error	<ul style="list-style-type: none"> An instruction that cannot be used in an interrupt routine program is used. 	Continue/stop ^{*1}	<ul style="list-style-type: none"> Modify the program so that no instruction whose use is disabled by the interrupt routine program is used. 	Error location information	At instruction execution
3583H	Operation error	<ul style="list-style-type: none"> A CPU module with a serial No. incompatible with the function was used. 	Continue/stop ^{*1}	<ul style="list-style-type: none"> Use a CPU module with a serial No. compatible with the function. For details, refer to the manual. 	Error location information	At instruction execution
3584H	Operation error	<ul style="list-style-type: none"> The writing failed because the write protect switch of the SD memory card is enabled (the writing is prohibited). 	Continue/stop ^{*1}	<ul style="list-style-type: none"> Disable the write protect switch of the SD memory card. 	Error location information	At instruction execution
3585H	Operation error	<ul style="list-style-type: none"> The data exceeded the maximum data storage capacity. 	Continue/stop ^{*1}	<ul style="list-style-type: none"> Increase the SD memory card free space capacity, and execute the function again. Delete files in the SD memory card, and execute the function again. Delete the backup data in the SD memory card, and execute the function again. 	Error location information	At instruction execution
3586H	Operation error	<ul style="list-style-type: none"> The SD memory card has not been inserted. The SD memory card turned to disable status by SM606 (SD memory card forcibly disable command). 	Continue/stop ^{*1}	<ul style="list-style-type: none"> Insert or re-insert an SD memory card, and execute the function again. Release the SD memory card disable status, and execute the function again. 	Error location information	At instruction execution
3587H	Operation error	<ul style="list-style-type: none"> An error was found in the data of the file. Writing/reading to the SD memory card did not finished correctly. 	Continue/stop ^{*1}	<ul style="list-style-type: none"> Re-create the file. Check that the SD memory card is mounted correctly, and execute the function again. Re-insert the SD memory card, and execute the function again. 	Error location information	At instruction execution
3588H	Operation error	<ul style="list-style-type: none"> The specified file does not exist. 	Continue/stop ^{*1}	<ul style="list-style-type: none"> Check the file, and execute the function again. 	Error location information	At instruction execution

Error code	Error name	Error details and cause	Stop/continue	Action	Detailed information	Diagnostic timing
3600H	Operation error	<ul style="list-style-type: none"> The channel specified by instructions using communication functions or high-speed I/O does not have the appropriate parameter. The appropriate parameters are set for the specified channel, but the appropriate board, adapter and module are not installed. 	Continue/stop ^{*1}	<ul style="list-style-type: none"> Verify that the parameter setting of the channel specified by instructions using communication functions or high-speed I/O is correct. Verify that the appropriate board, adapter and module are installed on the specified channel. 	Error location information	At instruction execution
3611H	CH1 pulse width, period setting error	<ul style="list-style-type: none"> The value of the special register to set the pulse width and cycle of the PWM/DPWM instruction is abnormal. 	Continue/stop ^{*1}	<ul style="list-style-type: none"> Modify the value of the special register and restart PWM. 	Error location information and system configuration information	At END instruction execution
3612H	CH2 pulse width, period setting error	<ul style="list-style-type: none"> The value of the special register to set the pulse width and cycle of the PWM/DPWM instruction is abnormal. 	Continue/stop ^{*1}	<ul style="list-style-type: none"> Modify the value of the special register and restart PWM. 	Error location information and system configuration information	At END instruction execution
3613H	CH3 pulse width, period setting error	<ul style="list-style-type: none"> The value of the special register to set the pulse width and cycle of the PWM/DPWM instruction is abnormal. 	Continue/stop ^{*1}	<ul style="list-style-type: none"> Modify the value of the special register and restart PWM. 	Error location information and system configuration information	At END instruction execution
3614H	CH4 pulse width, period setting error	<ul style="list-style-type: none"> The value of the special register to set the pulse width and cycle of the PWM/DPWM instruction is abnormal. 	Continue/stop ^{*1}	<ul style="list-style-type: none"> Modify the value of the special register and restart PWM. 	Error location information and system configuration information	At END instruction execution
3615H	CH5 pulse width, period setting error	<ul style="list-style-type: none"> The value of the special register to set the pulse width and cycle of the PWM/DPWM instruction is abnormal. 	Continue/stop ^{*1}	<ul style="list-style-type: none"> Modify the value of the special register and restart PWM. 	Error location information and system configuration information	At END instruction execution
3616H	CH6 pulse width, period setting error	<ul style="list-style-type: none"> The value of the special register to set the pulse width and cycle of the PWM/DPWM instruction is abnormal. 	Continue/stop ^{*1}	<ul style="list-style-type: none"> Modify the value of the special register and restart PWM. 	Error location information and system configuration information	At END instruction execution
3617H	CH7 pulse width, period setting error	<ul style="list-style-type: none"> The value of the special register to set the pulse width and cycle of the PWM/DPWM instruction is abnormal. 	Continue/stop ^{*1}	<ul style="list-style-type: none"> Modify the value of the special register and restart PWM. 	Error location information and system configuration information	At END instruction execution
3618H	CH8 pulse width, period setting error	<ul style="list-style-type: none"> The value of the special register to set the pulse width and cycle of the PWM/DPWM instruction is abnormal. 	Continue/stop ^{*1}	<ul style="list-style-type: none"> Modify the value of the special register and restart PWM. 	Error location information and system configuration information	At END instruction execution
3619H	CH9 pulse width, period setting error	<ul style="list-style-type: none"> The value of the special register to set the pulse width and cycle of the PWM/DPWM instruction is abnormal. 	Continue/stop ^{*1}	<ul style="list-style-type: none"> Modify the value of the special register and restart PWM. 	Error location information and system configuration information	At END instruction execution
361AH	CH10 pulse width, period setting error	<ul style="list-style-type: none"> The value of the special register to set the pulse width and cycle of the PWM/DPWM instruction is abnormal. 	Continue/stop ^{*1}	<ul style="list-style-type: none"> Modify the value of the special register and restart PWM. 	Error location information and system configuration information	At END instruction execution
361BH	CH11 pulse width, period setting error	<ul style="list-style-type: none"> The value of the special register to set the pulse width and cycle of the PWM/DPWM instruction is abnormal. 	Continue/stop ^{*1}	<ul style="list-style-type: none"> Modify the value of the special register and restart PWM. 	Error location information and system configuration information	At END instruction execution

Error code	Error name	Error details and cause	Stop/continue	Action	Detailed information	Diagnostic timing
361CH	CH12 pulse width, period setting error	<ul style="list-style-type: none"> The value of the special register to set the pulse width and cycle of the PWM/DPWM instruction is abnormal. 	Continue/stop ^{*1}	<ul style="list-style-type: none"> Modify the value of the special register and restart PWM. 	Error location information and system configuration information	At END instruction execution
3621H	Axis 1 limit detection error	<ul style="list-style-type: none"> Both the forward and reverse limits were detected at the time of zero return or the limit of the moving direction was detected after the near-point dog was detected. 	Continue/stop ^{*1}	<ul style="list-style-type: none"> Recheck the relationship between the near-point dog and limits. 	Error location information and system configuration information	At END instruction execution, at instruction execution
3622H	Axis 2 limit detection error	<ul style="list-style-type: none"> Both the forward and reverse limits were detected at the time of zero return or the limit of the moving direction was detected after the near-point dog was detected. 	Continue/stop ^{*1}	<ul style="list-style-type: none"> Recheck the relationship between the near-point dog and limits. 	Error location information and system configuration information	At END instruction execution, at instruction execution
3623H	Axis 3 limit detection error	<ul style="list-style-type: none"> Both the forward and reverse limits were detected at the time of zero return or the limit of the moving direction was detected after the near-point dog was detected. 	Continue/stop ^{*1}	<ul style="list-style-type: none"> Recheck the relationship between the near-point dog and limits. 	Error location information and system configuration information	At END instruction execution, at instruction execution
3624H	Axis 4 limit detection error	<ul style="list-style-type: none"> Both the forward and reverse limits were detected at the time of zero return or the limit of the moving direction was detected after the near-point dog was detected. 	Continue/stop ^{*1}	<ul style="list-style-type: none"> Recheck the relationship between the near-point dog and limits. 	Error location information and system configuration information	At END instruction execution, at instruction execution
3625H	Axis 5 limit detection error	<ul style="list-style-type: none"> Both the forward and reverse limits were detected at the time of zero return or the limit of the moving direction was detected after the near-point dog was detected. 	Continue/stop ^{*1}	<ul style="list-style-type: none"> Recheck the relationship between the near-point dog and limits. 	Error location information and system configuration information	At END instruction execution, at instruction execution
3626H	Axis 6 limit detection error	<ul style="list-style-type: none"> Both the forward and reverse limits were detected at the time of zero return or the limit of the moving direction was detected after the near-point dog was detected. 	Continue/stop ^{*1}	<ul style="list-style-type: none"> Recheck the relationship between the near-point dog and limits. 	Error location information and system configuration information	At END instruction execution, at instruction execution
3627H	Axis 7 limit detection error	<ul style="list-style-type: none"> Both the forward and reverse limits were detected at the time of zero return or the limit of the moving direction was detected after the near-point dog was detected. 	Continue/stop ^{*1}	<ul style="list-style-type: none"> Recheck the relationship between the near-point dog and limits. 	Error location information and system configuration information	At END instruction execution, at instruction execution
3628H	Axis 8 limit detection error	<ul style="list-style-type: none"> Both the forward and reverse limits were detected at the time of zero return or the limit of the moving direction was detected after the near-point dog was detected. 	Continue/stop ^{*1}	<ul style="list-style-type: none"> Recheck the relationship between the near-point dog and limits. 	Error location information and system configuration information	At END instruction execution, at instruction execution
3629H	Axis 9 limit detection error	<ul style="list-style-type: none"> Both the forward and reverse limits were detected at the time of zero return or the limit of the moving direction was detected after the near-point dog was detected. 	Continue/stop ^{*1}	<ul style="list-style-type: none"> Recheck the relationship between the near-point dog and limits. 	Error location information and system configuration information	At END instruction execution, at instruction execution
362AH	Axis 10 limit detection error	<ul style="list-style-type: none"> Both the forward and reverse limits were detected at the time of zero return or the limit of the moving direction was detected after the near-point dog was detected. 	Continue/stop ^{*1}	<ul style="list-style-type: none"> Recheck the relationship between the near-point dog and limits. 	Error location information and system configuration information	At END instruction execution, at instruction execution

Error code	Error name	Error details and cause	Stop/continue	Action	Detailed information	Diagnostic timing
362BH	Axis 11 limit detection error	<ul style="list-style-type: none"> Both the forward and reverse limits were detected at the time of zero return or the limit of the moving direction was detected after the near-point dog was detected. 	Continue/stop ^{*1}	<ul style="list-style-type: none"> Recheck the relationship between the near-point dog and limits. 	Error location information and system configuration information	At END instruction execution, at instruction execution
362CH	Axis 12 limit detection error	<ul style="list-style-type: none"> Both the forward and reverse limits were detected at the time of zero return or the limit of the moving direction was detected after the near-point dog was detected. 	Continue/stop ^{*1}	<ul style="list-style-type: none"> Recheck the relationship between the near-point dog and limits. 	Error location information and system configuration information	At END instruction execution, at instruction execution
3631H	Axis 1 positioning address error	<ul style="list-style-type: none"> The 32-bit range was exceeded when the unit of the positioning address was converted. The 32-bit range was exceeded when the unit of the zero-point address was converted. The total transfer distance before and after the interrupt of the DVIT/DDVIT instruction or 1-speed positioning with interruption exceeded 7FFFFFFH. Or, when the operation was started, the positioning address was set to 0. Pulses of 7FFFFFFH or greater are needed to specify an absolute address. 	Continue/stop ^{*1}	<ul style="list-style-type: none"> Start the positioning within specifications. 	Error location information and system configuration information	At END instruction execution, at interrupt occurrence
3632H	Axis 2 positioning address error	<ul style="list-style-type: none"> The 32-bit range was exceeded when the unit of the positioning address was converted. The 32-bit range was exceeded when the unit of the zero-point address was converted. The total transfer distance before and after the interrupt of the DVIT/DDVIT instruction or 1-speed positioning with interruption exceeded 7FFFFFFH. Or, when the operation was started, the positioning address was set to 0. Pulses of 7FFFFFFH or greater are needed to specify an absolute address. 	Continue/stop ^{*1}	<ul style="list-style-type: none"> Start the positioning within specifications. 	Error location information and system configuration information	At END instruction execution, at interrupt occurrence
3633H	Axis 3 positioning address error	<ul style="list-style-type: none"> The 32-bit range was exceeded when the unit of the positioning address was converted. The 32-bit range was exceeded when the unit of the zero-point address was converted. The total transfer distance before and after the interrupt of the DVIT/DDVIT instruction or 1-speed positioning with interruption exceeded 7FFFFFFH. Or, when the operation was started, the positioning address was set to 0. Pulses of 7FFFFFFH or greater are needed to specify an absolute address. 	Continue/stop ^{*1}	<ul style="list-style-type: none"> Start the positioning within specifications. 	Error location information and system configuration information	At END instruction execution, at interrupt occurrence



Error code	Error name	Error details and cause	Stop/continue	Action	Detailed information	Diagnostic timing
3634H	Axis 4 positioning address error	<ul style="list-style-type: none"> The 32-bit range was exceeded when the unit of the positioning address was converted. The 32-bit range was exceeded when the unit of the zero-point address was converted. The total transfer distance before and after the interrupt of the DVIT/DDVIT instruction or 1-speed positioning with interruption exceeded 7FFFFFFFH. Or, when the operation was started, the positioning address was set to 0. Pulses of 7FFFFFFFH or greater are needed to specify an absolute address. 	Continue/stop ^{*1}	<ul style="list-style-type: none"> Start the positioning within specifications. 	Error location information and system configuration information	At END instruction execution, at interrupt occurrence
3635H	Axis 5 positioning address error	<ul style="list-style-type: none"> The 32-bit range was exceeded when the unit of the positioning address was converted. The 32-bit range was exceeded when the unit of the zero-point address was converted. The total transfer distance before and after the interrupt of the DVIT/DDVIT instruction or 1-speed positioning with interruption exceeded 7FFFFFFFH. Or, when the operation was started, the positioning address was set to 0. Pulses of 7FFFFFFFH or greater are needed to specify an absolute address. 	Continue/stop ^{*1}	<ul style="list-style-type: none"> Start the positioning within specifications. 	Error location information and system configuration information	At END instruction execution, at interrupt occurrence
3636H	Axis 6 positioning address error	<ul style="list-style-type: none"> The 32-bit range was exceeded when the unit of the positioning address was converted. The 32-bit range was exceeded when the unit of the zero-point address was converted. The total transfer distance before and after the interrupt of the DVIT/DDVIT instruction or 1-speed positioning with interruption exceeded 7FFFFFFFH. Or, when the operation was started, the positioning address was set to 0. Pulses of 7FFFFFFFH or greater are needed to specify an absolute address. 	Continue/stop ^{*1}	<ul style="list-style-type: none"> Start the positioning within specifications. 	Error location information and system configuration information	At END instruction execution, at interrupt occurrence
3637H	Axis7 positioning address error	<ul style="list-style-type: none"> The 32-bit range was exceeded when the unit of the positioning address was converted. The 32-bit range was exceeded when the unit of the zero-point address was converted. The total transfer distance before and after the interrupt of the DVIT/DDVIT instruction or 1-speed positioning with interruption exceeded 7FFFFFFFH. Or, when the operation was started, the positioning address was set to 0. Pulses of 7FFFFFFFH or greater are needed to specify an absolute address. 	Continue/stop ^{*1}	<ul style="list-style-type: none"> Start the positioning within specifications. 	Error location information and system configuration information	At END instruction execution, at interrupt occurrence

Error code	Error name	Error details and cause	Stop/continue	Action	Detailed information	Diagnostic timing
3638H	Axis 8 positioning address error	<ul style="list-style-type: none"> The 32-bit range was exceeded when the unit of the positioning address was converted. The 32-bit range was exceeded when the unit of the zero-point address was converted. The total transfer distance before and after the interrupt of the DVIT/DDVIT instruction or 1-speed positioning with interruption exceeded 7FFFFFFFH. Or, when the operation was started, the positioning address was set to 0. Pulses of 7FFFFFFFH or greater are needed to specify an absolute address. 	Continue/stop ^{*1}	<ul style="list-style-type: none"> Start the positioning within specifications. 	Error location information and system configuration information	At END instruction execution, at interrupt occurrence
3639H	Axis 9 positioning address error	<ul style="list-style-type: none"> The 32-bit range was exceeded when the unit of the positioning address was converted. The 32-bit range was exceeded when the unit of the zero-point address was converted. The total transfer distance before and after the interrupt of the DVIT/DDVIT instruction or 1-speed positioning with interruption exceeded 7FFFFFFFH. Or, when the operation was started, the positioning address was set to 0. Pulses of 7FFFFFFFH or greater are needed to specify an absolute address. 	Continue/stop ^{*1}	<ul style="list-style-type: none"> Start the positioning within specifications. 	Error location information and system configuration information	At END instruction execution, at interrupt occurrence
363AH	Axis 10 positioning address error	<ul style="list-style-type: none"> The 32-bit range was exceeded when the unit of the positioning address was converted. The 32-bit range was exceeded when the unit of the zero-point address was converted. The total transfer distance before and after the interrupt of the DVIT/DDVIT instruction or 1-speed positioning with interruption exceeded 7FFFFFFFH. Or, when the operation was started, the positioning address was set to 0. Pulses of 7FFFFFFFH or greater are needed to specify an absolute address. 	Continue/stop ^{*1}	<ul style="list-style-type: none"> Start the positioning within specifications. 	Error location information and system configuration information	At END instruction execution, at interrupt occurrence
363BH	Axis 11 positioning address error	<ul style="list-style-type: none"> The 32-bit range was exceeded when the unit of the positioning address was converted. The 32-bit range was exceeded when the unit of the zero-point address was converted. The total transfer distance before and after the interrupt of the DVIT/DDVIT instruction or 1-speed positioning with interruption exceeded 7FFFFFFFH. Or, when the operation was started, the positioning address was set to 0. Pulses of 7FFFFFFFH or greater are needed to specify an absolute address. 	Continue/stop ^{*1}	<ul style="list-style-type: none"> Start the positioning within specifications. 	Error location information and system configuration information	At END instruction execution, at interrupt occurrence



Error code	Error name	Error details and cause	Stop/continue	Action	Detailed information	Diagnostic timing
363CH	Axis 12 positioning address error	<ul style="list-style-type: none"> The 32-bit range was exceeded when the unit of the positioning address was converted. The 32-bit range was exceeded when the unit of the zero-point address was converted. The total transfer distance before and after the interrupt of the DVIT/DDVIT instruction or 1-speed positioning with interruption exceeded 7FFFFFFH. Or, when the operation was started, the positioning address was set to 0. Pulses of 7FFFFFFH or greater are needed to specify an absolute address. 	Continue/stop ^{*1}	<ul style="list-style-type: none"> Start the positioning within specifications. 	Error location information and system configuration information	At END instruction execution, at interrupt occurrence
3641H	Axis 1 command speed error	<ul style="list-style-type: none"> The 32-bit range was exceeded when the unit of the command speed was converted. When the positioning was started, the command speed was set to 0. 	Continue/stop ^{*1}	<ul style="list-style-type: none"> Start the positioning within specifications. 	Error location information and system configuration information	At instruction execution
3642H	Axis 2 command speed error	<ul style="list-style-type: none"> The 32-bit range was exceeded when the unit of the command speed was converted. When the positioning was started, the command speed was set to 0. 	Continue/stop ^{*1}	<ul style="list-style-type: none"> Start the positioning within specifications. 	Error location information and system configuration information	At instruction execution
3643H	Axis 3 command speed error	<ul style="list-style-type: none"> The 32-bit range was exceeded when the unit of the command speed was converted. When the positioning was started, the command speed was set to 0. 	Continue/stop ^{*1}	<ul style="list-style-type: none"> Start the positioning within specifications. 	Error location information and system configuration information	At instruction execution
3644H	Axis 4 command speed error	<ul style="list-style-type: none"> The 32-bit range was exceeded when the unit of the command speed was converted. When the positioning was started, the command speed was set to 0. 	Continue/stop ^{*1}	<ul style="list-style-type: none"> Start the positioning within specifications. 	Error location information and system configuration information	At instruction execution
3645H	Axis 5 command speed error	<ul style="list-style-type: none"> The 32-bit range was exceeded when the unit of the command speed was converted. When the positioning was started, the command speed was set to 0. 	Continue/stop ^{*1}	<ul style="list-style-type: none"> Start the positioning within specifications. 	Error location information and system configuration information	At instruction execution
3646H	Axis 6 command speed error	<ul style="list-style-type: none"> The 32-bit range was exceeded when the unit of the command speed was converted. When the positioning was started, the command speed was set to 0. 	Continue/stop ^{*1}	<ul style="list-style-type: none"> Start the positioning within specifications. 	Error location information and system configuration information	At instruction execution
3647H	Axis 7 command speed error	<ul style="list-style-type: none"> The 32-bit range was exceeded when the unit of the command speed was converted. When the positioning was started, the command speed was set to 0. 	Continue/stop ^{*1}	<ul style="list-style-type: none"> Start the positioning within specifications. 	Error location information and system configuration information	At instruction execution
3648H	Axis 8 command speed error	<ul style="list-style-type: none"> The 32-bit range was exceeded when the unit of the command speed was converted. When the positioning was started, the command speed was set to 0. 	Continue/stop ^{*1}	<ul style="list-style-type: none"> Start the positioning within specifications. 	Error location information and system configuration information	At instruction execution

Error code	Error name	Error details and cause	Stop/continue	Action	Detailed information	Diagnostic timing
3649H	Axis 9 command speed error	<ul style="list-style-type: none"> The 32-bit range was exceeded when the unit of the command speed was converted. When the positioning was started, the command speed was set to 0. 	Continue/stop ^{*1}	<ul style="list-style-type: none"> Start the positioning within specifications. 	Error location information and system configuration information	At instruction execution
364AH	Axis 10 command speed error	<ul style="list-style-type: none"> The 32-bit range was exceeded when the unit of the command speed was converted. When the positioning was started, the command speed was set to 0. 	Continue/stop ^{*1}	<ul style="list-style-type: none"> Start the positioning within specifications. 	Error location information and system configuration information	At instruction execution
364BH	Axis 11 command speed error	<ul style="list-style-type: none"> The 32-bit range was exceeded when the unit of the command speed was converted. When the positioning was started, the command speed was set to 0. 	Continue/stop ^{*1}	<ul style="list-style-type: none"> Start the positioning within specifications. 	Error location information and system configuration information	At instruction execution
364CH	Axis 12 command speed error	<ul style="list-style-type: none"> The 32-bit range was exceeded when the unit of the command speed was converted. When the positioning was started, the command speed was set to 0. 	Continue/stop ^{*1}	<ul style="list-style-type: none"> Start the positioning within specifications. 	Error location information and system configuration information	At instruction execution
3651H	Axis 1 error stop (deceleration stop)	<ul style="list-style-type: none"> When pulses were being output or positioning was starting, the PLC decelerated and stopped the pulse output due to the limit of the moving direction or writing during RUN. (The PLSY/DPLSY instruction stops pulse output immediately at both limits.) When pulses were being output or positioning was starting, the PLC decelerated and stopped the pulse output by the pulse decelerate and stop command. When pulses were being output, the command speed was changed to 0. When pulses were being output, RUN→PAUSE/RUN→STOP operation was executed. 	Continue/stop ^{*1}	<ul style="list-style-type: none"> Eliminate the error that has caused the stop and restart the positioning. 	Error location information and system configuration information	At END instruction execution, at instruction execution
3652H	Axis 2 error stop (deceleration stop)	<ul style="list-style-type: none"> When pulses were being output or positioning was starting, the PLC decelerated and stopped the pulse output due to the limit of the moving direction or writing during RUN. (The PLSY/DPLSY instruction stops pulse output immediately at both limits.) When pulses were being output or positioning was starting, the PLC decelerated and stopped the pulse output by the pulse decelerate and stop command. When pulses were being output, the command speed was changed to 0. When pulses were being output, RUN→PAUSE/RUN→STOP operation was executed. 	Continue/stop ^{*1}	<ul style="list-style-type: none"> Eliminate the error that has caused the stop and restart the positioning. 	Error location information and system configuration information	At END instruction execution, at instruction execution

Error code	Error name	Error details and cause	Stop/continue	Action	Detailed information	Diagnostic timing
3653H	Axis 3 error stop (deceleration stop)	<ul style="list-style-type: none"> When pulses were being output or positioning was starting, the PLC decelerated and stopped the pulse output due to the limit of the moving direction or writing during RUN. (The PLSY/DPLSY instruction stops pulse output immediately at both limits.) When pulses were being output or positioning was starting, the PLC decelerated and stopped the pulse output by the pulse decelerate and stop command. When pulses were being output, the command speed was changed to 0. When pulses were being output, RUN→PAUSE/RUN→STOP operation was executed. 	Continue/stop ^{*1}	<ul style="list-style-type: none"> Eliminate the error that has caused the stop and restart the positioning. 	Error location information and system configuration information	At END instruction execution, at instruction execution
3654H	Axis 4 error stop (deceleration stop)	<ul style="list-style-type: none"> When pulses were being output or positioning was starting, the PLC decelerated and stopped the pulse output due to the limit of the moving direction or writing during RUN. (The PLSY/DPLSY instruction stops pulse output immediately at both limits.) When pulses were being output or positioning was starting, the PLC decelerated and stopped the pulse output by the pulse decelerate and stop command. When pulses were being output, the command speed was changed to 0. When pulses were being output, RUN→PAUSE/RUN→STOP operation was executed. 	Continue/stop ^{*1}	<ul style="list-style-type: none"> Eliminate the error that has caused the stop and restart the positioning. 	Error location information and system configuration information	At END instruction execution, at instruction execution
3655H	Axis 5 error stop (deceleration stop)	<ul style="list-style-type: none"> When pulses were being output or positioning was starting, the PLC decelerated and stopped the pulse output due to the limit of the moving direction or writing during RUN. (The PLSY/DPLSY instruction stops pulse output immediately at both limits.) When pulses were being output or positioning was starting, the PLC decelerated and stopped the pulse output by the pulse decelerate and stop command. When pulses were being output, the command speed was changed to 0. When pulses were being output, RUN→PAUSE/RUN→STOP operation was executed. 	Continue/stop ^{*1}	<ul style="list-style-type: none"> Eliminate the error that has caused the stop and restart the positioning. 	Error location information and system configuration information	At END instruction execution, at instruction execution

Error code	Error name	Error details and cause	Stop/continue	Action	Detailed information	Diagnostic timing
3656H	Axis 6 error stop (deceleration stop)	<ul style="list-style-type: none"> When pulses were being output or positioning was starting, the PLC decelerated and stopped the pulse output due to the limit of the moving direction or writing during RUN. (The PLSY/DPLSY instruction stops pulse output immediately at both limits.) When pulses were being output or positioning was starting, the PLC decelerated and stopped the pulse output by the pulse decelerate and stop command. When pulses were being output, the command speed was changed to 0. When pulses were being output, RUN→PAUSE/RUN→STOP operation was executed. 	Continue/stop ^{*1}	<ul style="list-style-type: none"> Eliminate the error that has caused the stop and restart the positioning. 	Error location information and system configuration information	At END instruction execution, at instruction execution
3657H	Axis 7 error stop (deceleration stop)	<ul style="list-style-type: none"> When pulses were being output or positioning was starting, the PLC decelerated and stopped the pulse output due to the limit of the moving direction or writing during RUN. (The PLSY/DPLSY instruction stops pulse output immediately at both limits.) When pulses were being output or positioning was starting, the PLC decelerated and stopped the pulse output by the pulse decelerate and stop command. When pulses were being output, the command speed was changed to 0. When pulses were being output, RUN→PAUSE/RUN→STOP operation was executed. 	Continue/stop ^{*1}	<ul style="list-style-type: none"> Eliminate the error that has caused the stop and restart the positioning. 	Error location information and system configuration information	At END instruction execution, at instruction execution
3658H	Axis 8 error stop (deceleration stop)	<ul style="list-style-type: none"> When pulses were being output or positioning was starting, the PLC decelerated and stopped the pulse output due to the limit of the moving direction or writing during RUN. (The PLSY/DPLSY instruction stops pulse output immediately at both limits.) When pulses were being output or positioning was starting, the PLC decelerated and stopped the pulse output by the pulse decelerate and stop command. When pulses were being output, the command speed was changed to 0. When pulses were being output, RUN→PAUSE/RUN→STOP operation was executed. 	Continue/stop ^{*1}	<ul style="list-style-type: none"> Eliminate the error that has caused the stop and restart the positioning. 	Error location information and system configuration information	At END instruction execution, at instruction execution



Error code	Error name	Error details and cause	Stop/continue	Action	Detailed information	Diagnostic timing
3659H	Axis 9 error stop (deceleration stop)	<ul style="list-style-type: none"> When pulses were being output or positioning was starting, the PLC decelerated and stopped the pulse output due to the limit of the moving direction or writing during RUN. (The PLSY/DPLSY instruction stops pulse output immediately at both limits.) When pulses were being output or positioning was starting, the PLC decelerated and stopped the pulse output by the pulse decelerate and stop command. When pulses were being output, the command speed was changed to 0. When pulses were being output, RUN→PAUSE/RUN→STOP operation was executed. 	Continue/stop ^{*1}	<ul style="list-style-type: none"> Eliminate the error that has caused the stop and restart the positioning. 	Error location information and system configuration information	At END instruction execution, at instruction execution
365AH	Axis 10 error stop (deceleration stop)	<ul style="list-style-type: none"> When pulses were being output or positioning was starting, the PLC decelerated and stopped the pulse output due to the limit of the moving direction or writing during RUN. (The PLSY/DPLSY instruction stops pulse output immediately at both limits.) When pulses were being output or positioning was starting, the PLC decelerated and stopped the pulse output by the pulse decelerate and stop command. When pulses were being output, the command speed was changed to 0. When pulses were being output, RUN→PAUSE/RUN→STOP operation was executed. 	Continue/stop ^{*1}	<ul style="list-style-type: none"> Eliminate the error that has caused the stop and restart the positioning. 	Error location information and system configuration information	At END instruction execution, at instruction execution
365BH	Axis 11 error stop (deceleration stop)	<ul style="list-style-type: none"> When pulses were being output or positioning was starting, the PLC decelerated and stopped the pulse output due to the limit of the moving direction or writing during RUN. (The PLSY/DPLSY instruction stops pulse output immediately at both limits.) When pulses were being output or positioning was starting, the PLC decelerated and stopped the pulse output by the pulse decelerate and stop command. When pulses were being output, the command speed was changed to 0. When pulses were being output, RUN→PAUSE/RUN→STOP operation was executed. 	Continue/stop ^{*1}	<ul style="list-style-type: none"> Eliminate the error that has caused the stop and restart the positioning. 	Error location information and system configuration information	At END instruction execution, at instruction execution

Error code	Error name	Error details and cause	Stop/continue	Action	Detailed information	Diagnostic timing
365CH	Axis 12 error stop (deceleration stop)	<ul style="list-style-type: none"> When pulses were being output or positioning was starting, the PLC decelerated and stopped the pulse output due to the limit of the moving direction or writing during RUN. (The PLSY/DPLSY instruction stops pulse output immediately at both limits.) When pulses were being output or positioning was starting, the PLC decelerated and stopped the pulse output by the pulse decelerate and stop command. When pulses were being output, the command speed was changed to 0. When pulses were being output, RUN→PAUSE/RUN→STOP operation was executed. 	Continue/stop ^{*1}	<ul style="list-style-type: none"> Eliminate the error that has caused the stop and restart the positioning. 	Error location information and system configuration information	At END instruction execution, at instruction execution
3661H	Axis 1 error stop (immediately stop)	<ul style="list-style-type: none"> When pulses were being output or positioning was rising, the PLC stopped the pulse output immediately by the pulse stop command or detection of the all outputs disable flag. 	Continue/stop ^{*1}	<ul style="list-style-type: none"> Eliminate the error that has caused the stop and restart the positioning. 	Error location information and system configuration information	At END instruction execution, at instruction execution
3662H	Axis 2 error stop (immediately stop)	<ul style="list-style-type: none"> When pulses were being output or positioning was rising, the PLC stopped the pulse output immediately by the pulse stop command or detection of the all outputs disable flag. 	Continue/stop ^{*1}	<ul style="list-style-type: none"> Eliminate the error that has caused the stop and restart the positioning. 	Error location information and system configuration information	At END instruction execution, at instruction execution
3663H	Axis 3 error stop (immediately stop)	<ul style="list-style-type: none"> When pulses were being output or positioning was rising, the PLC stopped the pulse output immediately by the pulse stop command or detection of the all outputs disable flag. 	Continue/stop ^{*1}	<ul style="list-style-type: none"> Eliminate the error that has caused the stop and restart the positioning. 	Error location information and system configuration information	At END instruction execution, at instruction execution
3664H	Axis 4 error stop (immediately stop)	<ul style="list-style-type: none"> When pulses were being output or positioning was rising, the PLC stopped the pulse output immediately by the pulse stop command or detection of the all outputs disable flag. 	Continue/stop ^{*1}	<ul style="list-style-type: none"> Eliminate the error that has caused the stop and restart the positioning. 	Error location information and system configuration information	At END instruction execution, at instruction execution
3665H	Axis 5 error stop (immediately stop)	<ul style="list-style-type: none"> When pulses were being output or positioning was rising, the PLC stopped the pulse output immediately by the pulse stop command or detection of the all outputs disable flag. 	Continue/stop ^{*1}	<ul style="list-style-type: none"> Eliminate the error that has caused the stop and restart the positioning. 	Error location information and system configuration information	At END instruction execution, at instruction execution
3666H	Axis 6 error stop (immediately stop)	<ul style="list-style-type: none"> When pulses were being output or positioning was rising, the PLC stopped the pulse output immediately by the pulse stop command or detection of the all outputs disable flag. 	Continue/stop ^{*1}	<ul style="list-style-type: none"> Eliminate the error that has caused the stop and restart the positioning. 	Error location information and system configuration information	At END instruction execution, at instruction execution
3667H	Axis 7 error stop (immediately stop)	<ul style="list-style-type: none"> When pulses were being output or positioning was rising, the PLC stopped the pulse output immediately by the pulse stop command or detection of the all outputs disable flag. 	Continue/stop ^{*1}	<ul style="list-style-type: none"> Eliminate the error that has caused the stop and restart the positioning. 	Error location information and system configuration information	At END instruction execution, at instruction execution
3668H	Axis 8 error stop (immediately stop)	<ul style="list-style-type: none"> When pulses were being output or positioning was rising, the PLC stopped the pulse output immediately by the pulse stop command or detection of the all outputs disable flag. 	Continue/stop ^{*1}	<ul style="list-style-type: none"> Eliminate the error that has caused the stop and restart the positioning. 	Error location information and system configuration information	At END instruction execution, at instruction execution



Error code	Error name	Error details and cause	Stop/continue	Action	Detailed information	Diagnostic timing
3669H	Axis 9 error stop (immediately stop)	• When pulses were being output or positioning was rising, the PLC stopped the pulse output immediately by the pulse stop command or detection of the all outputs disable flag.	Continue/stop ^{*1}	• Eliminate the error that has caused the stop and restart the positioning.	Error location information and system configuration information	At END instruction execution, at instruction execution
366AH	Axis 10 error stop (immediately stop)	• When pulses were being output or positioning was rising, the PLC stopped the pulse output immediately by the pulse stop command or detection of the all outputs disable flag.	Continue/stop ^{*1}	• Eliminate the error that has caused the stop and restart the positioning.	Error location information and system configuration information	At END instruction execution, at instruction execution
366BH	Axis 11 error stop (immediately stop)	• When pulses were being output or positioning was rising, the PLC stopped the pulse output immediately by the pulse stop command or detection of the all outputs disable flag.	Continue/stop ^{*1}	• Eliminate the error that has caused the stop and restart the positioning.	Error location information and system configuration information	At END instruction execution, at instruction execution
366CH	Axis 12 error stop (immediately stop)	• When pulses were being output or positioning was rising, the PLC stopped the pulse output immediately by the pulse stop command or detection of the all outputs disable flag.	Continue/stop ^{*1}	• Eliminate the error that has caused the stop and restart the positioning.	Error location information and system configuration information	At END instruction execution, at instruction execution
3671H	Axis 1 positioning table operand error	• The value of an operand in the table is abnormal. (Other than the positioning address and command speed)	Continue/stop ^{*1}	• Set the correct value to the table.	Error location information and system configuration information	At END instruction execution, at interrupt occurrence
3672H	Axis 2 positioning table operand error	• The value of an operand in the table is abnormal. (Other than the positioning address and command speed)	Continue/stop ^{*1}	• Set the correct value to the table.	Error location information and system configuration information	At END instruction execution, at interrupt occurrence
3673H	Axis 3 positioning table operand error	• The value of an operand in the table is abnormal. (Other than the positioning address and command speed)	Continue/stop ^{*1}	• Set the correct value to the table.	Error location information and system configuration information	At END instruction execution, at interrupt occurrence
3674H	Axis 4 positioning table operand error	• The value of an operand in the table is abnormal. (Other than the positioning address and command speed)	Continue/stop ^{*1}	• Set the correct value to the table.	Error location information and system configuration information	At END instruction execution, at interrupt occurrence
3675H	Axis 5 positioning table operand error	• The value of an operand in the table is abnormal. (Other than the positioning address and command speed)	Continue/stop ^{*1}	• Set the correct value to the table.	Error location information and system configuration information	At END instruction execution, at interrupt occurrence
3676H	Axis 6 positioning table operand error	• The value of an operand in the table is abnormal. (Other than the positioning address and command speed)	Continue/stop ^{*1}	• Set the correct value to the table.	Error location information and system configuration information	At END instruction execution, at interrupt occurrence
3677H	Axis 7 positioning table operand error	• The value of an operand in the table is abnormal. (Other than the positioning address and command speed)	Continue/stop ^{*1}	• Set the correct value to the table.	Error location information and system configuration information	At END instruction execution, at interrupt occurrence
3678H	Axis 8 positioning table operand error	• The value of an operand in the table is abnormal. (Other than the positioning address and command speed)	Continue/stop ^{*1}	• Set the correct value to the table.	Error location information and system configuration information	At END instruction execution, at interrupt occurrence

Error code	Error name	Error details and cause	Stop/continue	Action	Detailed information	Diagnostic timing
3679H	Axis 9 positioning table operand error	<ul style="list-style-type: none"> The value of an operand in the table is abnormal. (Other than the positioning address and command speed) 	Continue/stop ^{*1}	<ul style="list-style-type: none"> Set the correct value to the table. 	Error location information and system configuration information	At END instruction execution, at interrupt occurrence
367AH	Axis 10 positioning table operand error	<ul style="list-style-type: none"> The value of an operand in the table is abnormal. (Other than the positioning address and command speed) 	Continue/stop ^{*1}	<ul style="list-style-type: none"> Set the correct value to the table. 	Error location information and system configuration information	At END instruction execution, at interrupt occurrence
367BH	Axis 11 positioning table operand error	<ul style="list-style-type: none"> The value of an operand in the table is abnormal. (Other than the positioning address and command speed) 	Stop/continue	<ul style="list-style-type: none"> Set the correct value to the table. 	Error location information and system configuration information	At END instruction execution, at interrupt occurrence
367CH	Axis 12 positioning table operand error	<ul style="list-style-type: none"> The value of an operand in the table is abnormal. (Other than the positioning address and command speed) 	Continue/stop ^{*1}	<ul style="list-style-type: none"> Set the correct value to the table. 	Error location information and system configuration information	At END instruction execution, at interrupt occurrence
3681H	Axis 1 positioning table shift error (table specification)	<ul style="list-style-type: none"> Tables which cannot be used together were specified for continuous operation. The counterpart axis for the interpolation operation table was specified. 	Continue/stop ^{*1}	<ul style="list-style-type: none"> Observe the restrictions on table operation. 	Error location information and system configuration information	At END instruction execution, at interrupt occurrence
3682H	Axis 2 positioning table shift error (table specification)	<ul style="list-style-type: none"> Tables which cannot be used together were specified for continuous operation. The counterpart axis for the interpolation operation table was specified. 	Continue/stop ^{*1}	<ul style="list-style-type: none"> Observe the restrictions on table operation. 	Error location information and system configuration information	At END instruction execution, at interrupt occurrence
3683H	Axis 3 positioning table shift error (table specification)	<ul style="list-style-type: none"> Tables which cannot be used together were specified for continuous operation. The counterpart axis for the interpolation operation table was specified. 	Continue/stop ^{*1}	<ul style="list-style-type: none"> Observe the restrictions on table operation. 	Error location information and system configuration information	At END instruction execution, at interrupt occurrence
3684H	Axis 4 positioning table shift error (table specification)	<ul style="list-style-type: none"> Tables which cannot be used together were specified for continuous operation. The counterpart axis for the interpolation operation table was specified. 	Continue/stop ^{*1}	<ul style="list-style-type: none"> Observe the restrictions on table operation. 	Error location information and system configuration information	At END instruction execution, at interrupt occurrence
3685H	Axis 5 positioning table shift error (table specification)	<ul style="list-style-type: none"> Tables which cannot be used together were specified for continuous operation. The counterpart axis for the interpolation operation table was specified. 	Continue/stop ^{*1}	<ul style="list-style-type: none"> Observe the restrictions on table operation. 	Error location information and system configuration information	At END instruction execution, at interrupt occurrence
3686H	Axis 6 positioning table shift error (table specification)	<ul style="list-style-type: none"> Tables which cannot be used together were specified for continuous operation. The counterpart axis for the interpolation operation table was specified. 	Continue/stop ^{*1}	<ul style="list-style-type: none"> Observe the restrictions on table operation. 	Error location information and system configuration information	At END instruction execution, at interrupt occurrence
3687H	Axis 7 positioning table shift error (table specification)	<ul style="list-style-type: none"> Tables which cannot be used together were specified for continuous operation. The counterpart axis for the interpolation operation table was specified. 	Continue/stop ^{*1}	<ul style="list-style-type: none"> Observe the restrictions on table operation. 	Error location information and system configuration information	At END instruction execution, at interrupt occurrence



Error code	Error name	Error details and cause	Stop/continue	Action	Detailed information	Diagnostic timing
3688H	Axis 8 positioning table shift error (table specification)	<ul style="list-style-type: none"> • Tables which cannot be used together were specified for continuous operation. • The counterpart axis for the interpolation operation table was specified. 	Continue/stop ^{*1}	<ul style="list-style-type: none"> • Observe the restrictions on table operation. 	Error location information and system configuration information	At END instruction execution, at interrupt occurrence
3689H	Axis 9 positioning table shift error (table specification)	<ul style="list-style-type: none"> • Tables which cannot be used together were specified for continuous operation. • The counterpart axis for the interpolation operation table was specified. 	Continue/stop ^{*1}	<ul style="list-style-type: none"> • Observe the restrictions on table operation. 	Error location information and system configuration information	At END instruction execution, at interrupt occurrence
368AH	Axis 10 positioning table shift error (table specification)	<ul style="list-style-type: none"> • Tables which cannot be used together were specified for continuous operation. • The counterpart axis for the interpolation operation table was specified. 	Continue/stop ^{*1}	<ul style="list-style-type: none"> • Observe the restrictions on table operation. 	Error location information and system configuration information	At END instruction execution, at interrupt occurrence
368BH	Axis 11 positioning table shift error (table specification)	<ul style="list-style-type: none"> • Tables which cannot be used together were specified for continuous operation. • The counterpart axis for the interpolation operation table was specified. 	Continue/stop ^{*1}	<ul style="list-style-type: none"> • Observe the restrictions on table operation. 	Error location information and system configuration information	At END instruction execution, at interrupt occurrence
368CH	Axis 12 positioning table shift error (table specification)	<ul style="list-style-type: none"> • Tables which cannot be used together were specified for continuous operation. • The counterpart axis for the interpolation operation table was specified. 	Continue/stop ^{*1}	<ul style="list-style-type: none"> • Observe the restrictions on table operation. 	Error location information and system configuration information	At END instruction execution, at interrupt occurrence
3691H	Axis 1 positioning table shift error (table shift)	<ul style="list-style-type: none"> • Table shift cannot be completed in time because one or more tables shifted per 10 ms. • 4 or more tables that need not to be output were continuously specified. • A conditional jump was executed 4 times in a row. 	Continue/stop ^{*1}	<ul style="list-style-type: none"> • Set the interval of table shifts to 10 ms or greater. 	Error location information and system configuration information	At interrupt occurrence
3692H	Axis 2 positioning table shift error (table shift)	<ul style="list-style-type: none"> • Table shift cannot be completed in time because one or more tables shifted per 10 ms. • 4 or more tables that need not to be output were continuously specified. • A conditional jump was executed 4 times in a row. 	Continue/stop ^{*1}	<ul style="list-style-type: none"> • Set the interval of table shifts to 10 ms or greater. 	Error location information and system configuration information	At interrupt occurrence
3693H	Axis 3 positioning table shift error (table shift)	<ul style="list-style-type: none"> • Table shift cannot be completed in time because one or more tables shifted per 10 ms. • 4 or more tables that need not to be output were continuously specified. • A conditional jump was executed 4 times in a row. 	Continue/stop ^{*1}	<ul style="list-style-type: none"> • Set the interval of table shifts to 10 ms or greater. 	Error location information and system configuration information	At interrupt occurrence
3694H	Axis 4 positioning table shift error (table shift)	<ul style="list-style-type: none"> • Table shift cannot be completed in time because one or more tables shifted per 10 ms. • 4 or more tables that need not to be output were continuously specified. • A conditional jump was executed 4 times in a row. 	Continue/stop ^{*1}	<ul style="list-style-type: none"> • Set the interval of table shifts to 10 ms or greater. 	Error location information and system configuration information	At interrupt occurrence

Error code	Error name	Error details and cause	Stop/continue	Action	Detailed information	Diagnostic timing
3695H	Axis 5 positioning table shift error (table shift)	<ul style="list-style-type: none"> • Table shift cannot be completed in time because one or more tables shifted per 10 ms. • 4 or more tables that need not to be output were continuously specified. • A conditional jump was executed 4 times in a row. 	Continue/stop ^{*1}	<ul style="list-style-type: none"> • Set the interval of table shifts to 10 ms or greater. 	Error location information and system configuration information	At interrupt occurrence
3696H	Axis 6 positioning table shift error (table shift)	<ul style="list-style-type: none"> • Table shift cannot be completed in time because one or more tables shifted per 10 ms. • 4 or more tables that need not to be output were continuously specified. • A conditional jump was executed 4 times in a row. 	Continue/stop ^{*1}	<ul style="list-style-type: none"> • Set the interval of table shifts to 10 ms or greater. 	Error location information and system configuration information	At interrupt occurrence
3697H	Axis 7 positioning table shift error (table shift)	<ul style="list-style-type: none"> • Table shift cannot be completed in time because one or more tables shifted per 10 ms. • 4 or more tables that need not to be output were continuously specified. • A conditional jump was executed 4 times in a row. 	Continue/stop ^{*1}	<ul style="list-style-type: none"> • Set the interval of table shifts to 10 ms or greater. 	Error location information and system configuration information	At interrupt occurrence
3698H	Axis 8 positioning table shift error (table shift)	<ul style="list-style-type: none"> • Table shift cannot be completed in time because one or more tables shifted per 10 ms. • 4 or more tables that need not to be output were continuously specified. • A conditional jump was executed 4 times in a row. 	Continue/stop ^{*1}	<ul style="list-style-type: none"> • Set the interval of table shifts to 10 ms or greater. 	Error location information and system configuration information	At interrupt occurrence
3699H	Axis 9 positioning table shift error (table shift)	<ul style="list-style-type: none"> • Table shift cannot be completed in time because one or more tables shifted per 10 ms. • 4 or more tables that need not to be output were continuously specified. • A conditional jump was executed 4 times in a row. 	Continue/stop ^{*1}	<ul style="list-style-type: none"> • Set the interval of table shifts to 10 ms or greater. 	Error location information and system configuration information	At interrupt occurrence
369AH	Axis 10 positioning table shift error (table shift)	<ul style="list-style-type: none"> • Table shift cannot be completed in time because one or more tables shifted per 10 ms. • 4 or more tables that need not to be output were continuously specified. • A conditional jump was executed 4 times in a row. 	Continue/stop ^{*1}	<ul style="list-style-type: none"> • Set the interval of table shifts to 10 ms or greater. 	Error location information and system configuration information	At interrupt occurrence
369BH	Axis 11 positioning table shift error (table shift)	<ul style="list-style-type: none"> • Table shift cannot be completed in time because one or more tables shifted per 10 ms. • 4 or more tables that need not to be output were continuously specified. • A conditional jump was executed 4 times in a row. 	Continue/stop ^{*1}	<ul style="list-style-type: none"> • Set the interval of table shifts to 10 ms or greater. 	Error location information and system configuration information	At interrupt occurrence
369CH	Axis 12 positioning table shift error (table shift)	<ul style="list-style-type: none"> • Table shift cannot be completed in time because one or more tables shifted per 10 ms. • 4 or more tables that need not to be output were continuously specified. • A conditional jump was executed 4 times in a row. 	Continue/stop ^{*1}	<ul style="list-style-type: none"> • Set the interval of table shifts to 10 ms or greater. 	Error location information and system configuration information	At interrupt occurrence



Error code	Error name	Error details and cause	Stop/continue	Action	Detailed information	Diagnostic timing
36A1H	Axis 1 interpolation operation error (no counterpart axis)	<ul style="list-style-type: none"> The counterpart axis table for the interpolation operation cannot be found. 	Continue/stop ^{*1}	<ul style="list-style-type: none"> Set the table of the counterpart axis correctly. 	Error location information and system configuration information	At instruction execution
36A2H	Axis 2 interpolation operation error (no counterpart axis)	<ul style="list-style-type: none"> The counterpart axis table for the interpolation operation cannot be found. 	Continue/stop ^{*1}	<ul style="list-style-type: none"> Set the table of the counterpart axis correctly. 	Error location information and system configuration information	At instruction execution
36A3H	Axis 3 interpolation operation error (no counterpart axis)	<ul style="list-style-type: none"> The counterpart axis table for the interpolation operation cannot be found. 	Continue/stop ^{*1}	<ul style="list-style-type: none"> Set the table of the counterpart axis correctly. 	Error location information and system configuration information	At instruction execution
36A4H	Axis 4 interpolation operation error (no counterpart axis)	<ul style="list-style-type: none"> The counterpart axis table for the interpolation operation cannot be found. 	Continue/stop ^{*1}	<ul style="list-style-type: none"> Set the table of the counterpart axis correctly. 	Error location information and system configuration information	At instruction execution
36A5H	Axis 5 interpolation operation error (no counterpart axis)	<ul style="list-style-type: none"> The counterpart axis table for the interpolation operation cannot be found. 	Continue/stop ^{*1}	<ul style="list-style-type: none"> Set the table of the counterpart axis correctly. 	Error location information and system configuration information	At instruction execution
36A6H	Axis 6 interpolation operation error (no counterpart axis)	<ul style="list-style-type: none"> The counterpart axis table for the interpolation operation cannot be found. 	Continue/stop ^{*1}	<ul style="list-style-type: none"> Set the table of the counterpart axis correctly. 	Error location information and system configuration information	At instruction execution
36A7H	Axis 7 interpolation operation error (no counterpart axis)	<ul style="list-style-type: none"> The counterpart axis table for the interpolation operation cannot be found. 	Continue/stop ^{*1}	<ul style="list-style-type: none"> Set the table of the counterpart axis correctly. 	Error location information and system configuration information	At instruction execution
36A8H	Axis 8 interpolation operation error (no counterpart axis)	<ul style="list-style-type: none"> The counterpart axis table for the interpolation operation cannot be found. 	Continue/stop ^{*1}	<ul style="list-style-type: none"> Set the table of the counterpart axis correctly. 	Error location information and system configuration information	At instruction execution
36A9H	Axis 9 interpolation operation error (no counterpart axis)	<ul style="list-style-type: none"> The counterpart axis table for the interpolation operation cannot be found. 	Continue/stop ^{*1}	<ul style="list-style-type: none"> Set the table of the counterpart axis correctly. 	Error location information and system configuration information	At instruction execution
36AAH	Axis 10 interpolation operation error (no counterpart axis)	<ul style="list-style-type: none"> The counterpart axis table for the interpolation operation cannot be found. 	Continue/stop ^{*1}	<ul style="list-style-type: none"> Set the table of the counterpart axis correctly. 	Error location information and system configuration information	At instruction execution
36ABH	Axis 11 interpolation operation error (no counterpart axis)	<ul style="list-style-type: none"> The counterpart axis table for the interpolation operation cannot be found. 	Continue/stop ^{*1}	<ul style="list-style-type: none"> Set the table of the counterpart axis correctly. 	Error location information and system configuration information	At instruction execution
36ACH	Axis 12 interpolation operation error (no counterpart axis)	<ul style="list-style-type: none"> The counterpart axis table for the interpolation operation cannot be found. 	Continue/stop ^{*1}	<ul style="list-style-type: none"> Set the table of the counterpart axis correctly. 	Error location information and system configuration information	At instruction execution
36B1H	Axis 1 interpolation operation error (reference/counterpart axis error)	<ul style="list-style-type: none"> Conditions such as limits were satisfied to stop pulses in the reference axis or counterpart axis. Pulses are being output. 	Continue/stop ^{*1}	<ul style="list-style-type: none"> Verify that the reference axis and counterpart axis are not in use and the stop conditions are not satisfied. 	Error location information and system configuration information	At instruction execution

Error code	Error name	Error details and cause	Stop/continue	Action	Detailed information	Diagnostic timing
36F0H	ABS sum error	• There is a sum check error in ABS data read from servo.	Continue/stop ^{*1}	• Check servo wiring and setting.	Error location information and system configuration information	At instruction execution
3780H	High-speed comparison table maximum excess error	• The number of high-speed comparison tables registered is greater than the upper limit.	Continue/stop ^{*1}	• Check the total number of tables in the parameters and tables registered in the comparison match instruction.	Error location information	At END instruction execution, at instruction execution
3781H	Preset value range outside error	• The preset value is greater than the ring length set value.	Continue/stop ^{*1}	• Disable the ring length. • Set the preset value within the ring length range.	Error location information and system configuration information	At instruction execution
3A00H	Incompatible function in use error	• A CPU module with a serial No. incompatible with the function was used.	Stop	• Use a CPU module with a serial No. compatible with the function. (Refer to  Page 566 Added and Enhanced Functions.)	Parameter information	At power-on, at function use
3C00H	Hardware failure	• A hardware failure was detected.	Stop	• Reset the CPU module and perform RUN. If the same error appears, the hardware of the CPU module may be malfunctioning. Consult your local Mitsubishi Electric representative.	System configuration information	At power-on, at RESET
3C02H	Hardware failure	• A hardware failure was detected.	Stop	• Reset the CPU module and perform RUN. If the same error appears, the hardware of the CPU module may be malfunctioning. Consult your local Mitsubishi Electric representative.	System configuration information	At power-on, at RESET
3C03H	Hardware failure	• A hardware failure was detected.	Stop	• Reset the CPU module and perform RUN. If the same error appears, the hardware of the CPU module may be malfunctioning. Consult your local Mitsubishi Electric representative.	—	At power-on, at RESET
3C0FH	Hardware failure	• A hardware failure was detected.	Stop	• When an intelligent function module is connected to a CPU module, check that the firmware version of the CPU module is compatible with the intelligent function module, and if not compatible, execute the firmware update. • Reset the CPU module and perform RUN. If the same error appears, the hardware of the CPU module may be malfunctioning. Consult your local Mitsubishi Electric representative.	—	At power-on, at RESET
3C20H	Memory error	• A memory error was detected.	Stop	• Reset the CPU module and perform RUN. If the same error appears, the hardware of the CPU module may be malfunctioning. Initialize the memory, and if the memory still cannot be recovered, consult your local Mitsubishi Electric representative.	—	At power-on, at RESET
3C22H	Memory error	• A memory error was detected.	Stop	• Reset the CPU module and perform RUN. If the same error appears, the hardware of the CPU module may be malfunctioning. Consult your local Mitsubishi Electric representative.	—	At power-on, at RESET
3C2FH	Memory error	• A memory error was detected.	Stop	• Reset the CPU module and perform RUN. If the same error appears, the hardware of the CPU module may be malfunctioning. Consult your local Mitsubishi Electric representative.	—	At power-on, at RESET

Error code	Error name	Error details and cause	Stop/continue	Action	Detailed information	Diagnostic timing
3C32H	Memory error	<ul style="list-style-type: none"> An error has been detected in the memory. 	Stop	<ul style="list-style-type: none"> Reset the CPU module, and run it again. If the same error code is displayed again, possible cause is hardware failure of the CPU module. Please consult your local Mitsubishi representative. 	—	At power-on, at RESET
3E20H	Program execution error	<ul style="list-style-type: none"> An error has been detected in the memory. 	Stop	<ul style="list-style-type: none"> Reduce the number of steps in the program. 	—	At power-on, at RESET, at STOP → RUN state

*1 Can be changed by the parameter. (Default: Continue)

*2 Can be changed by the parameter. (Default: Stop)

*3 If the error is detected at startup, the operation stops regardless of the parameter setting.

Error codes of the CPU module (4000H to 4FFFH)

The following table lists the error codes detected by other causes than the self-diagnostics function of the CPU module.

Error code	Error name	Error details and cause	Action
4000H	Common error	<ul style="list-style-type: none"> Serial communication sum check error. 	<ul style="list-style-type: none"> Connect the serial communication cable correctly. Take measures to reduce noise.
4001H	Common error	<ul style="list-style-type: none"> An unsupported request was executed. 	<ul style="list-style-type: none"> Check the command data of SLMP/MC protocol. Check the CPU module model name selected in the engineering tool. Check the target CPU module model name.
4002H	Common error	<ul style="list-style-type: none"> An unsupported request was executed. 	<ul style="list-style-type: none"> Check the command data of SLMP/MC protocol. Check the CPU module model name selected in the engineering tool. Use a CPU module with a serial No. compatible with the function. For details, refer to the manual. Execute the request again. If the same error code is displayed again, the possible cause is a hardware failure of the CPU module. Please consult your local Mitsubishi representative.
4005H	Common error	<ul style="list-style-type: none"> The volume of data handled according to the specified request is too large. 	<ul style="list-style-type: none"> Check the command data of SLMP/MC protocol.
4006H	Common error	<ul style="list-style-type: none"> Initial communication has failed. 	<ul style="list-style-type: none"> When using serial communication, check with the external device manufacturer for support conditions. When using serial communication, check the CPU module model name selected in the engineering tool. When using Ethernet communication, shift the communication start timing.
4010H	CPU module operation error	<ul style="list-style-type: none"> Since the CPU module is running, the request contents cannot be executed. 	<ul style="list-style-type: none"> Execute after setting the CPU module to STOP status.
4013H	CPU module operation error	<ul style="list-style-type: none"> Since the CPU module is not in a STOP status, the request contents cannot be executed. 	<ul style="list-style-type: none"> Execute after setting the CPU module to STOP status.
4021H	File related error	<ul style="list-style-type: none"> The specified drive (memory) does not exist or there is an error. 	<ul style="list-style-type: none"> Check the specified drive (memory) status. Back up data in the CPU module, and then initialize the memory.
4022H	File related error	<ul style="list-style-type: none"> The file with the specified file name or file No. does not exist. 	<ul style="list-style-type: none"> Check the specified file name and file No.
4025H	File related error	<ul style="list-style-type: none"> The specified file is processing the request from another engineering tool. 	<ul style="list-style-type: none"> Forcibly execute the request. Or, execute the request again after the processing being performed ends.
4027H	File related error	<ul style="list-style-type: none"> The specified range is larger than the file size. 	<ul style="list-style-type: none"> Check the specified range and access within that range.
4029H	File related error	<ul style="list-style-type: none"> The specified file capacity cannot be obtained. 	<ul style="list-style-type: none"> Review the specified file capacity, and execute the request again.
402CH	File related error	<ul style="list-style-type: none"> The requested operation cannot be executed currently. 	<ul style="list-style-type: none"> Execute again after a while.
4030H	Device specification error	<ul style="list-style-type: none"> The specified device name cannot be handled. ■When CPU Module Logging Configuration Tool is used The data logging specifying a device that is not supported was started. 	<ul style="list-style-type: none"> Check the specified device name.
4031H	Device specification error	<ul style="list-style-type: none"> The specified device No. is outside the range. The CPU module cannot handle the specified device. ■When CPU Module Logging Configuration Tool is used The data logging specifying a device number that does not exist was started. 	<ul style="list-style-type: none"> Check the specified device No. Check the device assignment of the CPU module. Check the specified device name.
4032H	Device specification error	<ul style="list-style-type: none"> The device modification was incorrectly specified. Or, the unusable device (TS, TC, SS, SC, CS, or CC) was specified in any of the following SLMP/MC protocol commands; Read random, Write random (in units of words), Entry monitor device, or Execute monitor. ■When CPU Module Logging Configuration Tool is used The data logging specifying a device modification that is not supported was started. 	<ul style="list-style-type: none"> Check the device modification method. Check the specified device name.
4034H	Device specification error	<ul style="list-style-type: none"> The dedicated instruction cannot be executed since the completion device for the dedicated instruction does not turn on. 	<ul style="list-style-type: none"> Since the completion device for the SREAD or SWRITE instruction does not turn on in the CPU module on the target station, execute the instruction again after setting the operating status of the CPU module on the target station to the RUN status.

Error code	Error name	Error details and cause	Action
4040H	Intelligent function module specification error	<ul style="list-style-type: none"> The request contents cannot be executed in the specified intelligent function module. 	<ul style="list-style-type: none"> Check whether the specified module is the intelligent function module having the buffer memory.
4041H	Intelligent function module specification error	<ul style="list-style-type: none"> The access range exceeds the buffer memory range of the specified intelligent function module. 	<ul style="list-style-type: none"> Check the start address and access number of points and access within the range that exists in the intelligent function module.
4042H	Intelligent function module specification error	<ul style="list-style-type: none"> The specified intelligent function module cannot be accessed. 	<ul style="list-style-type: none"> Check that the specified intelligent function module is operating normally. Check the specified module for a hardware fault.
4043H	Intelligent function module specification error	<ul style="list-style-type: none"> The intelligent function module does not exist in the specified position. ■When CPU Module Logging Configuration Tool is used The data logging specifying a device that does not exist or cannot be accessed was started. 	<ul style="list-style-type: none"> Check the I/O number of the specified intelligent function module.
4053H	Protect error	<ul style="list-style-type: none"> An error occurred when writing data to the specified drive (memory). 	<ul style="list-style-type: none"> Check the specified drive (memory). Or, write data again after changing the corresponding drive (memory).
4060H	Online registration error	<ul style="list-style-type: none"> The online debug function and the data logging function are being executed with another engineering tool. ■When CPU Module Logging Configuration Tool is used An attempt was made to write or delete data logging settings or to execute data logging to the setting registered by another request source. 	<ul style="list-style-type: none"> Finish the operation of the other engineering tool and then execute the function again. If the operation of the other engineering tool is on hold, resume and finish the operation of the other engineering tool, and then execute the function again.
4064H	Online registration error	<ul style="list-style-type: none"> The specified content of the data logging function, memory dump function and real-time monitor function is incorrect. ■When CPU Module Logging Configuration Tool is used The trigger logging was started in a state that the trigger condition has already been satisfied. The logging was started in a state that the condition of the file switching timing condition specification has already been satisfied. 	<ul style="list-style-type: none"> Check the set data of the data logging function, memory dump function and real-time monitor function. Execute again after checking the communication route such as the communication cable. ■When CPU Module Logging Configuration Tool is used Clear the satisfied trigger condition, and execute the trigger logging again. Clear the satisfied condition of the file switching timing condition specification, and execute the logging again.
4068H	Online registration error	<ul style="list-style-type: none"> Operation is disabled because it is being performed with another engineering tool. 	<ul style="list-style-type: none"> Execute the request again after processing of the function executed from the other engineering tool ends.
4080H	Other errors	<ul style="list-style-type: none"> Request data error. ■When CPU Module Logging Configuration Tool is used Request or setting data error 	<ul style="list-style-type: none"> Check the request data that has been specified. ■When CPU Module Logging Configuration Tool is used Check the specified data, and write it to the CPU module again.
4081H	Other errors	<ul style="list-style-type: none"> The search target data cannot be detected. 	<ul style="list-style-type: none"> Check the data to be searched.
408BH	Other errors	<ul style="list-style-type: none"> The remote request cannot be executed. 	<ul style="list-style-type: none"> Reexecute after the CPU module is in a status where the remote request can be executed. For remote operation, set the parameter to "Enable remote reset".
4105H	Any other error	<ul style="list-style-type: none"> Hardware failure of the CPU module internal memory. 	<ul style="list-style-type: none"> The possible cause is a hardware failure of the CPU module. Please consult your local Mitsubishi representative.
4121H	File related error	<ul style="list-style-type: none"> The specified drive (memory) or file does not exist. 	<ul style="list-style-type: none"> Execute again after checking the specified drive (memory) or file.
4122H	File related error	<ul style="list-style-type: none"> The specified drive (memory) or file does not exist. 	<ul style="list-style-type: none"> Execute again after checking the specified drive (memory) or file.
4123H	File related error	<ul style="list-style-type: none"> The specified drive (memory) is abnormal. ■When CPU Module Logging Configuration Tool is used The data logging was started to the memory having an error. 	<ul style="list-style-type: none"> Initialize the memory, and restore the drive (memory) to its normal state.
4125H	File related error	<ul style="list-style-type: none"> The specified drive (memory) or file is performing processing. 	<ul style="list-style-type: none"> Execute again after a while.
4126H	File related error	<ul style="list-style-type: none"> The specified drive (memory) or file is performing processing. 	<ul style="list-style-type: none"> Execute again after a while.
4127H	File related error	<ul style="list-style-type: none"> File password mismatch. 	<ul style="list-style-type: none"> Execute again after checking the file password.
4135H	File related error	<ul style="list-style-type: none"> The date/time data of the engineering tool (personal computer) is out of range. 	<ul style="list-style-type: none"> Execute again after checking the clock setting of the engineering tool (personal computer).
4136H	File related error	<ul style="list-style-type: none"> The specified file already exists. 	<ul style="list-style-type: none"> Execute again after checking the specified file name.

Error code	Error name	Error details and cause	Action
4139H	File related error	<ul style="list-style-type: none"> The size of the specified file has exceeded that of the existing file. 	<ul style="list-style-type: none"> Execute again after checking the size of the specified file.
413AH	File related error	<ul style="list-style-type: none"> The specified file has exceeded the already existing file size. 	<ul style="list-style-type: none"> Execute again after checking the size of the specified file.
413BH	File related error	<ul style="list-style-type: none"> The same file was simultaneously accessed from different engineering tools. ■When CPU Module Logging Configuration Tool is used An operation was performed to a file being accessed. 	<ul style="list-style-type: none"> Execute again after a while.
413EH	File related error	<ul style="list-style-type: none"> Operation is disabled for the specified drive (memory). 	<ul style="list-style-type: none"> Execute again after changing the target drive (memory).
4180H	CPU module built-in Ethernet port error	<ul style="list-style-type: none"> A system error or setting data error in the OS (Malfunctions caused by noise and hardware failure are possible causes.) 	<ul style="list-style-type: none"> Confirm that the power supply module and CPU module is mounted correctly. Confirm that the usage environment of the system is in the ranges of the generic specifications for the CPU module. Confirm that the power supply capacity is enough. Reset the CPU module. If the same error appears, the hardware of the CPU module may be malfunctioning. Consult your local Mitsubishi Electric representative. If an error occurs again after the above confirmation and corrective actions, hardware failure of the CPU module is a possible cause.
4181H	CPU module built-in Ethernet port error	<ul style="list-style-type: none"> Transmission to the receiving modules is unsuccessful. 	<ul style="list-style-type: none"> Check the external device operation. Check the status of the lines, such as cables, hubs and routes, connected to receiving modules. Some line packets may be engaged. Retry to communicate a little while later. The receiving module may have no free space in receive area (TCP window size is small). Check whether the receiving module processes receive data, or whether the CPU module does not send unnecessary data. Check whether the settings of the subnet mask pattern and the default router IP address of the CPU module and the receiving modules are correct, or whether the class of the IP address is correct.
4183H	CPU module built-in Ethernet port error	<ul style="list-style-type: none"> Communication with receiving modules was interrupted. 	<ul style="list-style-type: none"> Check the external device operation. Check the status of the lines such as cables, hubs and routes connected to receiving modules. Error may be generated when connection is forcibly canceled during communication. In that case, there is no issue, so clear the error.
419AH	CPU module built-in Ethernet port error	<ul style="list-style-type: none"> A system error or setting data error in the OS (Malfunctions caused by noise and others and hardware failure are the possible causes.) 	<ul style="list-style-type: none"> Check the external device operation. Check the status of the lines such as cables, hubs and routes connected to receiving modules. The error may be generated when connection is forcibly canceled during communication. In that case, there is no issue, so clear the error.
419EH	CPU module built-in Ethernet port error	<ul style="list-style-type: none"> Connection to the module was unsuccessful or interrupted. 	<ul style="list-style-type: none"> Check the external device operation. Check the status of the lines such as cables, hubs and routes connected to receiving modules. Retry to connect a little while later, if the error occurred in communication.
41C5H	File related error	<ul style="list-style-type: none"> The specified file does not exist. ■When CPU Module Logging Configuration Tool is used When an attempt was made to re-register the data logging with the previous settings, the corresponding file did not exist. 	<ul style="list-style-type: none"> Execute again after checking the file.
41C8H	File related error	<ul style="list-style-type: none"> The size of the specified file has exceeded that of the existing file. 	<ul style="list-style-type: none"> Execute again after checking the size of the specified file. If the error recurs after re-execution, the file information data may be corrupted. Back up data in the CPU module, and then initialize the memory.

Error code	Error name	Error details and cause	Action
41CCH	File related error	<ul style="list-style-type: none"> The specified file does not exist. Or, the specified subdirectory does not exist. ■When CPU Module Logging Configuration Tool is used The data logging was started in a state that sub-folders for storing data logging files (or folders) cannot be created or accessed. Or, sub-folders cannot be created or accessed while the data logging is being performed or the logged data is being saved. 	<ul style="list-style-type: none"> Execute again after checking the name of the file and subdirectory.
41CDH	File related error	<ul style="list-style-type: none"> An access to the file is prohibited in the system. ■When CPU Module Logging Configuration Tool is used The data logging was started in a state that files (or folders) cannot be created or accessed because a file (or folder) with the same name exists. Or, files (folders) cannot be created or accessed while the data logging is being performed or the logged data is being saved. 	<ul style="list-style-type: none"> Do not access the specified file or subdirectory. Execute again after checking the file and subdirectory.
41D0H	File related error	<ul style="list-style-type: none"> The specified drive (memory) has no free space. Or, the number of files in the directory of the specified drive (memory) has exceeded the maximum. 	<ul style="list-style-type: none"> Execute again after increasing the free space of the drive (memory). Delete files in the drive (memory), and execute the function again.
41D8H	File related error	<ul style="list-style-type: none"> The specified file is being accessed. 	<ul style="list-style-type: none"> Execute again after a while.
41DFH	File related error	<ul style="list-style-type: none"> The specified drive (memory) is write-protected. 	<ul style="list-style-type: none"> Execute again after canceling the write protect of the specified drive (memory).
41E4H	File related error	<ul style="list-style-type: none"> Access to the SD memory card has failed. 	<ul style="list-style-type: none"> Execute the operation again after checking that the SD memory card has been inserted. Execute the operation again after replacing the SD memory card. Back up data, and then initialize the memory.
41EBH	File related error	<ul style="list-style-type: none"> The file name path is too long. 	<ul style="list-style-type: none"> Execute again after shortening the file name path.
41FBH	File related error	<ul style="list-style-type: none"> The specified file is already being processed by the engineering tool. 	<ul style="list-style-type: none"> Execute again after the currently performed operation is completed.
41FEH	File related error	<ul style="list-style-type: none"> The SD memory card has not been inserted. The SD memory card is disabled. The SD memory card is disabled by SM606 (SD memory card forced disable instruction). ■When CPU Module Logging Configuration Tool is used The data logging was started when the CPU module is in the following state: no SD memory card is inserted; the CARD LED is not on; or the SD memory card is forcibly disabled. 	<ul style="list-style-type: none"> Insert the SD memory card. Remove the SD memory card, and insert it again. Cancel the SD memory card forced disable instruction.
4269H	Any other error	<ul style="list-style-type: none"> The remote RUN (function) cannot be executed. 	<ul style="list-style-type: none"> Execute the function again after a while.
4270H	Data logging function error	<ul style="list-style-type: none"> Data logging is being performed (data logging status: RUN waiting (no collection), Start waiting (no collection), Condition waiting (no collection), Pause, Collecting, Trigger waiting (collecting before trigger), Collecting after trigger, or Saving the logging data) to another memory. 	<ul style="list-style-type: none"> Register data logging to the memory where the data logging is being performed. Or, stop the data logging being performed and register again. ■When CPU Module Logging Configuration Tool is used Start the data logging to the memory where the data logging is being performed. Or, stop the data logging being performed, and start the data logging.
4271H	Data logging function error	<ul style="list-style-type: none"> The specified data logging is already being performed (data logging status: RUN waiting (no collection), Start waiting (no collection), Condition waiting (no collection), Pause, Collecting, Trigger waiting (collecting before trigger), Collecting after trigger, or Saving the logging data). 	<ul style="list-style-type: none"> Stop the data logging. Or, write, delete, or register data logging to the setting number where no data logging is being performed.
4276H	Data logging function error	<ul style="list-style-type: none"> The function that cannot be executed during the data logging (data logging status: RUN waiting (no collection), Start waiting (no collection), Condition waiting (no collection), Pause, Collecting, Trigger waiting (collecting before trigger), Collecting after trigger, or Saving the logging data) was executed. 	<ul style="list-style-type: none"> Stop the data logging, and then execute the function.



Error code	Error name	Error details and cause	Action
4277H	Data logging function error	<ul style="list-style-type: none"> The number of saved files exceeded the specified number. ■When CPU Module Logging Configuration Tool is used The data logging was started in a state where the number of saved files has exceeded the specified number. (The operation when the number of saved files exceeded is set to "Stop".) Or, the data logging was started in a state where the number of saved files has exceeded the specified number. (The operation when the number of saved files exceeded is set to "Overwrite".) 	<ul style="list-style-type: none"> The number of files saved in the storage destination memory has exceeded the setting value. Delete files, or change the storage destination and then register. ■When CPU Module Logging Configuration Tool is used The number of files saved in the storage destination memory has exceeded the setting value. Delete files or change the storage destination, and then start the data logging.
4278H	Data logging function error	<ul style="list-style-type: none"> An attempt was made to register data logging in a state where the saved file number has reached its maximum, FFFFFFFF. Or, the number reached to the maximum during the execution. ■When CPU Module Logging Configuration Tool is used The data logging was started in a state where the saved file number has reached its maximum, FFFFFFFF. Or, the number reached to the maximum during the execution. 	<ul style="list-style-type: none"> The saved file number in the storage target memory has reached its maximum, FFFFFFFF. Delete files, or change the storage destination and then register. ■When CPU Module Logging Configuration Tool is used The saved file number in the storage target memory has reached its maximum, FFFFFFFF. Delete files or change the storage target memory, and then perform the data logging.
4279H	Data logging function error	<ul style="list-style-type: none"> An attempt was made to register data logging in a state where the number of saved files is more than the preset number. 	<ul style="list-style-type: none"> The number of saved files has exceeded the preset number of saved files in the storage memory for a result of data logging. Delete some of the saved files or change file storage destinations before continuing the registration.
427BH	Data logging function error	<ul style="list-style-type: none"> The data logging with the same file storage destination is being performed (data logging status: RUN waiting (no collection), Start waiting (no collection), Condition waiting (no collection), Pause, Collecting, Trigger waiting (collecting before trigger), Collecting after trigger, or Saving the logging data). ■When CPU Module Logging Configuration Tool is used The data logging with the same file storage destination is being performed (data logging status: RUN waiting (no collection), Start waiting (no collection), Condition waiting (no collection), Pause, Collecting, Trigger waiting (collecting before trigger), Collecting after trigger, or Saving the logging data). 	<ul style="list-style-type: none"> Stop the data logging destined for the same storage, and then register. Or, change the storage destination of the file, and then register. ■When CPU Module Logging Configuration Tool is used Stop the data logging destined for the same storage, and then perform another data logging. Or, change the storage destination of the file, and then register.
4281H	Data logging function error	<ul style="list-style-type: none"> An attempt was made to register the logging setting for a different PC series. 	<ul style="list-style-type: none"> Register the logging setting for the same PC series.
4282H	Data logging function error	<ul style="list-style-type: none"> The registration was performed with the internal buffer capacity set to 0. 	<ul style="list-style-type: none"> Check and correct the internal buffer capacity setting.
4283H	Data logging function error	<ul style="list-style-type: none"> An attempt was made to register trigger logging in a state that the specified number of records before trigger has exceeded the number of records that can be collected within the internal buffer capacity 	<ul style="list-style-type: none"> Check and correct the internal buffer capacity setting. Reduce the number of records before trigger.
4285H	Data logging function error	<ul style="list-style-type: none"> A non-executable function has been executed during collection or save in memory dump. 	<ul style="list-style-type: none"> Execute the function again after the completion of save in memory dump.
4292H	Debug related function error	<ul style="list-style-type: none"> Real-time monitor does not begin during the execution of real-time monitor. 	<ul style="list-style-type: none"> Start real-time monitor after the stopping of the real-time monitor is being executed.
4293H	Debug related function error	<ul style="list-style-type: none"> Execution fails because the internal buffer exceeds its maximum capacity. 	<ul style="list-style-type: none"> Check and correct the settings of internal buffer capacity, and then try again.
4294H	Debug related function error	<ul style="list-style-type: none"> Execution fails because the settings of internal buffer capacity has been changed during the execution of functions that consume the internal buffer. 	<ul style="list-style-type: none"> Deactivate the functions that consume the internal buffer, and then try again.
433CH	Maintenance and inspection error	<ul style="list-style-type: none"> The error was not cleared. (Error clear was performed during execution of error clear.) 	<ul style="list-style-type: none"> Execute again after a while. If the same error code is displayed again, the possible cause is a hardware failure of the target module. Please consult your local Mitsubishi representative.
4401H	Security function error	<ul style="list-style-type: none"> Read password authentication has failed when required. The file password format is incorrect. 	<ul style="list-style-type: none"> Set the correct read password and perform password authentication. Access the file with the correct method.
4402H	Security function error	<ul style="list-style-type: none"> Write password authentication has failed when required. The file password format is incorrect. 	<ul style="list-style-type: none"> Set the correct write password and perform password authentication. Access the file with the correct method.
4403H	Security function error	<ul style="list-style-type: none"> Both passwords for reading and for writing do not match the previous passwords when trying to change, authenticate, or delete password. 	<ul style="list-style-type: none"> Set correct passwords for both reading and writing, and perform password authentication.
4408H	Security function error	<ul style="list-style-type: none"> File password authentication has failed when required. 	<ul style="list-style-type: none"> Set the correct password and perform password authentication again.

Error code	Error name	Error details and cause	Action
440DH	Security function error	<ul style="list-style-type: none"> File password authentication failed when access was required. 	<ul style="list-style-type: none"> Set a correct password and perform password authentication again.
440EH	Security function error	<ul style="list-style-type: none"> The security function was activated and password authentication cannot be performed. Register/cancel file password was attempted on a file set to permanent PLC lock. 	<ul style="list-style-type: none"> Set a correct password and perform password authentication again after a certain period of time. It is necessary to delete the whole project to delete the file set to permanent PLC lock.
440FH	Security function error	<ul style="list-style-type: none"> An operation was performed to the firmware update prohibited file with a file password set. 	<ul style="list-style-type: none"> Disable the file password setting.
4412H	Security function error	<ul style="list-style-type: none"> The security key cannot be registered to the CPU module due to failure of the internal memory where the security key is registered. Or, the security key of the CPU module cannot be deleted. 	<ul style="list-style-type: none"> Hardware failure of the CPU module. Replace the CPU module.
4416H	Security function error	<ul style="list-style-type: none"> Since the CPU module is in lock or unlock operation, the requested processing cannot be performed. 	<ul style="list-style-type: none"> Request the processing after the lock or unlock operation ends.
4422H	Security function error	<ul style="list-style-type: none"> The access target CPU module does not support the security key information stored in the engineering tool. 	<ul style="list-style-type: none"> Change the security key information version of the engineering tool in accordance with the version supported by the target CPU module.
4423H	Security function error	<ul style="list-style-type: none"> The specified target of security key operation is inaccurate. 	<ul style="list-style-type: none"> Set target of security key operation to CPU module.
480CH	iQ Sensor Solution related error	<ul style="list-style-type: none"> The specified command cannot be executed because the automatic detection of connected device function of iQ Sensor Solution is being executed. 	<ul style="list-style-type: none"> Execute the command again after the automatic detection processing ends.
480DH	iQ Sensor Solution related error	<ul style="list-style-type: none"> The specified command cannot be executed because the communication setting reflection function of iQ Sensor Solution is being executed. 	<ul style="list-style-type: none"> Execute the command again after the communication setting reflection processing ends.
480EH	iQ Sensor Solution related error	<ul style="list-style-type: none"> The specified command cannot be executed because the monitor function of iQ Sensor Solution is being executed. The specified command cannot be executed because the sensor parameter read/write function of iQ Sensor Solution is being executed. 	<ul style="list-style-type: none"> Execute the function again after a while. Execute the command again after the sensor parameter read/write processing ends.
4A00H	Network error	<ul style="list-style-type: none"> Access to the specified station cannot be made since the routing parameters are not set to the start source CPU module and/or relay CPU module. The third byte of the IP address (network number) specified by the IP communication test and the third byte of the IP address of the CPU module that starts the IP communication test are duplicated. The CPU module that performs IP packet transfer is not the control CPU of the CC-Link IE module, which is on the path that IP packets travel. 	<ul style="list-style-type: none"> Set to the related stations the routing parameters for access to the specified station. Retry after a while. Or, start communication after checking that the system for data routing has started. Do not duplicate the third byte of the IP address (network number) specified by the IP communication test and the third byte of the IP address of the CPU module that starts the IP communication test. Set the CPU module that performs IP packet transfer as the control CPU of the CC-Link IE module, which is on the path that IP packets travel.
4A01H	Network error	<ul style="list-style-type: none"> The network of the number set to the routing parameters does not exist. The specified CPU module cannot be communicated through the network that is not supported by the CPU module. A communication path which is not compatible with the specified CPU module is specified. 	<ul style="list-style-type: none"> Check and correct the routing parameters set to the related stations. Set communication through the network that is supported by the specified CPU module.
4A02H	Network error	<ul style="list-style-type: none"> Access to the specified station cannot be made. 	<ul style="list-style-type: none"> Check the network module for error, or check that the modules are not in offline. Check if the network numbers/PC numbers are correctly set.
4B00H	Target module error	<ul style="list-style-type: none"> An error occurred in the access destination or relay station. The specified transfer setup (request destination module number) is invalid. 	<ul style="list-style-type: none"> Take corrective action after checking the error that occurred at the specified access destination or the relay station to the accessed station. Check the transfer setup (request destination module number or PLC number) in the request data of SLMP/MC protocol. Check the stop error, and take action.
4B02H	Target module error	<ul style="list-style-type: none"> The request is not addressed to the CPU module. 	<ul style="list-style-type: none"> Perform operation to a module that can execute the specified function.
4B03H	Target module error	<ul style="list-style-type: none"> The specified route is not supported by the specified CPU module firmware version. 	<ul style="list-style-type: none"> Check whether the specified route is supported or not. Check the stop error, and take action.

Error code	Error name	Error details and cause	Action
4C00H	Data logging function error	<ul style="list-style-type: none"> There is not enough free space for storing. 	<ul style="list-style-type: none"> Increase the free space, and create the result file again.
4C01H	Data logging function error	<ul style="list-style-type: none"> The result file cannot be written to the target memory because the SD memory card is write-protected or the folder/file structure is incorrect. 	<ul style="list-style-type: none"> Unlock the write protect switch of the SD memory card, and write the result file again. Check that the SD memory card is not damaged. Check that the file/folder to be used in the SD memory card has not been deleted.
4C02H	Data logging function error	<ul style="list-style-type: none"> The SD memory card was removed while the data logging function was being executed (data logging status: Collecting, Trigger waiting (collecting before trigger), Collecting after trigger, or Saving the logging data). 	<ul style="list-style-type: none"> Insert the SD memory card, and execute the function again.
4C03H	Data logging function error	<ul style="list-style-type: none"> The number of files in the root directory and subdirectory in the target memory exceeded the limit. 	<ul style="list-style-type: none"> Increase the free space of the drive (memory), and execute the function again. Delete files in the drive (memory), and execute the function again.
4C06H	Data logging function error	<ul style="list-style-type: none"> System error 	<ul style="list-style-type: none"> Check the specified data, and write it to the CPU module again.
4C10H	CPU module backup/restoration function error	<ul style="list-style-type: none"> The maximum allowable capacity is exceeded. The maximum allowable number of files is exceeded. The upper limit of the backup folder number is exceeded. The maximum length (255 characters) of the file path is exceeded. 	<ul style="list-style-type: none"> Increase the free space of the SD memory card and CPU module, and execute the function again. Delete files in the SD memory card and CPU module, and execute the function again. Delete backup data in the SD memory card and CPU module, and execute the function again. Check and correct the folder structure or folder/file names of backup target data, and execute the data backup function again.
4C11H	CPU module backup/restoration function error	<ul style="list-style-type: none"> An SD memory card is not inserted. An SD memory card is disabled by SM606 (SD memory card forced disable instruction). 	<ul style="list-style-type: none"> Insert or re-insert an SD memory card, and execute the function again. Enable the SD memory card operation, and execute the function again.
4C12H	CPU module backup/restoration function error	<ul style="list-style-type: none"> Reading/writing of data from/to an SD memory card completed with an error. 	<ul style="list-style-type: none"> Check that an SD memory card is inserted, and execute the function again. Replace the SD memory card, and execute the function again. The backup data may have been corrupted. Execute the data restoration function using another backup data.
4C13H	CPU module backup/restoration function error	<ul style="list-style-type: none"> Reading/writing of data from/to the CPU built-in memory completed with an error. The backup target files opened in the CPU built-in memory are duplicated. 	<ul style="list-style-type: none"> Back up data in the CPU built-in memory, initialize the memory, and write the data back to the original memory. Then, execute the data backup/restoration function. The possible cause is a hardware failure of the restoration target CPU module. Execute the data restoration function to another CPU module. Execute the function again after a while.
4C14H	CPU module backup/restoration function error	<ul style="list-style-type: none"> The CPU module data backup/restoration function cannot be executed because a file password is set to the data. Data was restored to the CPU module where the same data with a file password has already been stored. 	<ul style="list-style-type: none"> Delete file passwords, and execute the CPU module data backup/restoration function.
4C15H	CPU module backup/restoration function error	<ul style="list-style-type: none"> The function that cannot be executed simultaneously with such as the file transfer function (FTP) is being executed. 	<ul style="list-style-type: none"> Execute the function again after a while.
4C17H	CPU module backup/restoration function error	<ul style="list-style-type: none"> The backed up CPU module and restoration target destination CPU module models were different when restoration was executed. 	<ul style="list-style-type: none"> Execute restoration again with the same CPU module model as the backed up CPU module.
4C18H	CPU module backup/restoration function error	<ul style="list-style-type: none"> Data was restored while the operating status of the CPU module is in RUN or PAUSE. 	<ul style="list-style-type: none"> Change the operating status of the CPU module to STOP, and execute the function again.

Error code	Error name	Error details and cause	Action
4C19H	CPU module backup/restoration function error	<ul style="list-style-type: none"> The data restoration function was executed with backup files (\$BKUP_CPU_INF.BSC and BKUP_CPU.BKD) not structured properly. Data (file(s)) is missing in the backup file (\$BKUP_CPU_INF.BSC) in the backup data folder. The data restoration function was executed with a folder where no backup files (\$BKUP_CPU_INF.BSC, BKUP_CPU.BKD, and BKUP_CPU_DEVLAB.BKD) are stored. The backed up CPU module and restoration target destination CPU module models were different when restoration was executed. 	<ul style="list-style-type: none"> The backup data may have been corrupted. Execute the data restoration function using another backup data. Execute restoration again with the same CPU module model as the backed up CPU module.
4C1AH	CPU module backup/restoration function error	<ul style="list-style-type: none"> A value outside the allowable range was set to the operation mode. An out-of-range value was set for the CPU module automatic replacement function Restore target data setting (SD9351). A folder with a value that matches the restoration target date folder setting value or number folder setting value does not exist in the SD memory card. The restoration target data setting value is out of range. The restoration target date folder setting value or number folder setting value is out of range. 	<ul style="list-style-type: none"> Check the operation mode setting value, and execute again. Review the CPU module automatic replacement function Restore target data setting value, and execute again. Check and correct the restoration target date folder setting value or number folder setting value, and execute the function again. Check and correct the restoration target data setting value, and execute the function again.
4C1BH	CPU module backup/restoration function error	<ul style="list-style-type: none"> The data restoration function was executed to the CPU module whose status (such as programs, parameters, and file structure) differs from that of when the data backup function was executed. 	<ul style="list-style-type: none"> Match the CPU module status to the one at the time of backup, and execute the function again. Store 0 (All target data) to SD954 (Restoration target data setting) and execute the automatic restoration.
4C1CH	CPU module backup/restoration function error	<ul style="list-style-type: none"> An SD memory card is not inserted. The SD memory card is disabled by SM606 (SD memory card forced disable instruction). The SD memory card is write-protected. 	<ul style="list-style-type: none"> Insert or re-insert an SD memory card, and execute the function again. Enable the SD memory card operation, and execute the function again. Cancel the write protection, and execute the function again.
4C1FH	CPU module data backup/restoration function error	<ul style="list-style-type: none"> The specified command cannot be executed because the CPU module data backup/restoration function is being executed. 	<ul style="list-style-type: none"> Execute the command again after the data backup/restoration processing ends.
4C20H	CPU module backup/restoration function error	<ul style="list-style-type: none"> The data backup/restoration function was executed while the CPU module is in a state where this function cannot be executed. 	<ul style="list-style-type: none"> Check that the FX5U/FX5UC CPU module's serial No. is compatible with the backup function (16Y**** or later). Initialize the CPU built-in memory, and execute the data restoration function again.
4C40H	File transfer function (FTP client) error	<ul style="list-style-type: none"> When files are specified by using wild card characters for the file transfer function instruction, the number of files matched exceeds the upper limit of the transferable number of files. When files are specified by using wild card characters for the file transfer function instruction, no files are matched. 	<ul style="list-style-type: none"> Check and correct the wild card specification. Check if the specified folder path exists.
4C43H	File transfer function (FTP client) error	<ul style="list-style-type: none"> The number of processing completed files for sending or acquiring FTP client file is mismatched with the total number of processing files. 	<ul style="list-style-type: none"> Execute the function again.
4C44H	File transfer function (FTP client) error	<ul style="list-style-type: none"> The file transfer function (FTP client) is executed while the backup/restoration function are being executed. 	<ul style="list-style-type: none"> Execute the File transfer function (FTP client) again after the backup/restoration function is completed.



Error codes of the CC-Link IE Field Network Basic (CFC0H to CFFFH)

The following table lists the error codes detected by the CC-Link IE Field Network Basic function.

Error code	Error name	Error details and cause	Action
CFC0H	Cyclic transmission error (master station)	<ul style="list-style-type: none"> Unable to execute cyclic transmission because multiple master stations exist in the same network address. 	<ul style="list-style-type: none"> Check the existence status of master station in network.
CFC1H	Cyclic transmission error (master station)	<ul style="list-style-type: none"> Unable to execute cyclic transmission because the error occurred in cyclic transmission. 	<ul style="list-style-type: none"> Take measures to reduce noise. If the same error is displayed again, please contact your local Mitsubishi representative.
CFC8H	Cyclic transmission error (master station)	<ul style="list-style-type: none"> Unable to execute cyclic transmission because the slave station controlled by other master station exists. 	<ul style="list-style-type: none"> Check the existence status of master station in network. Check the slave station where the error occurred.
CFC9H	Cyclic transmission error (master station)	<ul style="list-style-type: none"> Unable to execute cyclic transmission because the slave station of the same IP address exists in the same network address. 	<ul style="list-style-type: none"> Check the existence status of slave station in network. Check the slave station where the error occurred.
CFD0H	Master station error	<ul style="list-style-type: none"> The port No. (61450) used in CC-Link IE Field Network Basic has already been used. 	<ul style="list-style-type: none"> Check the port No. used in Ethernet function.
CFD1H	Master station error	<ul style="list-style-type: none"> Invalid value has been set in subnet mask. 	<ul style="list-style-type: none"> Check the parameter setting.
CFE0H	Cyclic transmission error (slave station)	<ul style="list-style-type: none"> The cyclic transmission was executed for the slave station controlled by other master station. 	<ul style="list-style-type: none"> Check the existence status of master station in network. Check the slave station where the error occurred.
CFE1H	Cyclic transmission error (slave station)	<ul style="list-style-type: none"> The unusable number of occupied stations has been specified from master station. 	<ul style="list-style-type: none"> Check the number of occupied stations setting in master station parameter (Network Configuration Settings).
CFE8H	Cyclic transmission error (slave station)	<ul style="list-style-type: none"> There is no response from slave station. 	<ul style="list-style-type: none"> Check the slave station disconnection detection setting in master station parameter (Network Configuration Settings). Check the existence status of slave station in network. Check the slave station which is disconnected. Take measures to reduce noise.
CFE9H	Cyclic transmission error (slave station)	<ul style="list-style-type: none"> The slave station of the same IP address has existed in the same network address. 	<ul style="list-style-type: none"> Check the slave station where the error occurred.
CFF0H	Slave station error	<ul style="list-style-type: none"> The error occurred in slave station. 	<ul style="list-style-type: none"> Check the slave station where the error occurred.

Appendix 4 Parameter List

A parameter list is shown below.

System parameters

Item			Parameter No.
I/O Assignment Setting	Model Name	—	0203H
	Intelligent Module No.	—	0200H
	Serial Communication ch	—	0200H
	Number of Input Points	—	0200H
	Number of Output Points	—	0200H
	CPU Module Operation at Error Detection	—	0200H

CPU parameters

Item			Parameter No.
Name Setting	Title Setting	Title	3100H
	Comment Setting	Comment	3101H
Operation Related Setting	RUN Contact Setting	RUN Contact Operation	3201H
	Remote Reset Setting	Remote Reset	3202H
	Clock Related Setting	Time Zone	3209H
Comment		3209H	
Interrupt Settings	Fixed Scan Interval Setting	Interrupt Setting from Internal Timer	3A00H
	Fixed Scan Execution Mode Setting	Fixed Scan Execution Mode	3A00H
	Interrupt Priority Setting from Module	Multiple Interrupt	3A01H
		Interrupt Priority	3A01H
Index Register Save/Restoration		3A00H	
Service Processing Setting	Device/Label Access Service Processing Setting	Specifying Method	3B00H
File Setting	Initial Value Setting	Setting of Device Initial Value Use Or Not	3301H
		Target Memory	3301H
		Global Device Initial Value File Name	3301H
Memory/Device Setting	Device/Label Memory Area Setting	Option Battery Setting	320AH
		Device/Label Memory Area Capacity Setting	3400H
		Device/Label Memory Area Detailed Setting	3401H
	Index Register Setting	Points Setting	3402H
	Pointer Setting	Total Points	340BH
	Internal Buffer Capacity Setting	Total Capacity	340AH
RAS Setting	Scan Time Monitoring Time (WDT) Setting	Initial Scan	3500H
		After 2nd Scan	3500H
	Constant Scan Setting	Constant Scan	3503H
	Error Detections Setting	Battery Error	3501H
		Module Verify Error	3501H
	CPU Module Operation Setting at Error Detected	Instruction Execution Error	3501H
		Memory Card Error	3501H
		Module Verify Error	3501H
		System Configuration Error	3501H
	LED Display Setting	ERROR LED	3502H
		BATTERY LED	3502H
Event History Setting	Save Destination	3504H	
	Storage Capacity Setting per File	3504H	
Program Setting	Program Setting	Program Setting	3700H
	FB/FUN File Setting	FB/FUN File Setting	3702H
	Program Capacity Setting	Program Capacity Setting	3703H

Item			Parameter No.
SFC Setting	SFC Program Setting	To Use or Not to Use SFC	3C10H
	SFC Program Start Mode Setting	SFC Program Start Mode	3C00H
	Start Conditions Setting	Start Conditions	3C00H
	FX3 Compatible Transition Operation Mode Setting	FX3 Compatible Transition Operation Mode	3C10H

Module parameters

Ethernet Port

Item			Parameter No.	
Basic Settings	Own Node Settings	IP Address	A012H	
		Communication Data Code	A030H	
	CC-Link IEF Basic Setting	To Use or Not to Use CC-Link IEF Basic Setting	7A00H	
		Network Configuration Settings	7A00H	
		Refresh Settings	7420H	
	MODBUS/TCP Settings	To Use or Not to Use MODBUS/TCP Setting	A031H	
		Device Assigned	A0B2H	
	External Device Configuration	External Device Configuration	A031H	
	Application Settings	FTP Server Settings	FTP Server	A037H
			Login Name	A037H
Advanced Settings			A037H	
Web Server Settings		To Use or Not to USE Web Server Settings	A035H	
		HTTP Port No.	A035H	
		Account Settings	A035H	
Security		IP Filter Settings	A03AH	
		Disable Direct Connection with MELSOFT	A034H	
		Do Not Respond to CPU Module Search	A024H	
Time Setting		Time Setting (SNTP client)	A039H	
Simple PLC Communication Setting		Simple PLC Communication Setting	7A10H	
FTP Client Settings		To Use or Not to Use FTP Client Settings	A03DH	
		FTP Server Specification	A03DH	
		Login Name	A03DH	
		Password	A03DH	
	Connection Method	A03DH		
	Port No.	A03DH		

485 Serial Port

■MELSOFT Connection

Item			Parameter No.
Basic Settings	Communication Protocol Type	Communication Protocol Type	8000H

■Non-Protocol Communication

Item			Parameter No.
Basic Settings	Communication Protocol Type	Communication Protocol Type	8001H
	Advanced Settings	Data Length	8001H
		Parity Bit	8001H
		Stop Bit	8001H
		Baud Rate	8001H
		Header	8001H
		Header Setting Value	8001H
		Terminator	8001H
		Terminator Setting Value	8001H
		Control Mode (RS-232C)	8001H
		Control Mode (RS-485)	8001H
		Sum Check Code	8001H
Control Procedure	8001H		
Fixed Setting	8 bit Process Mode	8 Bit Processing Mode	8001H
	Time-out Period	Time-out Period	8001H
SM/SD Setting	Latch Setting	Advanced Settings	8001H
		8 Bit Process Mode	8001H
		Time-out Period	8001H
		Header Setting Value	8001H
		Terminator Setting Value	8001H
	FX3 Series Compatibility	SM/SD for Compatible	8001H

■MC Protocol

Item			Parameter No.
Basic Settings	Communication Protocol Type	Communication Protocol Type	8002H
	Advanced Settings	Data Length	8002H
		Parity Bit	8002H
		Stop Bit	8002H
		Baud Rate	8002H
		Sum Check Code	8002H
Fixed Setting	Station Number	Station Number	8002H
	Message Pattern	Message Pattern	8002H
	Time-out Period	Time-out Period	8002H
	Message waiting time	Message waiting time	8002H
SM/SD Setting	Latch Setting	Advanced Settings	8002H
		Station Number	8002H
		Message Pattern	8002H
		Time-out Period	8002H
		Message waiting time	8002H
	FX3 Series Compatibility	SM/SD for Compatible	8002H

A

■MODBUS_RTU Communication

Item			Parameter No.
Basic Settings	Communication Protocol Type	Communication Protocol Type	8003H
	Advanced Settings	Parity Bit	8003H
		Stop Bit	8003H
		Baud Rate	8003H
Fixed Setting	Host Station No.	Host Station No.	8003H
	Slave Response Timeout	Slave Response Timeout	8003H
	Broadcast Delay	Broadcast Delay	8003H
	Message to Message Delay	Message to Message Delay	8003H
	Timeout Retry Count Setting	Timeout Retry Count Setting	8003H
Modbus Device Assigned	Modbus Device Assigned	Device Assigned	8003H
SM/SD Setting	Latch Setting	Advanced Settings	8003H
		Host Station No.	8003H
		Slave Response Timeout	8003H
		Broadcast Delay	8003H
		Message to Message Delay	8003H
		Timeout Retry Count Setting	8003H
	FX3 Series Compatibility	SM/SD for Compatible	8003H

■Predefined Protocol Support Function

Item			Parameter No.
Basic Settings	Communication Protocol Type	Communication Protocol Type	8004H
	Advanced Settings	Data Length	8004H
		Parity Bit	8004H
		Stop Bit	8004H
		Baud Rate	8004H

■Inverter Communication

Item			Parameter No.
Basic Settings	Communication Protocol Type	Communication Protocol Type	8005H
	Advanced Settings	Data Length	8005H
		Parity Bit	8005H
		Stop Bit	8005H
		Baud Rate	8005H
Fixed Setting	Response Waiting Time	Response Waiting Time	8005H
SM/SD Setting	Latch Setting	Advanced Settings	8005H
		Response Waiting Time	8005H
	FX3 Series Compatibility	SM/SD for Compatible	8005H

■N:N Network

Item			Parameter No.
Basic Settings	Communication Protocol Type	Communication Protocol Type	8006H
Fixed Setting	Host Station No.	Host Station No.	8006H
	Total Number of Local Station	Total Number of Local Station	8006H
	Refresh Range	Refresh Range	8006H
	Timeout Retry Count Setting	Timeout Retry Count Setting	8006H
	Monitoring Time	Monitoring Time	8006H
Link Device	Link Device Bit	Device	8006H
	Link Device Word	Device	8006H
SM/SD Setting	Latch Setting	Host Station No.	8006H
		Total Number of Local Station	8006H
		Refresh Range	8006H
		Timeout Retry Count Setting	8006H
		Monitoring Time	8006H
	FX3 Series Compatibility	SM/SD for Compatible	8006H

■Parallel Link

Item			Parameter No.
Basic Settings	Communication Protocol Type	Communication Protocol Type	8007H
Fixed Setting	Station Setting	Station Setting	8007H
	Link Mode	Link Mode	8007H
	Error Judgement Time	Error Judgement Time	8007H
Link Device	Link Device Bit	Device	8007H
	Link Device Word	Device	8007H
SM/SD Setting	Latch Setting	Station Setting	8007H
		Link Mode	8007H
		Error Judgement Time	8007H
	FX3 Series Compatibility	SM/SD for Compatible	8007H

A

High Speed I/O Settings

Item			Parameter No.
Input Function	General/Interrupt/Pulse catch	General/Interrupt/Pulse catch	8010H
	High Speed Counter	High Speed Counter	8010H
	Pulse Width Measurement	Pulse Width Measurement	8010H
Output Function	Positioning	Positioning	8010H
	PWM	PWM	8010H
Input Check	Input Response Time	Input Response Time	8010H
	Input Interrupt	Rising	8010H
		Falling	8010H
		Rising+Falling	8010H
	Pulse Catch	Pulse Catch	8010H
	High Speed Counter	CH1 to 8	8010H
	Pulse Width Measurement	CH1 to 4	8010H
	Positioning	External Start Signal Positive Logic (Axis 1 to 4)	8010H
		External Start Signal Negative Logic (Axis 1 to 4)	8010H
		Interrupt Input Signal 1 High Speed (Axis 1 to 4)	8010H
		Interrupt Input Signal 1 Standard Positive Logic (Axis 1 to 4)	8010H
		Interrupt Input Signal 1 Standard Negative Logic (Axis 1 to 4)	8010H
		Near-point Dog Signal (Axis 1 to 4)	8010H
		Zero Signal Positive Logic (Axis 1 to 4)	8010H
Zero Signal Negative Logic (Axis 1 to 4)		8010H	
Interrupt Input Signal 2 (Axis 1 to 4)	8010H		
Output Confirmation	Positioning	Pulse Output (PULSE) (Axis 1 to 4)	8010H
		Pulse Output (SIGN) (Axis 1 to 4)	8010H
		Pulse Output (CW) (Axis 1 to 4)	8010H
		Pulse Output (CCW) (Axis 1 to 4)	8010H
		Clear Signal (Axis 1 to 4)	8010H
	PWM	CH1 to 4	8010H

■General/Interrupt/Pulse catch

Item			Parameter No.
General/Interrupt/Pulse Catch	General/Interrupt/Pulse Catch Setting	X0 to X17	8010H

■High Speed Counter

Item		Parameter No.		
Basic Settings	Use/Do Not Use Counter	Use/Not Use	8010H	
	Operation Mode	Operation Mode	8010H	
	Pulse Input Mode	Pulse Input Mode	8010H	
	Preset Input	Preset Input Enable/Disable		8010H
		Input Logic		8010H
		Preset Value		8010H
		Input Comparison Enable/Disable		8010H
		Control Switch		8010H
	Enable Input	Enable Input Enable/Disable		8010H
		Input logic		8010H
	Ring Length Setting	Ring Length Enable/Disable		8010H
		Ring Length		8010H
Measurement Unit Time	Measurement Unit Time		8010H	
Pulse No. of per Rotation	Pulse No. of per Rotation		8010H	
High Speed Compare Table	Counter CH	—	8010H	
	Comparison Type	—	8010H	
	Output Destination Device	—	8010H	
	Comparison Value 1 Specification Method	—	8010H	
	Comparison Value 1 Direct	—	8010H	
	Comparison Value 1 Indirect	—	8010H	
	Comparison Value 2 Specification Method	—	8010H	
	Comparison Value 2 Direct	—	8010H	
	Comparison Value 2 Indirect	—	8010H	
Multi-point Output High Speed Compare Table	Enable/Disable	—	8010H	
	Device	—	8010H	
	Comparison Value	—	8010H	
	Output Device	—	8010H	
	Output Data (HEX)	—	8010H	
	Table Data/Counter CH/Output Data/Points	—	8010H	
Occupied input (X) Explanation	1-Phase 1 Count (S/W Updown Switch)	CH1 to 8	8010H	
	1-Phase 1 Count (H/W Updown Switch)	CH1 to 8	8010H	
	1-Phase 2 Input	CH1 to 8	8010H	
	2 Phase Counts	CH1 to 8	8010H	
Other	Specification method for high speed counter	Specification method for high speed counter	8010H	

■Pulse Width Measurement

Item		Parameter No.	
Basic Settings	Use Pulse Width Measurement	Use/Not Use	8010H
	Input Signal	Input Signal	8010H
	Logical Switch	Logical Switch	8010H
	Measurement Mode	Measurement Mode	8010H

■ Positioning

Item			Parameter No.
Basic Settings	Basic Parameters 1	Pulse Output Mode	8010H
		Output Device (PULSE/CW)	8010H
		Output Device (SIGN/CCW)	8010H
		Rotation Direction Setting	8010H
		Unit Setting	8010H
		Pulse No. of per Rotation	8010H
		Movement Amount per Rotation	8010H
		Position Data Magnification	8010H
	Basic Parameters 2	Interpolation Speed Specified Method	8010H
		Max. Speed	8010H
		Bias Speed	8010H
		Acceleration Time	8010H
		Deceleration Time	8010H
	Detailed Setting Parameter	External Start Signal Enable/Disable	8010H
		External Start Signal Device No.	8010H
		External Start Signal Logic	8010H
		Interrupt Input Signal 1 Enable/Disable	8010H
		Interrupt Input Signal 1 Mode	8010H
		Interrupt Input Signal 1 Device No.	8010H
		Interrupt Input Signal 1 Logic	8010H
		Interrupt Input Signal 2 Logic	8010H
	OPR Parameters	OPR Enable/Disable	8010H
		OPR Direction	8010H
		Starting Point Address	8010H
		Clear Signal Output Enable/Disable	8010H
		Clear Signal Output Device No.	8010H
		OPR Dwell Time	8010H
		Near-point Dog Signal Device No.	8010H
		Near-point Dog Signal Logic	8010H
		Zero Signal Device No.	8010H
		Zero Signal Logic	8010H
		Zero Signal OPR Zero Signal Counts	8010H
		Zero Signal Count Start Time	8010H
Axis Common Parameter	When Stop Error Occurs, All Module Reset Enabled/Disabled	8010H	
Positioning Data	Device	—	8010H
	Control Method	—	8010H
	Axis to be Interpolated	—	8010H
	Positioning Address	—	8010H
	Command Speed	—	8010H
	Dwell Time	—	8010H
	Interrupt Counts	—	8010H
	Interrupt Input Signal 2 Device No.	—	8010H
	Jump Destination Table No.	—	8010H
	M No. for Jump Condition	—	8010H

■PWM

Item			Parameter No.
Basic Settings	Use PWM Output	Use/Not Use	8010H
	Output Signal	Output Signal	8010H
	Pulse Width/Cycle Unit	Pulse Width/Cycle Unit	8010H
	Output Pulse Logic	Output Pulse Logic	8010H
	Pulse Width	Pulse Width	8010H
	Cycle	Cycle	8010H

Input Response Time Setting

Item			Parameter No.
Input Response Time	X0 to X577	—	8011H

Analog Input Setting

Item			Parameter No.
Basic Settings	A/D Conversion Enable/Disable Setting Function	A/D Conversion Enable/Disable Setting	8014H
	A/D Conversion Method	Average Processing Specify	8014H
		Time Average Counts Average Moving Average	8014H
Application Settings	Warning Output Function	Process Alarm Warning Setting	8014H
		Process Alarm Upper Upper Limit Value	8014H
		Process Alarm Upper Lower Limit Value	8014H
		Process Alarm Lower Upper Limit Value	8014H
		Process Alarm Lower Lower Limit Value	8014H
	Over Scale Detection	Over Scale Detection Enable/Disable	8014H
	Scaling Setting	Scaling Enable/Disable	8014H
		Scaling Upper Limit Value	8014H
		Scaling Lower Limit Value	8014H
	Shift Function	Shift Amount	8014H
Digital Clip Setting	Digital Clip Enable/Disable	8014H	

Analog Output Setting

Item			Parameter No.
Basic Settings	D/A Conversion Enable/Disable Setting Function	D/A Conversion Enable/Disable Setting	8015H
	D/A Output Enable/Disable Setting	D/A Output Enable/Disable Setting	8015H
Application Settings	Warning Output Function	Warning Output Setting	8015H
		Warning Upper Limit Value	8015H
		Warning Lower Limit Value	8015H
	Scaling Setting	Scaling Enable/Disable	8015H
		Scaling Upper Limit Value	8015H
		Scaling Lower Limit Value	8015H
	Shift Function	Shifting Amount	8015H
	Analog Output HOLD/CLEAR Setting	HOLD/CLEAR Setting	8015H
		HOLD Setting Value	8015H

Extended Board Setting

Item			Parameter No.
Basic Settings	Extended Board	—	7000H
	Communication Protocol Type	—	*1

*1 The parameter No. varies according to the communication protocol type. For details, refer to  Page 525 485 Serial Port.

Memory card parameters

Item			Parameter No.
Boot Setting	Boot Setting	Clear the CPU built-in memory before boot	2000H
		Boot File Setting	2000H
	Setting of File/Data Use or Not in Memory Card	Module Extended Parameter	2010H

Appendix 5 Event List

Information including errors detected in the CPU module, expansion board, expansion adapter and intelligent module, and errors that occur in the network are collected and saved in the CPU built-in memory or SD memory card by the CPU module. (Page 194 Event History Function) When an event occurs, its event code and details can be read by using an engineering tool.

Check the User's Manual of each module for a list of events related to the intelligent function module.

How to read the event list

The event list contains the following information.

Item	Description
Event code	ID number assigned to an event
Event type	Type of an event
Event category	Category of an event
Detected event	Description of a detected event
Detailed information 1 to 3	Details of a detected event

Detailed information

The following table lists the details of information displayed in the detailed information 1 to 3.

Detailed information	Item	Description
Detailed information 1	Operation source information	Information on the operation source <ul style="list-style-type: none">• Connection port (Connection information such as Ethernet)• Module number• Network number• Station number• IP address
	Event history file information	Information on the event history file
Detailed information 2	Communication speed and communication mode	Information on the communication speed and the communication mode
	Drive/file information	Information on the corresponding drive name and file name
	Device/label information	Information on the corresponding device and label
Detailed information 3	—	—

Event list

The following table lists events related to the CPU module.

Event code	Event type	Event category	Detected event	Description	Detailed information		
					Detailed information 1	Detailed information 2	Detailed information 3
00430	System	Info	SFC program continue start not possible	An SFC program could not be resumed, and an initial start was performed.	—	—	—
00800		Warning	Link-down	The CPU module has entered into the link-down state as a result of an operation such as disconnecting a network cable between the CPU module and an external device.	Operation source information	Communication speed and communication mode	—
00904			Socket communication send error	Sending a message over socket communication failed.			
00907			Divided message receive timeout error	<ul style="list-style-type: none"> All the data could not be received within the period specified by the response monitoring timer. Data of the total data length could not be received. The remaining part of the message divided into the TCP/IP level could not be received within the period specified by the response monitoring timer. 			
01000 and after		Error	When a self-diagnostic error occurs, the error is stored as an event.				
2A200	Operation	Warning	Memory initialization	The memory was initialized.	Operation source information	Drive/file information	—
2A201			Device/label zero clear	Values in a device or label were cleared to zero.		Device/label information	

Appendix 6 Processing Time

Each of the processing time that constitutes the scan time is as follows.

Data logging function processing time

Shows the processing time taken to store the data when executing the data logging function. Shows the minimum specified time value that can collect without losing the data when executing the continuous logging.

CSV file output format^{*1}, Binary file output format

Shows the collection interval at which data can be collected under the following conditions.

- Scan time = 5 ms
- Internal buffer capacity setting = 80K bytes as per one setting (default setting)
- Collection setting = Time specification (data collection at time interval)
- Data setting = Data register (D) (Data type: Word (signed))
- Binary Output setting = Output date (output format is default), Output data sampling interval, Output index, Output comments
- Save setting = Operation when exceeds the number of files: Overwriting, File switch timing: 10000
- SD memory card: NZ1MEM-4GBSD used

Number of points		Collection interval where data can be collected
8 points	(8 points ×1 setting)	10 ms
16 points	(16 points ×1 setting)	15 ms
64 points	(64 points ×1 setting)	45 ms
128 points	(128 points ×1 setting)	100 ms
256 points	(128 points ×2 setting)	150 ms
512 points	(128 points ×4 setting)	250 ms

Precautions

- If the SD memory card is accessed frequently during operations with the engineering tool or CPU module logging setting tool or with operations using FTP, set a longer collection interval than the interval given above.
- If a load on Ethernet communication such as socket communication is high, set a longer collection interval than the interval given above.

*1 Only FX5U/FX5UC CPU module is supported.

SFC program processing time

This section describes the time required for SFC program processing. For details on the SFC program, refer to the following.
 MELSEC iQ-F FX5 Programming Manual (Program Design)

SFC program processing performance

The SFC program execution time can be calculated with the following formula.

- SFC program execution time = (A) + (B) + (C)

Item	Description	
(A)	SFC processing time	☞ Page 536 SFC processing time
(B)	Operation output processing time for all steps	This is the total processing time for each instruction used for operation output for all steps in the active status.
(C)	Processing time for all transition conditions	This is the total processing time for each instruction used for transition conditions associated with each step in the active status.

For the processing time for the SFC control instruction, refer to the following.

MELSEC iQ-F FX5 Programming Manual (Instructions, Standard Functions/Function Blocks)

■SFC processing time

The following table lists the details of the types of the SFC processing time (A).

- The SFC processing time (A) = (a) + (b) + (c) + (d) + (e) + (f) + (g) + (h)

Item	Processing time calculation (unit: μ s)		Description
(a)	Active block processing time	Active block processing time coefficient \times Number of active blocks	This is the system processing time required to execute active blocks.
(b)	Inactive block processing time	Inactive block processing time coefficient \times Number of inactive blocks	This is the processing time required to execute inactive blocks.
(c)	Nonexistent block processing time	Nonexistent block processing time coefficient \times Number of nonexistent blocks	This is the system processing time required to execute blocks that have not been created.
(d)	Active step processing time	Active step processing time coefficient \times Number of active steps	This is the time required to execute active steps.
(e)	Active transition processing time	Active transition processing time coefficient \times Number of active transitions	This is the system processing time required to execute active transitions.
(f)	Transition establishment step processing time	Transition establishment step processing time coefficient \times Number of transitions	This is the time required to turn off active steps when transitions are established.
(g)	SFC END processing time	SFC END processing time	This is the system processing time required for SFC END processing.
(h)	Operation output processing time	Action processing time coefficient \times Number of actions	This is the system processing time required to process operation outputs.

The following table lists the coefficient values for each processing time.

Item			Coefficient value		
			FX5U/FX5UC CPU module		
			Program capacity setting: 64000 steps	Program capacity setting: 128000 steps	
(a)	Active block processing time coefficient		2.6 μ s	2.6 μ s	
(b)	Inactive block processing time coefficient		1.2 μ s	1.2 μ s	
(c)	Nonexistent block processing time coefficient		0.5 μ s	0.5 μ s	
(d)	Active step processing time coefficient	FX3 Compatible Transition Operation Mode Enable	5.8 μ s	8.2 μ s	
		FX3 Compatible Transition Operation Mode Disable	5.4 μ s	7.7 μ s	
(e)	Active transition processing time coefficient		2.5 μ s	5.6 μ s	
(f)	Transition establishment step processing time coefficient	Hold step	FX3 Compatible Transition Operation Mode Enable	21.9 μ s	28.1 μ s
			FX3 Compatible Transition Operation Mode Disable	12.3 μ s	13.1 μ s
		Normal step	FX3 Compatible Transition Operation Mode Enable	22.9 μ s	29.2 μ s
			FX3 Compatible Transition Operation Mode Disable	17.6 μ s	22.1 μ s
(g)	SFC END processing time		2.4 μ s	2.4 μ s	
(h)	Operation output processing time coefficient		—	—	

Processing time until the file operation is completed

This section describes the processing time from the start of the file operation instruction until the completion of the file operation.

Changes in the processing time according to the number of files

The processing time changes according to the number of files stored in folders. The table below lists the processing time under the following conditions.

Condition

- Folder/file structure (drive 2: SD memory card)
- SD memory card: NZ1MEM-2GBSD used
- Size of each file to be operated: 1K byte
- The following table lists the instruction arguments of each file operation instruction.

Instruction name	First argument	Second argument	Third argument	Fourth argument	Fifth argument	Sixth argument	Seventh argument
SP.FDELETE	U1	K2	D0	"D001"	M0	—	—
SP.FCOPY	U1	D40	K2	"D001"	K2	"D002"	M40
SP.FMOVE	U1	D40	K2	"D001"	K2	"D002"	M40
SP.FRENAME	U1	K2	D0	"D001"	"D002"	M0	—
SP.FSTATUS	U1	K2	D0	"D001"	D10	M0	—

- File/folder structures except those shown below do not exist.

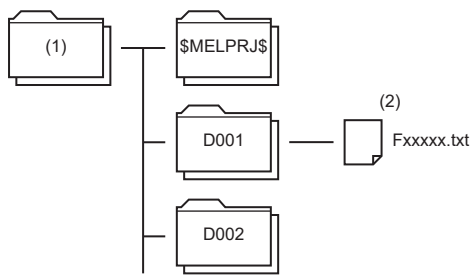

(1) Root directory (root folder)

(2) All file names are Fxxxx.txt (xxxxx: serial numbers starting from 00001).

- Overwriting setting: Not overwrite (SP.FCOPY, SP.FMOVE only)
- Target type setting: Folder specification
- Empty folder deletion setting: Delete folders even when they are not empty (SP.FDELETE only)

Processing time (Constant scan: None)

Instruction name	Number of operated files in the folder (D001)		
	1	10	100
SP.FDELETE	261ms	1600ms	14380ms
SP.FCOPY	1614ms	15173ms	138573ms
SP.FMOVE	115ms	162ms	119ms
SP.FRENAME	34ms	35ms	37ms
SP.FSTATUS	3ms	4ms	6ms

Changes in the processing time according to the file size

The processing time changes according to the size of the files stored in the folder. The table below lists the processing time under the following conditions.

■Condition

- Folder/file structure (drive 2: SD memory card)
- SD memory card: NZ1MEM-2GBSD used
- Number of files in the folder: 1
- The following table lists the instruction argument of each file operation instruction.

Instruction name	First argument	Second argument	Third argument	Fourth argument	Fifth argument	Sixth argument	Seventh argument
SP.FDELETE	U1	K2	D0	"D001\F00001.txt"	M0	—	—
SP.FCOPY	U1	D40	K2	"D001\F00001.txt"	K2	"D002"	M40
SP.FMOVE	U1	D40	K2	"D001\F00001.txt"	K2	"D002"	M40
SP.FRENAME	U1	K2	D0	"D001\F00001.txt"	"F00002.txt"	M0	—
SP.FSTATUS	U1	K2	D0	"D001\F00001.txt"	D10	M0	—

- File/folder structures except those shown below do not exist.

(1) Root directory (root folder)

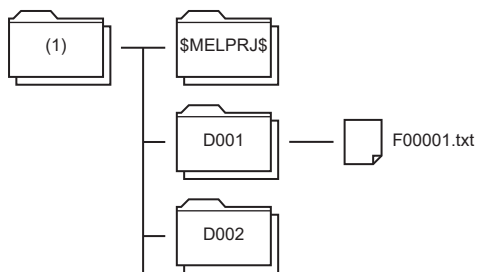

- Overwriting setting: Not overwrite (SP.FCOPY, SP.FMOVE only)
- Target type setting: Folder specification

■Processing time (Constant scan: None)

Instruction name	Number of operated files in the folder (D001)		
	100KB	1MB	16MB
SP.FDELETE	80ms	81ms	780ms
SP.FCOPY	2802ms	16289ms	285671ms
SP.FMOVE	4088ms	17319ms	299277ms
SP.FRENAME	26ms	26ms	28ms
SP.FSTATUS	13ms	12ms	10ms

Appendix 7 How to Use CPU Module Logging Configuration Tool

This appendix describes how to operate the CPU Module Logging Configuration Tool and configure the logging function.

Point

For the system configuration and procedure for using the data logging function, refer to the following.

 Page 166 Procedure for Using

Operating environment

For details on the operating environment for CPU Module Logging Configuration Tool, refer to following manual which is stored in the installer.

 CPU Module Logging Configuration Tool/GX LogViewer Installation Instructions (BCN-P5999-0506)

Installation/uninstallation

For the procedures for installing and uninstalling the CPU Module Logging Configuration Tool, refer to the following.

 CPU Module Logging Configuration Tool/GX LogViewer Installation Instructions (BCN-P5999-0506)

Starting the CPU Module Logging Configuration Tool

The CPU Module Logging Configuration Tool can be started by the following three methods.

■ Starting from the Start menu

After installing the CPU Module Logging Configuration Tool, you can start the tool by the following operation.

 [Start] ⇒ [All Programs] ⇒ [MELSOFT] ⇒ [Logging Function] ⇒ [CPU Module Logging Configuration Tool]

■ Starting from GX Works3

After starting GX Works3, you can start the tool by the following operation.

 [Tool] ⇒ [Logging Configuration Tool]

When the tool is started, the project information (connected device, transfer setup/setting, and display language) of GX Works3 is handed off.

■ Starting from GX LogViewer

Refer to the following manual.

 GX LogViewer Version 1 Operating Manual

Point

If an error message is displayed when the CPU Module Logging Configuration Tool is started, start it with administrator privileges.

Communication route

To connect the CPU module to a personal computer, use the following methods. (📄 Page 547 Transfer setup)

■ Connection through an RS-232C communication port

Connect the CPU module that is hooked up with an FX5-232-BD or FX5-232ADP with an RS-232C cable.

■ Connection through an USB port

Connect the FX5UJ CPU module with an USB cable.

■ Connection through an Ethernet port

- Connection via a hub

Connect the CPU module via a hub to a personal computer on the same local network. Note that IP address of the CPU module must be specified. Also the personal computer should have the same network address as the CPU module.

Restriction

Only local area network can be used for connections. Connections via the Internet are not allowed.

- Direct connection

One-to-one direct connection with an Ethernet cable is possible. This method requires no hub. Note that IP address of the CPU module need not be specified with this method.

Precautions

- Do not directly connect to a personal computer via LAN line. Load imposed on the LAN line adversely affect communications of other devices.
- Do not configure the direct connection setting when using one-to-one connection via a hub between the CPU module and a personal computer.
- If the following conditions are met, the direct connection communication may be disabled. If the communication is disabled, review the settings of the CPU module and personal computer.

Ex.

When all the bits of the CPU module-side IP address that correspond to 0 part of the personal computer-side subnet mask are ON or OFF:

CPU module-side IP address: 64.64.255.255

Personal computer-side IP address: 64.64.1.1

Personal computer-side subnet mask: 255.255.0.0

Ex.

In the CPU module IP address bits, if the bits corresponding to the host address of the class of the personal computer IP address are all ON or all OFF:

Personal computer IP address: 192.168.0.1 ← 192.x.x.x., class C and the host address is the fourth octet.

Personal computer subnet mask: 255.0.0.0

CPU module IP address: 64.64.255.255 ← each bit turns on because of the fourth octet is 255

Point

The IP address for each class is as follows.

- Class A: 0.x.x.x to 127.x.x.x
- Class B: 128.x.x.x to 191.x.x.x
- Class C: 192.x.x.x to 223.x.x.x

The host address for each class is the portion including "0" as shown below.

- Class A: 255.0.0.0
- Class B: 255.255.0.0
- Class C: 255.255.255.0

Screen configuration

Entire screen

The entire screen configuration is shown below.

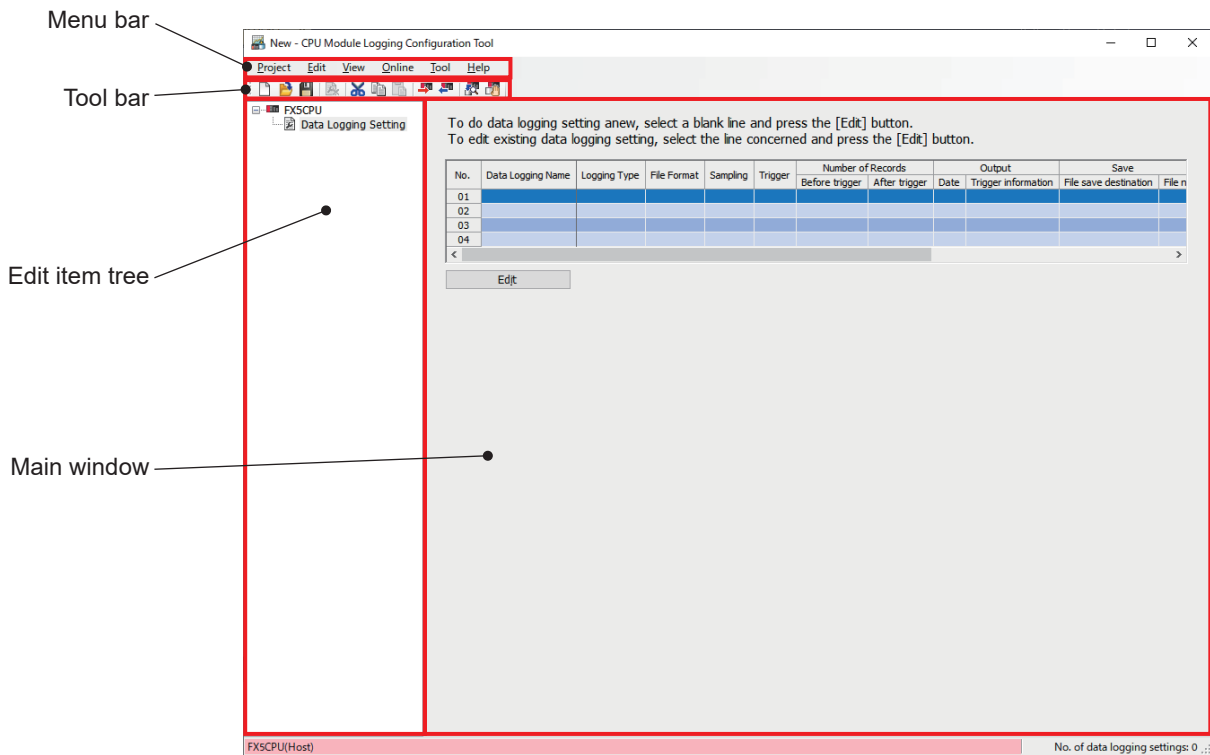

Name	Description	Reference
Menu bar	The menu is displayed.	Page 543 Menu structure
Tool bar	The tool icons are displayed.	—
Edit item tree	The setting items are displayed in tree format.	—
Main window	Set the items necessary for using the data logging function in the wizard window.	Page 555 Setting data logging

Menu structure

The following table describes the menu structure of CPU Module Logging Configuration Tool.

Menu item		Description	Reference
Project	New	Create a new project.	Page 544
	Open	Open a stored project file.	Page 544
	Save	Overwrite an edited project to the file and saves it.	Page 544
	Save As	Save an edited project with a new file name.	Page 544
	Read Logging Setting from Memory Card (SD)	Read the data logging setting written in the SD memory card attached to the personal computer.	Page 545
	Write Logging Setting into Memory Card (SD)	Write the settings being edited in a format with which the CPU module can operate. The settings are directly written into an SD memory card attached to the personal computer.	Page 546
	Recent Files	Open a recently used file.	—
	Exit	Exit CPU Module Logging Configuration Tool.	—
Edit	Delete Data Logging Setting	Remove the data logging setting selected in the Edit item tree.	—
	Copy and Add Data Logging Setting	Copy and add the data logging setting selected in the Edit item tree.	—
	Batch Data Insertion	Configure the multiple setting items at once.	—
	Cut Setting Item	Delete the data in the selected row and copy the setting items to the clip board ^{*1} .	—
	Copy Setting Item	Copy the setting items in the selected row to the clip board. ^{*1}	—
	Paste Setting Item	Paste the copied setting items to the selected row. ^{*2}	—
	Insert and Paste Setting Items ^{*3}	If “Insert and Paste Setting Items” is executed in the state where the setting items are copied/cut, the setting items in the clip board will be inserted above the selected row. ^{*2}	—
	Delete Setting Item	Delete the setting items in the selected row.	—
	Move Setting Item Upward	Move the setting items in the selected row upward.	—
	Move Setting Item Downward	Move the setting items in the selected row downward.	—
	Device Batch Replacement	Replace devices for all the settings.	—
View	Switch Display Language (Display Language)	Change the display language for menus and so on.	Page 547
Online	Transfer Setup	Configure the communication setting used for connection to the CPU module.	Page 547
	Read Logging Setting	Read the setting from the CPU module.	Page 548
	Write Logging Setting	Write the setting to the CPU module.	Page 549
	Delete Logging Setting	Remove the setting data from the CPU module.	Page 550
	Logging Status and Operation	Check the data logging status.	Page 551
	Logging File Operation	Connect to the CPU module and reads or removes the files on the attached SD memory card.	Page 553
Tool	Start GX LogViewer	Launch GX LogViewer.	Page 540
Help	Open Manual	E-Manual Viewer opens and its manual is displayed.	Page 554
	Connection to MITSUBISHI ELECTRIC FA Global Website	The Mitsubishi Electric Corporation FA website is displayed.	Page 554
	About Configuration tool	The product information is displayed.	Page 554

*1 Even if the copied/cut setting items are edited or the screen is switched, the items are still in a copied state. They can be pasted while the copied data is in the clip board.

*2 The setting items copied by using the watch window of GX Works3 or GX Works2, spreadsheet software or text editor can be pasted.

*3 “Insert Copied Setting Item” and “Insert Cut Setting Item” were changed to “Insert and Paste Setting Items”. The version of the CPU Module Logging Configuration Tool with the updated menu is 1.118X.



Project management

This function creates and saves the project, and reads/writes it from/to an SD memory card.

■New

Create a new project.

 [Project] ⇒ [New]

Window

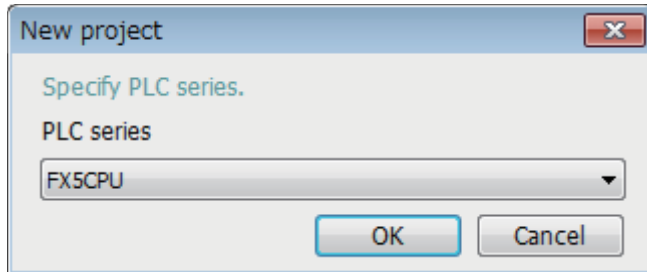

Displayed items

Item	Description
PLC series	Select "FX5CPU".

■Open

Open a stored project file.

 [Project] ⇒ [Open]

■Save

Overwrite an edited project to the file and saves it.

 [Project] ⇒ [Save]

■Save as

Save an edited project with a new file name.

 [Project] ⇒ [Save as]

■Read logging setting from memory card(SD)

The following procedure is to read the data logging setting written in an SD memory card attached to the personal computer.

Operating procedure

1. Attach an SD memory card to the personal computer.
2. Open the following window.
 [Project] ⇒ [Read Logging Setting from Memory Card(SD)]
3. Select the drive from which data is read and data to be read.
4. Click the [Read] button.

Window

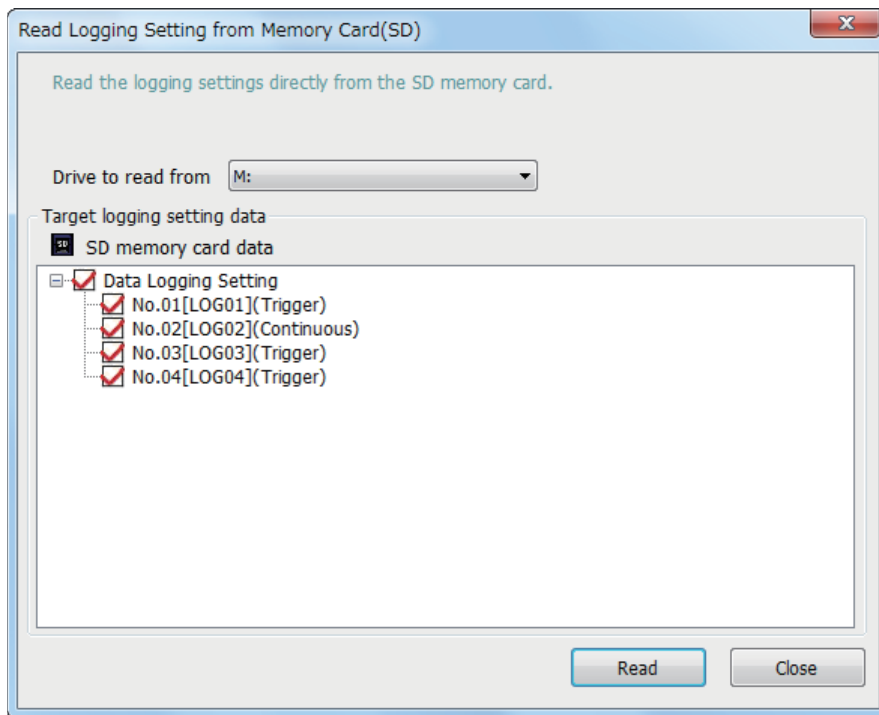

A

Displayed items

Item	Description
Drive to read from	Select the drive where the data to be read is stored.
Target logging setting data	Select the data item to be read.

Point

Any existing data (data logging setting with the same setting number) on the target is overwritten.

Write logging setting into memory card(SD)

The following procedure is to write the settings being edited in a format with which the CPU module can operate. Once writing the settings directly into an SD memory card attached to the personal computer and attaching the card to the CPU module, the data logging starts.

Operating procedure

1. Attach an SD memory card to the personal computer.
2. Open the following window.
 [Project] ⇒ [Write Logging Setting into Memory Card(SD)]
3. Select the drive to which data is written and data to be written.
4. Click the [Write] button.

Window

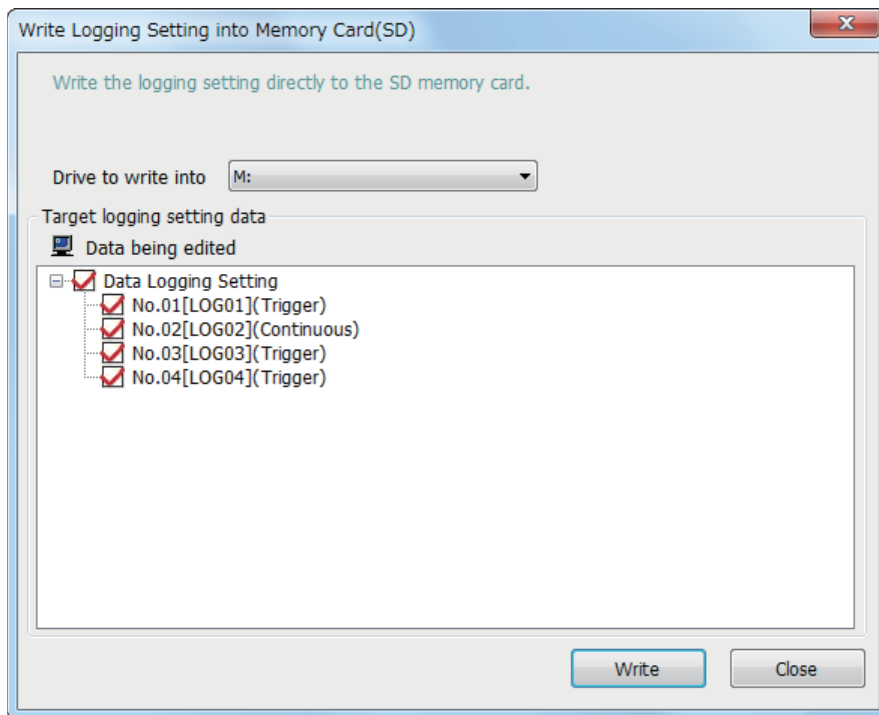

Displayed items

Item	Description
Drive to write into	Select the drive where the data to be written is stored.
Target logging setting data	Select the data to be written.

Point

Any existing data (data logging setting with the same setting number) on the target is overwritten.

View

■Display language change

The CPU Module Logging Configuration Tool supports multiple languages, and can be used by changing the display language for menus and so on at the same computer.

Operating procedure

[View] ⇒ [Switch Display Language (Display Language)]

Precautions

Text may be cut off if the OS and set display language differ.

Online

The online operation enables users to read/write/remove the data logging settings, view the data logging status, and operate the data logging file.

■Transfer setup

The following window specifies the communication route between the CPU module and a personal computer.

 [Online] ⇒ [Transfer Setup]

Window

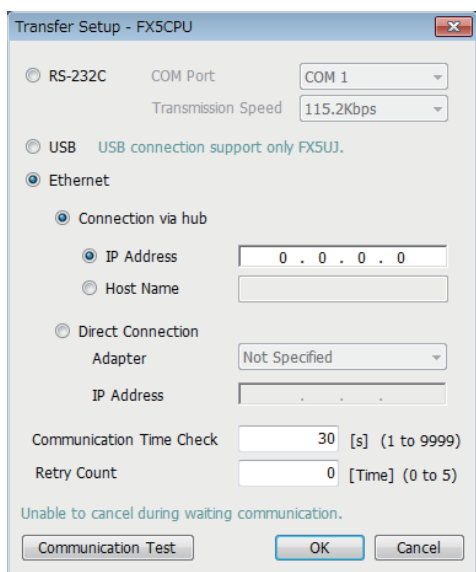

Displayed items

Item	Description		
RS-232C	COM Port	Configure the COM port and transmission speed used for connection with an RS-232C communication cable. • COM Port: COM1 to COM63 • Transmission Speed: 9.6kbps / 19.2kbps / 38.4kbps / 57.6kbps / 115.2kbps	
	Transmission Speed		
USB*1	Configure when connecting with a USB cable.		
Ethernet	Connection via hub	IP Address	Configure the IP address and host name used for connection via a hub with an Ethernet cable.
		Host Name	
	Direct Connection	Adapter	For direct connection with the Ethernet cable, select the Ethernet adapter that is connected directly to the CPU module. The IP address of the selected Ethernet adapter is displayed as the IP address.
		IP Address	
Communication Time Check		Specify the communication time.	
Retry Count		Specify the number of retries.	
[Communication Test] button		This button checks the communication status.	

*1 Only FX5UJ CPU module is supported.



■Read logging setting

The following procedure reads the data logging setting from the target memory.

Operating procedure

1. Open the "Read Logging Setting" window.

 [Online] ⇒ [Read Logging Setting]

2. Select the memory where the data to be read is stored from the "Target memory" list.
3. Select the checkbox corresponding to the data item to be read in the "Target logging setting data" list, and click the [Read] button.

Window

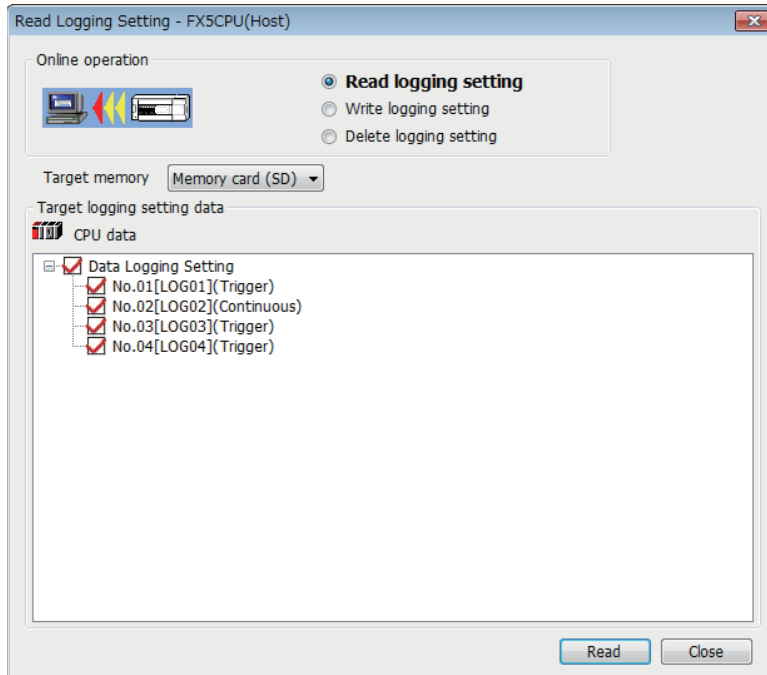

Displayed items

Item	Description
Target memory	Select the memory where the data to be read is stored.
Target logging setting data	Select the data item to be read.

Point

Any existing data (data logging setting with the same setting number or common setting) on the target is overwritten.

Write logging setting

The following procedure is to write the data logging setting to the target memory.

Operating procedure

1. Open the "Write Logging Setting" window.

 [Online] ⇒ [Write Logging Setting]

2. Select the memory where the data to be written is stored from "Target memory" list.
3. Select the checkbox in the "Target logging setting data" list corresponding to the data item to be written, and click the [Write] button.

Setting data

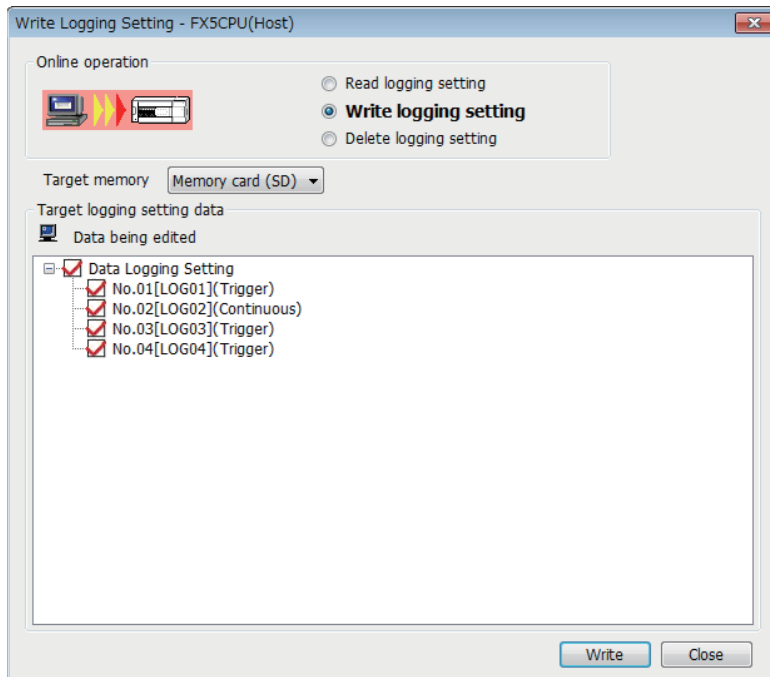

A

Displayed items

Item	Description
Target memory	Select the memory where the data to be written is stored.
Target logging setting data	Select the data to be written.

Point

Any existing data (data logging setting with the same setting number or common setting) on the target is overwritten.

■Delete logging setting

The following procedure removes the data logging setting on the target memory.

Operating procedure

1. Open the "Delete Logging Setting" window.

 [Online] ⇒ [Delete Logging Setting]

2. Select the memory where the data to be removed is stored from the "Target memory" list.

3. Select the checkbox corresponding to the data item to be removed in the "Target logging setting data" list, and click the [Delete] button.

Window

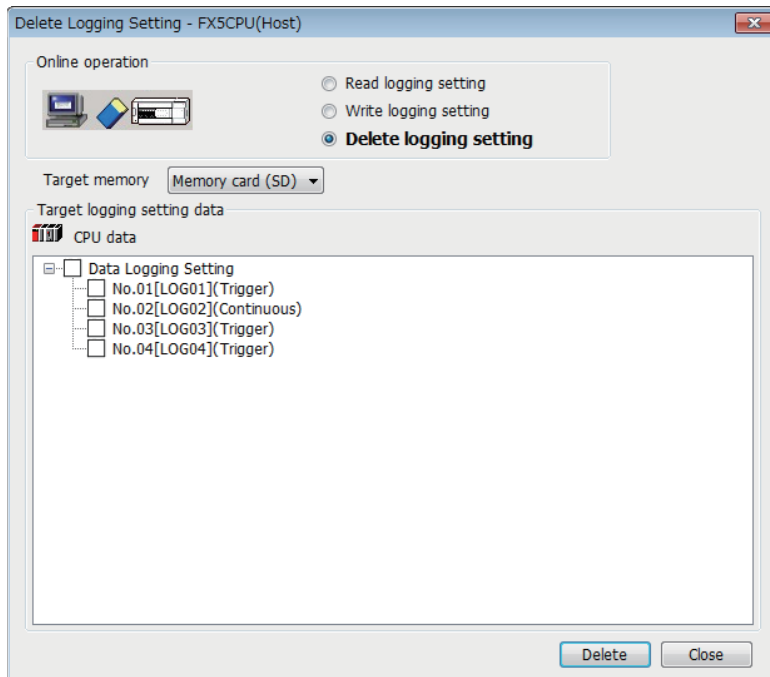

Displayed items

Item	Description
Target memory	Select the memory where the data to be removed is stored.
Target logging setting data	Select the data to be removed.

■ Logging status and operation

The following procedure is to execute or stop the data logging. Also the data logging status can be checked through this procedure.

Operating procedure

1. Open the "Logging Status and Operation" window.
🖱️ [Online] ⇒ [Logging Status and Operation]
2. Specify the target memory (either data memory or SD memory card) where the effective setting data is stored.
3. Select the checkbox corresponding to the setting number to be executed (One or more numbers can be selected).
4. Start the data logging by clicking the [Start] button (when multiple items are selected, they are executed simultaneously).
5. To suspend the data logging, click the [Pause] button, and to stop the data logging, click the [Stop] button (when multiple items are selected, they are executed simultaneously).

Point

- The data logging cannot be started even when writing the setting and turning power off and on or resetting. Be sure to click the [Start] button to start the data logging.
- With regards to the trigger logging, the data logging setting registration attempt fails if the trigger condition is satisfied.
- It takes a certain time to stop or suspend the data logging after either of these commands is issued by CPU Module Logging Configuration Tool (because the data logging is not stopped or suspended unless the data stored in the internal buffer data has been transferred into the SD memory card in response to these commands).
- There may be a case where a time-out error occurs and the data logging is suspended after CPU Module Logging Configuration Tool starts the logging.

Window

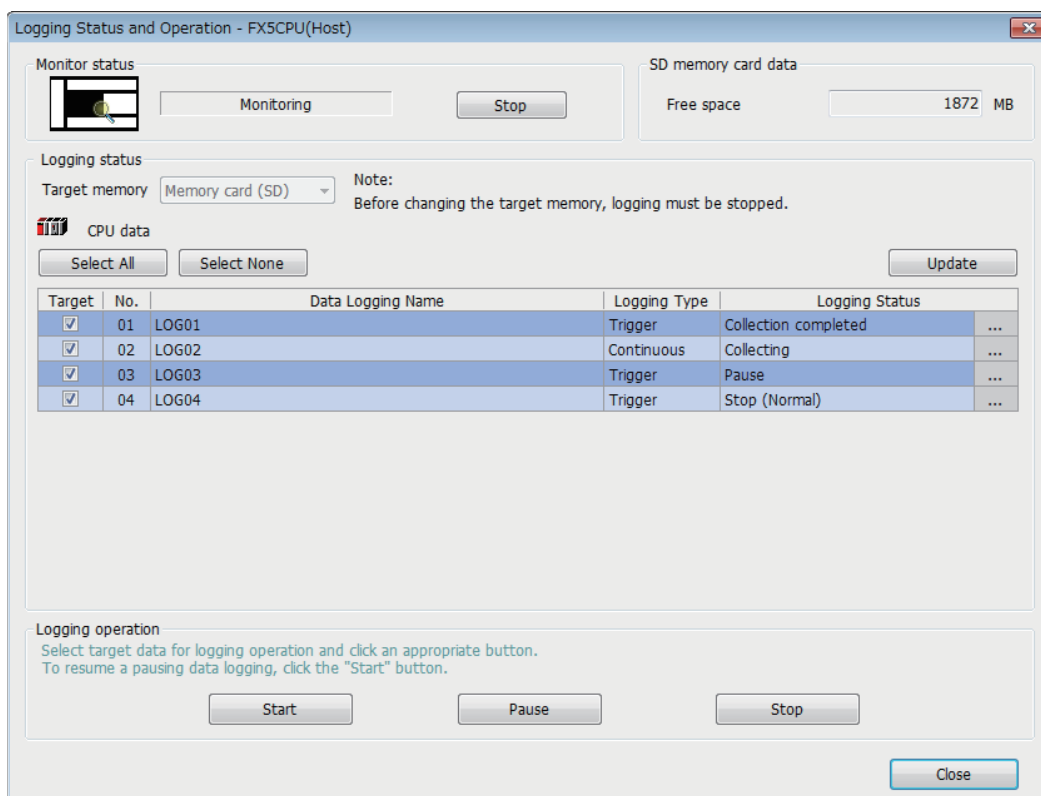

Displayed items

Item		Description
Monitor status	[Start (Stop)] button	Start or stop monitoring.
SD memory card data	Free space	View the amount of free space of the SD memory card.
Logging status	Target memory	Select the memory used for this operation.* ¹
	[Select All] button	Select all the checkboxes in the setting data list.
	[Select None] button	Clear all the checkboxes in the setting data list.
	[Update] button	Update monitoring status.
	Target	Select the target setting data for this operation (one or more numbers can be selected).
	[...] button	Clicking this button when an error occurs displays the error details window.
Logging operation	[Start] button	Execute the logging of the selected setting data.
	[Pause] button	Suspend the logging of the selected setting data.
	[Stop] button	Stop the logging of the selected setting data.

*¹ This menu item can be selected only when all the data logging statuses are "Stop."

The data logging function has various states that can be classified into data logging and storage.

• Data logging states

Data logging states	Description
Stop	No data logging settings are registered and data collection is inactive.
Waiting RUN Not collected	Data collection has not yet begun because the CPU module is not in the RUN mode.
Waiting start Not collected	Data collection has not yet begun because waiting for the start command.
Pause	Data logging is suspended and data collection is inactive.
Waiting to establish collection conditions Not collected	Waiting for the first collection timing after the start command.
Collecting	Continuous logging is active and collecting data.
Waiting trigger Collecting before trigger	Trigger logging is active and collecting data, waiting until the trigger condition is met.
Collecting after trigger	Trigger logging is active and collecting data after the trigger condition is met.
Collection completed	<ul style="list-style-type: none"> • Continuous logging: Data collection has finished upon reaching "Number of files to be saved" specified as part of the "Stop" setting configured in "Operation when the number of files exceeds the set value." • Trigger logging: Has finished collecting as much data as the specified number of records.
Error	Data logging has failed due to the occurrence of an error.

• Storage states

Storage states	Description
Unsaved	Has not yet stored the collected data into the SD memory card.
Saving in progress	Has begun but not yet finished storing the collected data into the SD memory card.
Save completed	Has finished storing the collected data as much as the specified number of records into the SD memory card.* ¹

*¹ If the data logging function has not yet collected and stored as much data as the specified number of records (i.e., either data logging has been stopped or suspended before collecting or storing as the specified number of records or the CPU module has been stopped), it completes the storage operation by storing all the data that has been collected into the internal buffer. It does not store data, however, before the trigger condition is met.

■ Logging file operation

The following procedure is to save or remove data logging files on an SD memory card from/to the personal computer.

Operating procedure

1. Open the "Logging File Operation" window.
🔗 [Online] ⇨ [Logging File Operation]
2. Specify the directory and select the targeted file.
3. To save click the [Save to PC] button, and to remove click the [Delete] button.

Point

Attempting the following operations may result in delay of other monitor update because a certain time period is required for saving data logging files.

- When saving data logging files during the data logging execution.
- When saving a large data logging file.

Window

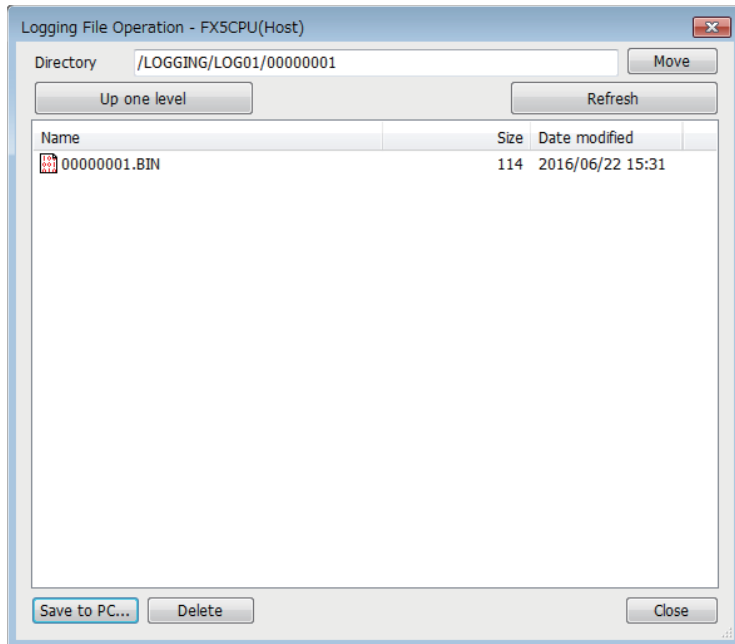

A

Displayed items

Item	Description
Directory	View the path to the displayed folder. To change the folder, specify the target folder path.
[Move] button	Move to the specified folder.
[Up one level] button	Move up to a higher level in the folder hierarchy.
[Refresh] button	Update the displayed content.
[Save to PC] button	Display the "Save As" window and save the selected file to the personal computer.
[Delete] button	Remove the selected file or folder.

Help

The following procedures allow to view or use the help function of CPU Module Logging Configuration Tool.

■Opening user's manual

E-Manual Viewer opens and its manual is displayed.

Operating procedure

 [Help] ⇒ [Open Manual]

■Connection to MITSUBISHI ELECTRIC FA Global Website

Access Mitsubishi Electric Corporation FA site home page.

Operating procedure

 [Help] ⇒ [Connection to MITSUBISHI ELECTRIC FA Global Website]

■Checking version information

Check the version of CPU Module Logging Configuration Tool.

Operating procedure



 [Help] ⇒ [Version Information]

Setting data logging

This menu item launches a wizard that helps users to configure the required settings for using the data logging function.

 Edit item tree ⇒ [FX5CPU] ⇒ [Data Logging Setting] ⇒ [Edit] button

Logging type

The following window configures the data logging type ( Page 146 Logging type,  Page 153 Data output specifications)

Window

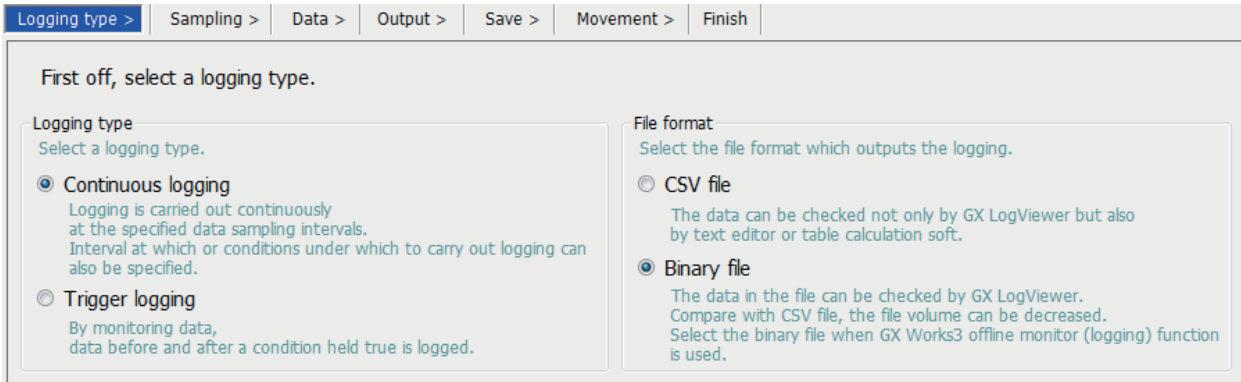

Displayed items

Item	Description	Setting range	Default
Logging type	Select the logging type.	<ul style="list-style-type: none"> Continuous logging Trigger logging 	Continuous logging
File format	Select the output file format. ( Page 153 Data logging file)	<ul style="list-style-type: none"> CSV file^{*1} Binary file 	Binary file

*1 Only FX5U/FX5UC CPU module is supported.



Collection

The following window configures the collection interval and/or collection start conditions (☞ Page 148 Data collection conditions)

Window

Logging type > **Sampling** > Data > Output > Save > Movement > Finish

Specify the sampling interval and start conditions.

Sampling interval

Each scanning cycle
Samples data at each sequence scanning cycle.

Time specification [ms] (10-32767) ▾
Samples data at the specified time interval.

Condition specification
Specifies data sampling timing by device data conditions.

Device	Conditional formula	Radix	Value
<input type="text"/>	<input type="text"/>	<input type="text"/>	<input type="text"/>

Data type(K)

Displayed items

Item	Description	Setting range	Default
Each scanning cycle	Select this item to collect scan data obtained for each scan operation.	—	—
Time specification	Select this checkbox to collect data at a timing when the first END processing is done after the specified time interval is elapsed.	<ul style="list-style-type: none"> ms: 10 to 32767 s: 1 to 86400 	10 ms
Condition specification	Specify the data collection timing according to the device data conditions.	☞ Page 149 Condition specification	—

Data

The following window configures the various items such as data format of the target collection device.

Window

Logging type > Sampling > **Data** > Output > Save > Movement > Finish

Set the data for logging.

A total of up to 128 device points can be set.
Bit digit specification is using points corresponding to data type. (1 point for word type and 2 points for double-word type)

No.	Device		Data Type	Size [Byte]	Output Format
	Head	Last			
001			▾		...
002			▾		...
003			▾		...
004			▾		...
005			▾		...

Displayed items

Item	Description	Setting range	Default
No.	In this column, the data setting numbers from 001 to 128 are displayed.	—	—
Device	Head	☞ Page 151 Data to be collected	
	Last		
Data Type	Select the type of target data.	☞ Page 151 Data type	
Size [Byte]	Specify the data size when the data type is set to "String" or "Raw".	1 to 256 bytes	
Output Format	Clicking the [...] button at the rightmost part of each row displays the "Output Format (integer.float)" list. Select the format to be used when data is output to the file.	☞ Page 153 Data output specifications	

Batch insertion of data

The following window is to insert data items into the data list at once. Data is inserted into blank rows in the list of the "Data" setting window in order from the top (when a setting already exists in the target insertion row, the row is skipped without overwriting it).

Operating procedure

1. Open the following window.
 [Edit] ⇒ [Batch Data Insertion]
2. Configure the setting items and continuous settings, and click the [OK] button.

Window

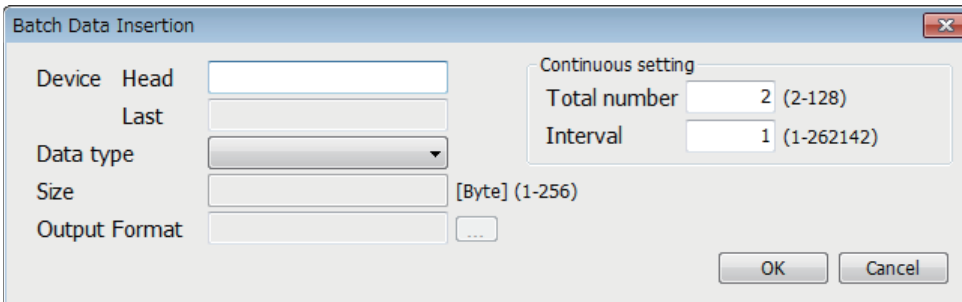



Displayed items

Item	Description	Setting range	Default
Device	Head	Same as the data setting (☞ Page 556 Data)	—
	Last		
	Data type		
	Size		
	Output Format		
Continuous setting	Total number	2 to 128	2
	Interval	1 to 262142	1

Trigger

The following window specifies the trigger condition when the trigger logging is selected ( Page 152 Trigger condition)

Window

Logging type > | Sampling > | Data > | **Trigger >** | Number of logging lines > | Output > | Save > | Movement >  

Make trigger setting.

Condition specification
Sets trigger condition with device data values.

Device Conditional formula Radix Value

Data type(K)

When trigger instruction executed
Trigger conditions met when LOGTRG instruction is executed.



Displayed items

Item	Description	Setting range	Default
Condition specification	Configure the trigger condition based on the device data condition.	 Page 152 Condition specification	Checked
When trigger instruction executed	Trigger condition is established when the LOGTRG instruction is executed.	—	—

Number of records

The following window specifies the number of records to be output before and after trigger occurrences when the trigger logging is selected ( Page 147 Number of records)

Window

Logging type > | Sampling > | Data > | Trigger > | **Number of logging lines >** | Output > | Save > | Movement >  

Data before and after trigger condition rises will be logged.
Specify the numbers of records before and after trigger.

No. of records (before trigger) [Record] (0-99999)

No. of records (after trigger) [Record] (1-100000)

Total No. of records [Record] (1-100000)

Displayed items

Item	Description	Setting range	Default
No. of records (before trigger)	Specify the number of records to be output as pre-trigger record.	0 to 99999	1
No. of records (after trigger)	Specify the number of records to be logged during and after a trigger occurrence.	1 to 100000	1
Total No. of records	View the total number of pre-trigger and post-trigger records.	—	2

Output

The following window specifies the items to be output into the file. (Page 153 Data output specifications)

Window

Displayed items

Item	Description	Setting range	Default
Date	Output date	*3*4	Checked (YYYY/MM/DD hh:mm:ss.sss)
	Set Date Line Format		
Trigger information	Output trigger information	256 characters or less	— (*)
	Set String for Trigger		
Index	Output index	—	Checked
Data sampling interval	Output data sampling interval		
Comment	Output comments		
	Comment*6	256 characters or less (No line feed can be used.)	LOG [Logging setting No.]

*1 Only CSV file is supported for the file format.

*2 Only FX5U/FX5UC CPU module is supported.

*3 Data output format can be created by combining the following formats.

- Year: YYYY for four-digit expression; YY for two-digit expression
- Month: MM
- Day: DD
- Hour: hh
- Minute: mm
- Second: ss

· Millisecond: ms (three-digit expression), or s, ss, sss, ssss, ssssss, or sssssss (second unit after the decimal point, maximum of seven digits)

Example: YYYY/MM/DD hh:mm:ss.sss → 2016/10/13 09:44:35.241

*4 When either of "Year", "Month", "Day", "Hour", "Minute", or "Second" is omitted, if opening the data logging file by GX LogViewer, the index expression is used rather than the time expression.

GX LogViewer Version 1 Operating Manual

*5 If characters other than a single-byte character are used, the scan time can be long when the logging is started.

*6 You can use any characters as long as Unicode can describe them. Note, however, that you cannot use ["] (double quotation), [,] (comma) or [;] (semi colon).

Save

The following window configures the target storage for data logging file and switching timing of storage files. (Page 161 Switching to a storage file)

Window

Displayed items

Item	Description		Setting range	Default	
Logging file save setting	File save destination		Specify the storage folder for the data logging file.	60 characters or less (double-byte character not allowed)	
	Folder to store file to be saved		Select information to be added to the name of the folder which stores the storage file.	—	
	File name	Simple setting	Specify information to be added to the name of the storage file (the name of the storage folder, date, time) by the [Simply set additional information] button.	—	Checked
		Optional setting	Specify the format of information to be added to the name of the storage file (the name of the storage folder, date, time) by the [Optionally set additional information] button. The device data value can be added.*3	*1*2	—
	Add date type	Add date/time when the file switching condition is satisfied and when the file is created if the simple setting or optional setting is selected.	—	—	
File switching setting	Number of files to be saved	Number of files to be saved	Specify the maximum number of storage files.	1 to 65535	1
		Operation when exceeds the number of files	Select the operation when the number of files exceeds the maximum number of files to be saved. (Page 163 Action to take when the maximum number of storage files is exceeded)	<ul style="list-style-type: none"> Overwrite Stop 	Overwrite
	File switch timing*4		Select the timing at which the file is replaced with new one (Page 162 File switching condition)	<ul style="list-style-type: none"> Number of records: 1 to 65500 File size: 10 to 16384K bytes Condition specification 	Number of records (1000)

- *1 Date and/or time can be added in any format by using the following character strings.
 - Year: YYYY for four-digit expression; YY for two-digit expression
 - Month: MM
 - Day: DD
 - Day of the week: ddd (Sunday: Sun, Monday: Mon, Tuesday: Tue, Wednesday: Wed, Thursday: Thu, Friday: Fri, Saturday: Sat)
 - Hour: hh
 - Minute: mm
 - Second: ss
 Example: for June 18, 2014 (Wednesday), 09:30:15, YYYYMMDDdddhhmmss → 20140618Wed093015_00000001.BIN
 Also when using the additional information simply as a character string rather than the above format, any character string can be added by enclosing it with double-quotation marks (" ").
 Example: when adding the character string "address" to the file name, "address" → address_00000001.BIN can be used.
- *2 Maximum of 64 characters (including underscore (_), serial number (eight digits), period, and extension) can be used. However, when specifying a character string that contains double quotation marks (" "), the maximum number reduces by the number of the double quotation marks.
- *3 When the device data is used for the saved file name, it is recommended that the latch device is used because the saved file may be created after the PLC stops.
- *4 Reducing the setting value results in frequent file switching, so that it is possible that the scan time and/or the device processing time can be extended.

Logging operation

The following window specifies the data logging operation when the mode transfers to RUN mode (☞ Page 165 Setting the operation at the time of transition to RUN)

Window

A

Displayed items

Item	Description	Setting range	Default
Operation at transition to RUN	Select the operation when the mode transfers to RUN mode.	<ul style="list-style-type: none"> • Auto Start • Start by User Operation 	Auto Start

Finish

The following window is to give the data logging setting a name.

Window

Logging type > | Sampling > | Data > | Output > | Save > | Movement > | **Finish**

All data required for data logging have been collected.
Press the "Complete" button to complete setting.

To reflect the settings to the PLC, select [Online]->[Write Logging Setting].

Name the data logging.

Data logging name

Free space volume below in SD memory card will be necessary to execute logging of the set content.
Larger volume might be necessary depending on status of SD memory card.

Total Size of Output Logging Files [MB]

To execute logging of the settings, the following internal buffer capacity is required.
Please set internal buffer capacity as needed.

Required Internal Buffer Capacity in Logging [KB]

The internal buffer capacity can be set in
'Parameter->Control CPU->CPU Parameter->Memory/Device Setting->Internal Buffer Volume Setting' of GX Works3.
Default value: 80[KB]

Displayed items

Item	Description	Setting range	Default
Data logging name*1	Give the data logging setting being configured a name.	32 characters or less	LOG [Logging setting No.]
Total Size of Output Logging Files	View the total capacity of the data logging file which is output based on the specified settings. The total capacity can be increased/decreased by adding/removing the items to be output to the file.	—	1
Required Internal Buffer Capacity in Logging	View the internal buffer capacity required to execute the data logging based on the specified settings. This value can be specified with the internal buffer capacity setting of engineering tool (Page 128 INTERNAL BUFFER CAPACITY SETTING)	—	1

- *1 When the following user action is detected, character entry will be disabled
- Entered a character which cannot be handled by the OS language character code.
 - Entered a character whose language code is different from the one for characters already input in the same data logging setting.

Supported characters

This section describes the supported characters.

■Supported characters for CPU Module Logging Configuration Tool

Any characters that can be expressed by Unicode are supported. However, the supported characters vary for each position as shown in the following table. Note that if attempting to input an unsupported character, the entry is rejected or a message window appears in response to the improper entry.

Place where character is used		Support status of the target character																	
		(SP) ^{*1}	”	'	*	+	?	/	:	;	<	>	?	[?]		.	Two-byte characters
Data Logging Setting	• Data logging name • String for Indicating Trigger Occurrence • Comment	○	×	○	○	○	×	○	○	×	○	○	○	○	○	○	○	○	○
	Date Line Output Format	○	×	○	○	○	×	○	○	×	○	○	○	○	○	○	○	○	×
Logging File Operation	Directory	×	×	○	×	○	×	○	×	×	×	×	○	×	○	×	×	×	

*1 (SP) means a space.



Surrogate pair characters cannot be used.

■Supported characters for file and/or folder (directory) name

Characters in the shaded area can be used.

	0	1	2	3	4	5	6	7	8	9	A	B	C	D	E	F
0	NULL		(SP)	0	@	P	`	p				-	々	ミ		
1			!	1	A	Q	a	q			。	ア	チ	ム		
2			”	2	B	R	b	r			「	イ	ツ	メ		
3			#	3	C	S	c	s			」	ウ	テ	モ		
4			\$	4	D	T	d	t				エ	ト	ヤ		
5			%	5	E	U	e	u			,	オ	ナ	ユ		
6			&	6	F	V	f	v			.	カ	ニ	ヨ		
7			'	7	G	W	g	w			ヲ	キ	ヌ	ヲ		
8			(8	H	X	h	x			ァ	ク	ネ	リ		
9)	9	I	Y	i	y			イ	ケ	ノ	ル		
A			*	:	J	Z	j	z			ウ	コ	ハ	レ		
B			+	;	K	[k	{			エ	サ	ヒ	口		
C			,	<	L	¥	l				ヤ	シ	フ	フ		
D			-	=	M]	m	}			ユ	ス	ハ	ソ		
E			.	>	N	^	n	~			ヨ	セ	ホ	ニ		
F			/	?	O	_	o				ツ	ソ	マ	。		

A

Procedure for installing the built-in USB driver of FX5UJ CPU module

To communicate with the FX5UJ CPU module via USB, a USB driver needs to be installed. This section describes the installation procedure of a USB driver. If multiple MELSOFT products are installed, refer to their installed location.

■Windows® XP

Operating procedure

1. Connect a personal computer to the CPU module with a USB cable, and power on the CPU module.
2. Select "Install from a list or specific location (Advanced)" on the "Found New Hardware Wizard" window.
3. On the next window, select "Search for the best driver in these locations". Check the "Include this location in the search" checkbox, and specify the "Easysocket\USBDrivers" folder where the CPU Module Logging Configuration Tool has been installed.

Precautions

If the driver cannot be installed, check the following setting on Windows®.

Select [Control Panel] ⇒ [System] ⇒ [Hardware], and click the [Driver Signing] button. If "Block - Never install unsigned driver software" is selected, the USB driver may not be installed. Select "Ignore - Install the software anyway and don't ask for my approval" or "Warn - Prompt me each time to choose an action", and then install the USB driver.

■Windows Vista®

Operating procedure

1. Connect a personal computer to the CPU module with a USB cable, and power on the CPU module.
2. Select "Locate and install driver software (recommended)" on the "Found New Hardware" window.
3. On the next window, select "Browse my computer for driver software (advanced)".
4. On the next window, select "Search for the best driver in these locations". Check the "Include subfolders" checkbox, and specify the "Easysocket\USBDrivers" folder where the CPU Module Logging Configuration Tool has been installed.

Precautions

If "Windows can't verify the publisher of this driver software" appears on the "Windows Security" window, select "Install this driver software anyway".

■Windows® 7 and later

Operating procedure

1. Connect a personal computer to the CPU module with a USB cable, and power on the CPU module.
2. Select [Start] ⇒ [Control Panel] ⇒ [System and Security] ⇒ [Administrative Tools] ⇒ [Computer Management] ⇒ [Device Manager]. Right-click "Unknown device", and click "Update Driver Software".
3. On the "Update Driver Software" window, select "Browse my computer for driver software" and specify the "Easysocket\USBDrivers" folder where the CPU Module Logging Configuration Tool has been installed on the next window.

Appendix 8 Substitute Functions

File registers

To use a file register of the FX3 PLC, use functions of the FX5 PLC.

A file register is a device that sets an initial value to a data register that has the same device number. The values of the file registers set in the built-in memory or memory cassette is transferred collectively to the data registers when the power of the FX3 PLC is OFF→ON or the PLC is STOP→RUN.

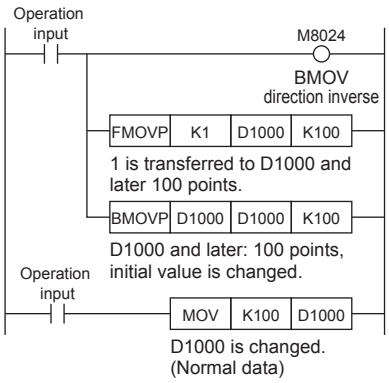
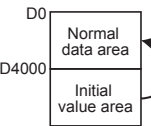
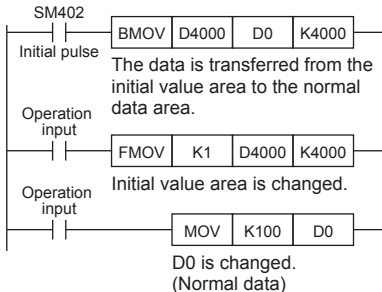
File registers function of FX3 PLC	Substitute function of FX5 PLC	Reference
<ul style="list-style-type: none"> The initial value setting of the data register When the power OFF→ON or the PLC is STOP→RUN, the data register is initialized. 	<p>The setting is possible with the device initial value setting. If the initial value is set, the data register is initialized when the power is OFF→ON, reset or the PLC is STOP→RUN.</p>	Page 130
<p>The initial value of the data register (FX3 file register) can be changed by the BMOV instruction. When changed by something other than the BMOV instruction, it is treated as a normal data register. When the power is OFF→ON or the PLC is STOP→RUN, the value that is changed by the BMOV instruction is the initial value.</p> <p>■Program example When D1000 and later are used as FX3 file registers</p>  <p>When the above program is executed, the value of D1000 becomes 100. When the PLC is stopped and restarted, the initial value "1" specified by the BMOV instruction is stored in D1000 to D1099.</p>	<p>Divide data register area into initial value area and normal data area. When the PLC is STOP→RUN, transfer the data in the initial value area to the normal data area to use the initial value area as file registers. Use the latch function in the initial value area.</p> <p>■Data register area and program example When D4000 and later are the initial value area</p> <p>Data register area</p>   <p>When the above program is executed, the value of D0 becomes 100. When the PLC is stopped and restarted, the initial value "1" that is stored in the initial value area, D4000 to D7999, is transferred to the normal data area, D0 to D3999.</p>	Page 132



Appendix 9 Added and Enhanced Functions

The firmware version can be confirmed with module diagnosis (CPU diagnosis). Refer to the following manuals for details on diagnosing the module (CPU diagnosis).

📖 MELSEC iQ-F FX5UJ User's Manual (Hardware)

📖 MELSEC iQ-F FX5U User's Manual (Hardware)

📖 MELSEC iQ-F FX5UC User's Manual (Hardware)

Refer to the 📖 GX Works3 Operating Manual for details on the software version.

FX5UJ CPU module

Add/Change Function	Supported CPU module firmware version	Supported engineering tool software version	Reference
FX5UJ CPU module is supported.	From the first	"1.060N" and above	—
The following modules are supported. • FX5-SF-MU4T5 • FX5-SF-8DI4	"1.010" and above	"1.075D" and above	MELSEC iQ-F FX5 User's Manual (Safety Control)
The following modules are supported. • FX5-4A-ADP	"1.010" and above	"1.075D" and above	MELSEC iQ-F FX5 User's Manual (Analog Control - CPU module built-in, Expansion adapter)

FX5U/FX5UC CPU module

Add/Change Function	Supported CPU module firmware version	Supported engineering tool software version	Reference
The number of settable high-speed comparison tables was changed from maximum 4 to 32.	"1.015" and above*1	"1.015R" and above	Page 244
The number of high-speed comparisons was changed from 4 to 32.	"1.015" and above*1	"1.015R" and above	Page 287
The following modules are supported. • FX5-16ET/ES-H • FX5-16ET/ESS-H	"1.030" and above	"1.025B" and above	Page 220 MELSEC iQ-F FX5 User's Manual (Positioning Control - CPU module built-in, High-speed pulse input/output module)
Firmware update function	From the first version*2	—*3	Page 53
Data logging function	"1.040" and above*4	"1.64S" or later*5	Page 144
Event history function	"1.040" and above*6	"1.030G" and above	Page 194
Internal buffer capacity setting	"1.040" and above*4	"1.030G" and above	Page 128
PID control operation setting (ACT) • Overshoot suppression setting • Hunting suppression setting	"1.040" and above	"1.030G" and above	Page 77
The following modules are supported. • FX5-4AD-PT-ADP • FX5-4AD-TC-ADP	"1.040" and above	"1.030G" and above	MELSEC iQ-F FX5 User's Manual (Analog Control - CPU module built-in, Expansion adapter)
File transfer function (FTP server)	"1.040" and above*4*7	"1.030G" and above	MELSEC iQ-F FX5 User's Manual (Ethernet Communication)
iQ Sensor Solution • Automatic detection of connected devices • Communication setting reflection of Ethernet device • Sensor parameter read/write	"1.040" and above	"1.030G" and above	iQ Sensor Solution Reference Manual
CC-Link IE Field Network Basic function	"1.040" and above	"1.030G" and above	CC-Link IE Field Network Basic Reference Manual
Data backup/restoration function	"1.045" and above*8	—	Page 199
Memory dump function	"1.050" and above*4	"1.035M" and above	Page 179
IP filter function	"1.050" and above	"1.035M" and above	MELSEC iQ-F FX5 User's Manual (Ethernet Communication)

Add/Change Function	Supported CPU module firmware version	Supported engineering tool software version	Reference
Parallel link function	"1.050" and above	"1.035M" and above	MELSEC iQ-F FX5 User's Manual (Serial Communication)
The following module is supported. • FX5-CCL-MS	"1.050" and above	"1.035M" and above	MELSEC iQ-F FX5 User's Manual (CC-Link)
The following module is supported. • FX5-20PG-P	"1.050" and above	"1.035M" and above	MELSEC iQ-F FX5 User's Manual (Positioning Control - Intelligent function module)
The following modules are supported. • FX5-8AD	"1.050" and above	"1.035M" and above	MELSEC iQ-F FX5 User's Manual (Analog Control - Intelligent function module)
The following modules are supported. • FX5-4LC	"1.050" and above	"1.035M" and above	MELSEC iQ-F FX5 User's Manual (Temperature Control)
The following module is supported. • FX5-ASL-M	"1.050" and above	"1.035M" and above	MELSEC iQ-F FX5 User's Manual (AnywireASLINK)
Real-time monitor function	"1.060" and above	*9	Page 188
Support extended file register function	"1.060" and above*4	"1.040S" and above	Page 364
MODBUS/TCP communication function	"1.060" and above	"1.040S" and above	MELSEC iQ-F FX5 User's Manual (MODBUS Communication)
Time setting function (SNTP client)	"1.060" and above	"1.040S" and above	MELSEC iQ-F FX5 User's Manual (Ethernet Communication)
Web server function	"1.060" and above	"1.040S" and above	MELSEC iQ-F FX5 User's Manual (Ethernet Communication) MELSEC iQ-R/MELSEC iQ-F Web Server Function Guide Book
Support S(P).DEVLD, SP.DEVST, ERREAD, ERWRITE, ERINIT and RTM instruction	"1.060" and above*10	"1.040S" and above	MELSEC iQ-F FX5 Programming Manual (Instructions, Standard Functions/Function Blocks)
Support "Use MC/MCR for control of EN" of the subroutine type FB	"1.060" and above	"1.040S" and above	GX Works3 Operating Manual
The following modules are supported. • FX5-4AD • FX5-4DA	"1.050" and above	"1.040S" and above	MELSEC iQ-F FX5 User's Manual (Analog Control - Intelligent function module)
During IP address duplication with the device on the same network, the operation was improved to output the information of the external device with duplicated IP address.	"1.061" and above	—	MELSEC iQ-F FX5 User's Manual (Ethernet Communication)
Keep of latch label during PC write by SM9353	"1.065" and above	—	Page 136
Expanding the number of input/output points to 384 points.	"1.100" and above	"1.047Z" and above	MELSEC iQ-F FX5U User's Manual (Hardware) MELSEC iQ-F FX5UC User's Manual (Hardware)
Removing the limitation on the number of remote I/O points. (384 points) (However, the total number of remote I/O points and input/output points is 512 points or less.)	"1.100" and above	"1.047Z" and above	MELSEC iQ-F FX5U User's Manual (Hardware) MELSEC iQ-F FX5UC User's Manual (Hardware)
Expanding the program capacity up to 128000 steps.	"1.100" and above	"1.047Z" and above	MELSEC iQ-F FX5U User's Manual (Hardware) MELSEC iQ-F FX5UC User's Manual (Hardware)
Divided writing of the program and program restoration information of online change	"1.100" and above	"1.047Z" and above	Page 73
User Web page is supported.	"1.100" and above	"1.047Z" and above	MELSEC iQ-F FX5 User's Manual (Ethernet Communication) MELSEC iQ-R/MELSEC iQ-F Web Server Function Guide Book



Add/Change Function	Supported CPU module firmware version	Supported engineering tool software version	Reference
The following module is supported. • FX5-20PG-D	"1.050" and above	"1.050C" and above	MELSEC iQ-F FX5 User's Manual (Positioning Control - Intelligent function module)
The following module is supported. • FX5-ENET	"1.110" and above	"1.050C" and above	MELSEC iQ-F FX5-ENET User's Manual
The following module is supported. • FX5-DP-M	"1.110" and above	"1.050C" and above	MELSEC iQ-F FX5 User's Manual (PROFIBUS)
Expanding the number of remote I/O station of CC-Link IE field network Basic from 6 to 16 stations.	"1.110" and above	"1.050C" and above	MELSEC iQ-F FX5U User's Manual (Hardware) MELSEC iQ-F FX5UC User's Manual (Hardware)
1C frame of MC protocol	"1.110" and above	"1.050C" and above	MELSEC iQ-F FX5 User's Manual (MELSEC Communication Protocol) MELSEC iQ-F FX5 User's Manual (Serial Communication)
The following modules support the module diagnostics and event history function. • FX5-20PG-P*11 • FX5-20PG-D*11 • FX5-ENET	"1.110" and above	"1.050C" and above	Page 194
Simple CPU communication function	"1.110" and above	"1.050C" and above	MELSEC iQ-F FX5 User's Manual (Ethernet Communication)
The following modules are supported. • FX5-SF-MU4T5 • FX5-SF-8DI4	"1.200" and above	"1.060N" and above	MELSEC iQ-F FX5 User's Manual (Safety Control)
Down counting for LC0 to LC34 is supported.	"1.201" and above	"1.060N" and above	MELSEC iQ-F FX5 Programming Manual (Instructions, Standard Functions/Function Blocks)
The area capacity in the device/label memory area setting (standard area) increased from 48K to 63K.	"1.210" and above	"1.065T" and above	Page 122
Data logging function supports a CSV file format.	"1.210" and above*12	"1.106K" and above*5	Page 144 Page 540
The following modules are supported. • FX5-CCLGN-MS	"1.210" and above	"1.065T" and above	MELSEC iQ-F FX5 User's Manual (CC-Link IE TSN)
The following modules support the parameter setting function by the program. • FX5-CCL-MS	"1.210" and above	"1.065T" and above	MELSEC iQ-F FX5 User's Manual (CC-Link)
Support 1E frame of SLMP.	"1.210" and above	—	MELSEC iQ-F FX5 User's Manual (Ethernet Communication) MELSEC iQ-F FX5 User's Manual (SLMP)
Support file transfer function (FTP client).	"1.210" and above	"1.065T" and above	MELSEC iQ-F FX5 User's Manual (Ethernet Communication)
Supported models for the simple CPU communication function are added.	"1.210" and above	"1.065T" and above	MELSEC iQ-F FX5 User's Manual (Ethernet Communication)
SFC programs are supported.	"1.220" and above	"1.070Y" and above	MELSEC iQ-F FX5 Programming Manual (Program Design)
Instructions for SFC programs are supported.	"1.220" and above	"1.070Y" and above	MELSEC iQ-F FX5 Programming Manual (Instructions, Standard Functions/Function Blocks)
The following modules are supported. • FX5-40SSC-G • FX5-80SSC-G	"1.230" and above	"1.072A" and above	MELSEC iQ-F FX5 Motion Module/ Simple Motion Module User's Manual (Startup)
Firmware update function using engineering tool.	"1.240" and above	"1.075D" and above	Page 60
File operation instructions is supported.	"1.240" and above	"1.075D" and above	MELSEC iQ-F FX5 Programming Manual (Instructions, Standard Functions/Function Blocks)

Add/Change Function	Supported CPU module firmware version	Supported engineering tool software version	Reference
Unicode string data transfer instruction is supported.	"1.240" and above	"1.075D" and above	MELSEC iQ-F FX5 Programming Manual (Instructions, Standard Functions/Function Blocks)
Unicode character string to Shift JIS character string convert instruction is supported.	"1.240" and above	"1.075D" and above	MELSEC iQ-F FX5 Programming Manual (Instructions, Standard Functions/Function Blocks)
Shift JIS character string to Unicode character string convert instruction (without byte order mark) is supported.	"1.240" and above	"1.075D" and above	MELSEC iQ-F FX5 Programming Manual (Instructions, Standard Functions/Function Blocks)
Shift JIS character string to Unicode convert instruction (with byte order mark) is supported.	"1.240" and above	"1.075D" and above	MELSEC iQ-F FX5 Programming Manual (Instructions, Standard Functions/Function Blocks)
Retrieving FTP client files instruction is supported.	"1.240" and above	"1.075D" and above	MELSEC iQ-F FX5 Programming Manual (Instructions, Standard Functions/Function Blocks)
File acquisition from FTP server is supported.	"1.210" and above	"1.065T" and above	MELSEC iQ-F FX5 User's Manual (Ethernet Communication)
The following modules are supported. • FX5-4A-ADP	"1.240" and above	"1.075D" and above	MELSEC iQ-F FX5 User's Manual (Analog Control - CPU module built-in, Expansion adapter)

- *1 Supported with CPU module serial No. 158**** and above.
- *2 Data memory (device comment file) save/recovery is supported with "1.030" and later.
Data memory (device comment file) recovery retry is supported with "1.045" and later.
File password setting for the firmware update prohibited file is supported with "1.045" and later.
Data memory (restored information files, parameter files) save/recovery/recovery retry is supported with "1.060" and later.
- *3 Writing firmware update prohibited files is supported with "1.030G" and later.
- *4 Supported with CPU module serial No. 16Y**** and above.
- *5 Indicates the compatible software version of CPU Module Logging Configuration Tool and GX LogViewer.
- *6 Saving the event history file to the SD memory card is supported from CPU module serial No. 16Y**** and later.
- *7 Write the file, delete the file, remote password and file password is supported with "1.050" and later.
- *8 Data backup function is supported from CPU module serial No. 16Y**** and later.
The data memory for the backup/restoration target data is supported from "1.050" and later.
- *9 GX Works3: "1.040S" and above
GX LogViewer: "1.76E" and above
- *10 ERREAD, ERWRITE, ERINIT instruction is supported from CPU module serial No. 16Y**** and later.
- *11 Supported from the firmware version 1.010 and later of FX5-20PG-P and FX5-20PG-D.
- *12 Supported with CPU module serial No. 17X**** and above.

Restriction

- To update the firmware of the CPU module to version "1.100" or later, use the CPU module with serial No. as follows.
 - FX5UC-32MT/DS-TS and FX5UC-32MT/DSS-TS: Serial No. 178****
 - FX5U/FX5UC CPU module other than the above: Serial No. 17X****
- For the FX5U/FX5UC CPU module with the serial No. 2114001 or later, downgrading to previous firmware version "1.220" or earlier cannot be performed. Update error (3040H) will occur and the firmware will not be updated.
- For the FX5UJ CPU module with the serial No. 2154001 or later, downgrading to previous firmware version "1.010" or earlier cannot be performed. Update error (3040H) will occur and the firmware will not be updated.



INDEX

A

Annunciator (F) 352

B

Block password 219
Boot operation 139
Built-in analog 346

C

Character string constant 373
Clock function 68
Constant 372
Constant scan 114
Continuous logging 146
Counter (C/LC) 358
CPU Module Logging Configuration Tool 166
CPU parameter 523

D

Data logging file 153
Data memory 41
Data register (D) 360
Decimal 372
Decimal constant (K) 372
Device initial value 130
Device/label access service processing setting 141
Device/label memory 42

E

END processing 19
ERINIT instruction 364
ERREAD instruction 364
Error code 472
ERWRITE instruction 364
Event execution type program 28
Execution type of program 22

F

File password 219
File register (R/ER) 364
Files 45
Fixed scan execution mode 26
Fixed scan execution type program 23
FX3-compatible high-speed counter 292
FX3-compatible pulse catch 325

G

Global pointer 369
GX Logviewer 166

H

Hexadecimal 372
Hexadecimal constant (H) 372
High-speed comparison table 244
High-speed counter 220
High-speed counter (normal mode) 236
High-speed counter
(pulse density measurement mode) 239
High-speed counter
(rotational speed measurement mode) 242
High-speed timer 355

I

I/O refresh 19
Index register setting 363
Index registers (Z/LZ) 362
Indirect specification 371
Initial device value 130
Initial execution type program 22
Initial scan time 20
Input (X) 351
Internal buffer 164
Internal buffer capacity setting 128
Internal relay (M) 352
Interrupt cause 369
Interrupt pointer (I) 369
Interrupt priority 370
Interrupt program 33
IP filter 219

L

Label 374
Latch 132
Latch (1) 132
Latch (2) 132
Latch clear 135
Latch relay (L) 352
Link register (W) 360
Link relay (B) 352
Link special register (SW) 360
Link special relay (SB) 354
LOGTRG instruction 152
LOGTRGR instruction 173
Low-speed timer 355

M

Memory card parameter 532
Memory configuration 41
Memory dump file 184
Memory dump function 179
Memory dump status 184
Missing data 172
Module access device 361
Module parameter 524
Multiple interrupt 75
Multiple point output, high-speed comparison table
. 247

N

Nesting (N) 368

O

Online change 72
Operation at the time of a transition to RUN 165
Output (Y) 351

P

PAUSE 39
PID control 77
Pointer (P) 368
Priority for interrupt cause 370
Pulse catch 319
Pulse width measurement 302
PWM 332

R

Real constant (E) 372
Remote operation 116
Remote password 219
Remote PAUSE 118
Remote RESET 119
Remote RUN 116
Remote STOP 116
Retentive timer (ST) 355
Routine timer 355
RUN status 39

S

Scan execution type program 23
Scan monitoring function 66
Scan time 20
Scan time monitoring time setting 66
SD memory card 44
SD memory card forced stop 137
Security function 219
Security key authentication 219
SFC Block Device (BL) 371
SFC Transition Device (TR) 371
Special register (SD) 360
Special relay (SM) 360
Stand-by type program 31
Step relay (S) 354
STOP status 39
Storage file 163
Subroutine program 32
System clock 71
System device 360
System parameter 523

T

Time setting 68
Time zone 70
Timer (T/ST) 355
Trigger condition 152
Trigger instruction 152
Trigger logging 146

U

User device 351

W

Watchdog timer 66

MEMO

REVISIONS

Revision date	Revision	Description
October 2014	A	First Edition
January 2015	B	<p>■Added functions Fixed scan execution type program, Online change, PID control function, FX3-compatible high-speed counter function, Routine timer</p> <p>■Added or modified parts Section 1.3, 3.1, 3.2, Chapter 4, 7, 8, 9, 12, 13, 17, Section 19.2, Chapter 20, Section 21.2, Appendix 1, 2, 3, 4</p>
April 2015	C	A part of the cover design is changed.
May 2016	D	<p>■Added modules FX5U-32MR/DS, FX5U-32MT/DS, FX5U-32MT/DSS, FX5UC-64MT/D, FX5UC-64MT/DSS, FX5UC-96MT/D, FX5UC-96MT/DSS, FX5-16ET/ES-H, FX5-16ET/ESS-H</p> <p>■Added or modified parts RELEVANT MANUALS, TERMS, Section 1.1, 1.5, Chapter 4, Section 7.1, Section 9.3, 9.6, 9.8, 11.1, Chapter 12, Section 14.2, 15.1, Chapter 18, 19, Section 21.2, 21.4, 21.7, 21.9, 21.10, Chapter 22, Appendix, WARRANTY</p>
October 2016	E	<p>■Added modules FX5U-64MR/DS, FX5U-64MT/DS, FX5U-64MT/DSS, FX5U-80MR/DS, FX5U-80MT/DS, FX5U-80MT/DSS</p> <p>■Added functions Firmware update function, Data logging function, Event history function, Internal buffer capacity setting</p> <p>■Added or modified parts Terms, Section 1.1, 1.4, 1.5, 3.1, 3.2, Chapter 4, 5, 7, Section 10.3, 10.5, 10.6, 10.7, 10.8, 12.1, 13.2, Chapter 14, Section 17.1, Chapter 19, 20, Section 22.1, 23.2, 24.2, Appendix 1, 2, 3, 4, 5, 6, 7, 9</p>
October 2016	F	<p>■Added or modified parts Chapter 5, Section 19.2</p>
January 2017	G	<p>■Added functions Data backup/restoration function</p> <p>■Added or modified parts Section 3.2, Chapter 4, 5, Section 7.1, 8.1, 17.1, Chapter 19, Section 20.2, Chapter 21, Section 23.1, Appendix 1, 2, 3, 9</p>
April 2017	H	<p>■Added functions Memory dump function</p> <p>■Added or modified parts RELEVANT MANUALS, TERMS, Chapter 3, 4, 14, Section 17.1, Chapter 19, 20, 22, Appendix 1, 2, 3, 4, 9</p>
October 2017	J	<p>■Added functions Real-time monitor function, extended file register</p> <p>■Added or modified parts RELEVANT MANUALS, TERMS, Chapter 3, 4, 5, 14, Section 17.1, 20.4, Chapter 21, 23, Section 25.1, 27.1, 27.6, Appendix 1, 2, 3, 4, 9</p>
April 2018	K	<p>■Added functions Keep of latch label during PC write</p> <p>■Added or modified parts Section 10.8, 16.5, 22.1, Appendix 1, 2, 3, 4, 8, 9</p>
July 2018	L	<p>■Added or modified parts TERMS, Chapter 4, 5, Section 8.1, Chapter 14, Section 18.2, 24.2, 26.1, 26.2, 26.3, 26.6, 28.2, 28.9, Appendix 1, 3, 4, 9</p>
November 2018	M	<p>■Added or modified parts RELEVANT MANUALS, TERMS, Section 3.1, 3.3, Chapter 4, 5, Section 12.1, 12.2, 12.3, Chapter 13, 19, Section 23.2, 24.2, Appendix 1, 2, 3, 4, 5, 9</p>
October 2019	N	<p>■Added modules FX5UJ-24MR/ES, FX5UJ-24MT/ES, FX5UJ-24MT/ESS, FX5UJ-40MR/ES, FX5UJ-40MT/ES, FX5UJ-40MT/ESS, FX5UJ-60MR/ES, FX5UJ-60MT/ES, FX5UJ-60MT/ESS, FX5UC-32MT/DS-TS, FX5UC-32MT/DSS-TS, FX5UC-32MR/DS-TS</p> <p>■Added or modified parts RELEVANT MANUALS, TERMS, Section 1.1, 1.4, 1.5, 3.1, 3.2, 3.3, Chapter 4, 5, Section 6.1, 7.1, 7.2, Chapter 9, Section 10.8, Chapter 11, Section 12.3, Chapter 13, 14, 15, Section 16.1, 17.2, 17.3, 18.2, Chapter 19, Section 20.1, 20.2, 20.13, 21.4, 21.7, 21.9, 23.1, 23.2, Chapter 24, 25, 26, Section 27.2, 28.2, 28.5, 28.9, Appendix 1, 2, 3, 7, 9, TRADEMARKS</p>

Revision date	Revision	Description
May 2020	P	<ul style="list-style-type: none"> ■Added functions Data logging function (CSV file output format) ■Added or modified parts RELEVANT MANUALS, TERMS, Section 3.2, Chapter 4, Section 10.2, Chapter 13, 20, Section 24.1, 24.2, 26.6, Appendix 1, 2, 3, 4, 6, 7, 9, TRADEMARKS
August 2020	Q	<ul style="list-style-type: none"> ■Added or modified parts SAFETY PRECAUTIONS, WARRANTY
October 2020	R	<ul style="list-style-type: none"> ■Added or modified parts RELEVANT MANUALS, Section 1.4, 1.5, Chapter 2, Section 3.2, Chapter 4, 5, Section 8.1, Chapter 21, Section 23.1, Chapter 24, Section 26.1, 26.2, 28.1, 28.2, 28.10, 28.11, Appendix 1, 2, 3, 4, 5, 6, 9
January 2021	S	<ul style="list-style-type: none"> ■Added or modified parts Section 3.1, Chapter 5, Section 21.4, 28.5, 28.12, Appendix 9
April 2021	T	<ul style="list-style-type: none"> ■Added functions Firmware update function using engineering tool ■Added or modified parts RELEVANT MANUALS, TERMS, Section 3.2, Chapter 5, 20, Section 28.13, Appendix 1, 2, 3, 7, 9

This manual confers no industrial property rights or any rights of any other kind, nor does it confer any patent licenses. Mitsubishi Electric Corporation cannot be held responsible for any problems involving industrial property rights which may occur as a result of using the contents noted in this manual.

© 2014 MITSUBISHI ELECTRIC CORPORATION

WARRANTY

Please confirm the following product warranty details before using this product.

1. Gratis Warranty Term and Gratis Warranty Range

If any faults or defects (hereinafter "Failure") found to be the responsibility of Mitsubishi occurs during use of the product within the gratis warranty term, the product shall be repaired at no cost via the sales representative or Mitsubishi Service Company. However, if repairs are required onsite at domestic or overseas location, expenses to send an engineer will be solely at the customer's discretion. Mitsubishi shall not be held responsible for any re-commissioning, maintenance, or testing on-site that involves replacement of the failed module.

[Gratis Warranty Term]

The gratis warranty term of the product shall be for one year after the date of purchase or delivery to a designated place. Note that after manufacture and shipment from Mitsubishi, the maximum distribution period shall be six (6) months, and the longest gratis warranty term after manufacturing shall be eighteen (18) months. The gratis warranty term of repair parts shall not exceed the gratis warranty term before repairs.

[Gratis Warranty Range]

- (1) The range shall be limited to normal use within the usage state, usage methods and usage environment, etc., which follow the conditions and precautions, etc., given in the instruction manual, user's manual and caution labels on the product.
- (2) Even within the gratis warranty term, repairs shall be charged for in the following cases.
 1. Failure occurring from inappropriate storage or handling, carelessness or negligence by the user. Failure caused by the user's hardware or software design.
 2. Failure caused by unapproved modifications, etc., to the product by the user.
 3. When the Mitsubishi product is assembled into a user's device, Failure that could have been avoided if functions or structures, judged as necessary in the legal safety measures the user's device is subject to or as necessary by industry standards, had been provided.
 4. Failure that could have been avoided if consumable parts (battery, backlight, fuse, etc.) designated in the instruction manual had been correctly serviced or replaced.
 5. Relay failure or output contact failure caused by usage beyond the specified life of contact (cycles).
 6. Failure caused by external irresistible forces such as fires or abnormal voltages, and failure caused by force majeure such as earthquakes, lightning, wind and water damage.
 7. Failure caused by reasons unpredictable by scientific technology standards at time of shipment from Mitsubishi.
 8. Any other failure found not to be the responsibility of Mitsubishi or that admitted not to be so by the user.

2. Onerous repair term after discontinuation of production

- (1) Mitsubishi shall accept onerous product repairs for seven (7) years after production of the product is discontinued.
Discontinuation of production shall be notified with Mitsubishi Technical Bulletins, etc.
- (2) Product supply (including repair parts) is not available after production is discontinued.

3. Overseas service

Overseas, repairs shall be accepted by Mitsubishi's local overseas FA Center. Note that the repair conditions at each FA Center may differ.

4. Exclusion of loss in opportunity and secondary loss from warranty liability

Regardless of the gratis warranty term, Mitsubishi shall not be liable for compensation to:

- (1) Damages caused by any cause found not to be the responsibility of Mitsubishi.
- (2) Loss in opportunity, lost profits incurred to the user by Failures of Mitsubishi products.
- (3) Special damages and secondary damages whether foreseeable or not, compensation for accidents, and compensation for damages to products other than Mitsubishi products.
- (4) Replacement by the user, maintenance of on-site equipment, start-up test run and other tasks.

5. Changes in product specifications

The specifications given in the catalogs, manuals or technical documents are subject to change without prior notice.

6. Product application

- (1) In using the Mitsubishi MELSEC programmable controller, the usage conditions shall be that the application will not lead to a major accident even if any problem or fault should occur in the programmable controller device, and that backup and fail-safe functions are systematically provided outside of the device for any problem or fault.
- (2) The Mitsubishi programmable controller has been designed and manufactured for applications in general industries, etc. Thus, applications in which the public could be affected such as in nuclear power plants and other power plants operated by respective power companies, and applications in which a special quality assurance system is required, such as for railway companies or public service purposes shall be excluded from the programmable controller applications.
In addition, applications in which human life or property that could be greatly affected, such as in aircraft, medical applications, incineration and fuel devices, manned transportation, equipment for recreation and amusement, and safety devices, shall also be excluded from the programmable controller range of applications. However, in certain cases, some applications may be possible, providing the user consults their local Mitsubishi representative outlining the special requirements of the project, and providing that all parties concerned agree to the special circumstances, solely at the user's discretion.
- (3) Mitsubishi shall have no responsibility or liability for any problems involving programmable controller trouble and system trouble caused by DoS attacks, unauthorized access, computer viruses, and other cyberattacks.

TRADEMARKS

Microsoft, Excel, Windows, Windows Vista, and Windows XP are either registered trademarks or trademarks of Microsoft Corporation in the United States and/or other countries.

Anywire and AnyWireASLINK are either registered trademarks or trademarks of Anywire Corporation.

Unicode is either a registered trademark or a trademark of Unicode, Inc. in the United States and other countries.

The company names, system names and product names mentioned in this manual are either registered trademarks or trademarks of their respective companies.

In some cases, trademark symbols such as [™] or [®] are not specified in this manual.

Manual number: JY997D55401T

Model: FX5-U-OU-E

Model code: 09R537

When exported from Japan, this manual does not require application to the Ministry of Economy, Trade and Industry for service transaction permission.

MITSUBISHI ELECTRIC CORPORATION

HEAD OFFICE: TOKYO BUILDING, 2-7-3 MARUNOUCHI, CHIYODA-KU, TOKYO 100-8310, JAPAN

Specifications are subject to change without notice.